

Wavelets and Wavelet Packets on Quantum Computers

Andreas Klappenecker

Department of Mathematics, Texas A&M University
College Station, TX, 77843-3368, USA
andreask@math.tamu.edu

ABSTRACT

We show how periodized wavelet packet transforms and periodized wavelet transforms can be implemented on a quantum computer. Surprisingly, we find that the implementation of wavelet packet transforms is less costly than the implementation of wavelet transforms on a quantum computer.

1. INTRODUCTION

Let H be a Hilbert space with orthonormal basis $\{e_k \mid k \in \mathbf{Z}\}$. Recall that we can construct a new basis of H by the following splitting trick.^{1,2} Let (α, β) be a QMF system in $\ell^2(\mathbf{Z})$, that is,

$$\{T_{2k} \alpha, T_{2k} \beta \mid k \in \mathbf{Z}\} \text{ is an orthonormal basis of } \ell^2(\mathbf{Z}),$$

where T_k denotes the translation operator $T_k(s_n)_n = (s_{n-k})_n$. For simplicity, we will also assume that α, β are finitely supported. Then we obtain a new orthonormal basis $\{f_k \mid k \in \mathbf{Z}\}$ of H by defining

$$f_{2k} = \sum_{l \in \mathbf{Z}} \alpha_{2k-l} e_l, \quad f_{2k+1} = \sum_{l \in \mathbf{Z}} \beta_{2k-l} e_l,$$

where $\alpha = (\alpha_k)_k$ and $\beta = (\beta_k)_k$.

This splitting trick is used several times in wavelet and wavelet packet algorithms. We may start with, say, the basis $e_k = \delta_k$, $k \in \mathbf{Z}$, where δ_k is the sequence with value 1 at k and 0 elsewhere. Applying the splitting trick, we obtain two closed subspaces A and D of H . Namely, the closed subspace A of H generated by $\{f_{2k} \mid k \in \mathbf{Z}\}$, and the closed subspace D of H generated by $\{f_{2k+1} \mid k \in \mathbf{Z}\}$. We may split A or D as well. After a finite number of splitting steps, we have a new basis of H . The advantage is that the coordinate change can be computed rather rapidly with quadrature mirror filter banks.

On a classical computer one tends to minimize the number of splitting steps, mainly to reduce the cost of the computation. The wavelet algorithms split only the spaces A again. As a result, we obtain an algorithm with linear complexity on a classical computer. The wavelet packet algorithms always split both spaces A and D , leading to $O(n \log n)$ operations on a classical computer. Surprisingly, we will see that the implementation of wavelet packet algorithms is less costly on a quantum computer than the implementation of wavelet algorithms.

In the next two sections we give a more or less self-contained introduction to quantum circuits. Then we show how the Walsh-Hadamard transform can be realized on a quantum computer. This

is the simplest version of a wavelet packet transform. The rough architecture of wavelet packet and wavelet transforms is described in section 5. We give a realization of the splitting step in section 6.

Notation. We denote by $\ell^2(\mathbf{Z}/N\mathbf{Z})$ the complex vector space \mathbf{C}^N equipped with the usual inner product. This vector space should be thought of as a periodized version of $\ell^2(\mathbf{Z})$. Thus a vector in $\ell^2(\mathbf{Z}/N\mathbf{Z})$ is given by a complex-valued sequence $(s_n)_{n \in \mathbf{Z}/N\mathbf{Z}}$.

2. QUANTUM GATES

A quantum bit, or shortly qubit, takes a value in the complex two-dimensional vector space \mathbf{C}^2 . The standard basis of \mathbf{C}^2 is given by two orthogonal vectors, denoted by $|0\rangle$ and $|1\rangle$. Dirac's "ket" notation is traditionally used to describe the state of a quantum system. The labeling is chosen to resemble the values 0 and 1 of a classical bit. However, the state of a qubit can be described by a complex linear combination $a|0\rangle + b|1\rangle$, unlike the classical case.

In classical computation, all operations on a single bit are given by the identity mapping and the *not* operation. In the quantum world, the state of a qubit can be transformed by a unitary operation. This includes the *not* operation $U_X|0\rangle = |1\rangle$, $U_X|1\rangle = |0\rangle$, but also many others. We write qubits as column vectors, and operate on these vectors by left multiplication with unitary matrices. We express single bit operations with respect to the basis $\{|0\rangle, |1\rangle\}$ unless otherwise specified. Some of the operations that will be used in the following can be described by the action of the matrices:

$$X = \begin{pmatrix} 0 & 1 \\ 1 & 0 \end{pmatrix}, \quad H = \frac{1}{\sqrt{2}} \begin{pmatrix} 1 & 1 \\ 1 & -1 \end{pmatrix}, \quad R(\theta) = \begin{pmatrix} \cos \theta & \sin \theta \\ -\sin \theta & \cos \theta \end{pmatrix}.$$

The matrix X corresponds to the *not* operation U_X . The operation U_H , corresponding to the left multiplication by H , acts on the classical states by

$$U_H|0\rangle = \frac{1}{\sqrt{2}}|0\rangle + \frac{1}{\sqrt{2}}|1\rangle, \quad U_H|1\rangle = \frac{1}{\sqrt{2}}|0\rangle - \frac{1}{\sqrt{2}}|1\rangle.$$

The operator U_H has no classical counterpart.

A finite collection of qubits is called a quantum register, or simply register. The state of a register consisting of n qubits can be described by an element of the $(n - 1)$ -fold tensor product $V = \mathbf{C}^2 \otimes \mathbf{C}^2 \otimes \cdots \otimes \mathbf{C}^2$, a complex vector space of dimension 2^n . This remarkable property follows from the fundamental principle of quantum physics, which asserts that the joint state of two quantum systems is the tensor product of their individual quantum state spaces.

Consider a register with two quantum bits. A state of this register can be expressed with respect to the basis $B = (|0\rangle \otimes |0\rangle, |0\rangle \otimes |1\rangle, |1\rangle \otimes |0\rangle, |1\rangle \otimes |1\rangle)$. Suppose we apply the single bit operation U_H on the second (rightmost) qubit. This operation acts on the state vector of the register by left multiplication with the matrix

$$I_2 \otimes H = \frac{1}{\sqrt{2}} \begin{pmatrix} 1 & 1 & 0 & 0 \\ 1 & -1 & 0 & 0 \\ 0 & 0 & 1 & 1 \\ 0 & 0 & 1 & -1 \end{pmatrix}.$$

The single bit operations are considered as elementary operation on a quantum computer. On a classical computer it can be a formidable task to simulate these elementary operations, especially if the register consists of a large number of qubits.

The notation of elements in the vector space V is a little bit cumbersome. We want to write for example $|1\rangle \otimes |0\rangle \otimes |0\rangle$ more compactly as $|100\rangle$. For that reason, we fix an orthonormal basis of \mathbf{C}^{2^n} , and denote the basis elements by $|x\rangle$, where x is a binary vector in \mathbf{F}_2^n . We map the vector space V isomorphically onto \mathbf{C}^{2^n} by

$$|a_{n-1}\rangle \otimes \cdots \otimes |a_1\rangle \otimes |a_0\rangle \mapsto |a_{n-1} \dots a_1 a_0\rangle,$$

where the a_i are elements of the finite field \mathbf{F}_2 . We will refer to a_0 as the lowest significant bit, and to a_{n-1} as the highest significant bit. We apply this isomorphism without further notice whenever it is convenient.

Apart from the single bit operations, we need operations manipulating several qubits. The *controlled not* gate manipulates two qubits, and is also considered as an elementary operation in quantum computing. The controlled not gate corresponds to a reversible version of the classical *xor* gate. It operates on the basis states by

$$\begin{array}{lcl} |0\rangle \otimes |0\rangle & \mapsto & |0\rangle \otimes |0\rangle & & |00\rangle & \mapsto & |00\rangle \\ |0\rangle \otimes |1\rangle & \mapsto & |0\rangle \otimes |1\rangle & & |01\rangle & \mapsto & |01\rangle \\ |1\rangle \otimes |0\rangle & \mapsto & |1\rangle \otimes |1\rangle & \text{or} & |10\rangle & \mapsto & |11\rangle \\ |1\rangle \otimes |1\rangle & \mapsto & |1\rangle \otimes |0\rangle & & |11\rangle & \mapsto & |10\rangle \end{array}$$

If the highest significant bit is 1, then the state of the lowest significant bit is flipped, that is, $|a_1 a_0\rangle \mapsto |a_1 a_1 \oplus a_0\rangle$. We refer to the most significant bit as the *control bit* and to the least significant bit as the *target bit* of the controlled not gate. More generally, we can take two different qubits, take one as a control bit and the other as a target bit. This way we obtain a controlled not gate on n quantum bits. We will see some examples shortly.

The single bit gates and the controlled not bit gates are universal in the sense that any unitary operator in \mathbf{C}^{2^n} can be realized by a composition of these gates.³

3. QUANTUM CIRCUITS

Feynman introduced a graphical notation for quantum gates.^{4,5,3,6} It is convenient to specify simple quantum circuits in this notation. The not gate U_X with input A and output A' is denoted by

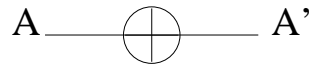

A more general single bit gate U_M is represented by



A conditional not gate with two input A and B is denoted in the following way:

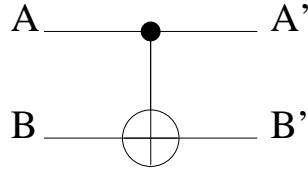

The input A controls the not operation on B . We adopt the convention that the upper bit A in the graphical notation corresponds to the most significant (leftmost) bit, and that the lower bit B corresponds to the least significant bit. Thus, the conditional not gate shown above operates as described in the previous section.

Similarly, we may apply a not operation on the lowest significant bit if the highest significant bit is zero. The control bit is then given by a non-filled circle in the graphical notation:

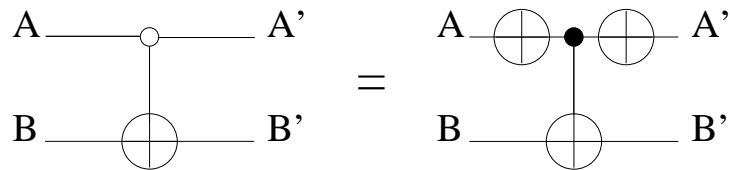

In other words, the behaviour of this gate can be described by the map

$$\begin{array}{l}
 |00\rangle \mapsto |01\rangle \\
 |01\rangle \mapsto |00\rangle \\
 |10\rangle \mapsto |10\rangle \\
 |11\rangle \mapsto |11\rangle
 \end{array}
 \quad
 \overline{\text{CNOT}} := \begin{pmatrix} 0 & 1 & 0 & 0 \\ 1 & 0 & 0 & 0 \\ 0 & 0 & 1 & 0 \\ 0 & 0 & 0 & 1 \end{pmatrix}.$$

As a convenient shorthand, we will use multiply conditioned single bit gates. For example, the following gate applies the single bit operation U_M on the least significant bit, if the higher significant bits A_1, A_2, A_3 are 1, 0, 1 respectively.

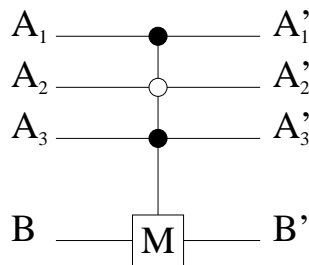

It is well-known that such a multiply conditioned gate can be constructed with $\Theta(n)$ elementary gates, if we allow one additional qubit for temporary calculations.³ We will always assume that enough additional (ancilla) qubits are available.

4. THE WALSH-HADAMARD TRANSFORM

The Walsh-Hadamard transform is a simple example of a wavelet packet transform. The quantum circuit is particularly simple in this case, yet it shows some features of more complex wavelet packet transforms.

The Walsh-Hadamard transform H_{2^n} for vectors of length 2^n can be defined inductively by

$$H_2 = H = \frac{1}{\sqrt{2}} \begin{pmatrix} 1 & 1 \\ 1 & -1 \end{pmatrix}, \quad \text{and} \quad H_{2^n} = H_2 \otimes H_{2^{n-1}} \quad \text{for} \quad n \geq 2.$$

It is well-known⁷ that H_{2^n} can be factored as follows:

$$H_{2^n} = M_{2^n}^{(n)} M_{2^n}^{(n-1)} \cdots M_{2^n}^{(1)}, \quad \text{where} \quad M_{2^n}^{(k)} = I_{2^{n-k}} \otimes H \otimes I_{2^{k-1}}, \quad (1)$$

and I_n is an $n \times n$ unit matrix. We can directly translate this factorization into a quantum circuit. Equation (1) says that we have to apply U_H on each qubit, starting with the least significant bit. The following figure shows this circuit for signals of length 8:

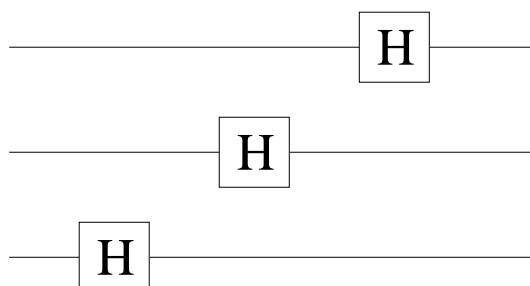

The circuit is read like a musical score from left to right. We merely need three elementary operations on a quantum computer. This circuit realizes the matrix product below (which should be read from right to left, since we agreed to act by left multiplication on the state vector of a quantum register):

$$\frac{1}{\sqrt{8}} \begin{pmatrix} 1 & \cdot & \cdot & \cdot & 1 & \cdot & \cdot & \cdot \\ \cdot & 1 & \cdot & \cdot & \cdot & 1 & \cdot & \cdot \\ \cdot & \cdot & 1 & \cdot & \cdot & \cdot & 1 & \cdot \\ \cdot & \cdot & \cdot & 1 & \cdot & \cdot & \cdot & 1 \\ 1 & \cdot & \cdot & \cdot & - & \cdot & \cdot & \cdot \\ \cdot & 1 & \cdot & \cdot & \cdot & - & \cdot & \cdot \\ \cdot & \cdot & 1 & \cdot & \cdot & \cdot & - & \cdot \\ \cdot & \cdot & \cdot & 1 & \cdot & \cdot & \cdot & - \end{pmatrix} \begin{pmatrix} 1 & \cdot & 1 & \cdot & \cdot & \cdot & \cdot & \cdot \\ \cdot & 1 & \cdot & 1 & \cdot & \cdot & \cdot & \cdot \\ 1 & \cdot & - & \cdot & \cdot & \cdot & \cdot & \cdot \\ \cdot & 1 & \cdot & - & \cdot & \cdot & \cdot & \cdot \\ \cdot & \cdot & \cdot & \cdot & 1 & \cdot & 1 & \cdot \\ \cdot & \cdot & \cdot & \cdot & \cdot & 1 & \cdot & 1 \\ \cdot & \cdot & \cdot & \cdot & 1 & \cdot & - & \cdot \\ \cdot & \cdot & \cdot & \cdot & \cdot & 1 & \cdot & - \end{pmatrix} \begin{pmatrix} 1 & 1 & \cdot & \cdot & \cdot & \cdot & \cdot & \cdot \\ 1 & - & \cdot & \cdot & \cdot & \cdot & \cdot & \cdot \\ \cdot & \cdot & 1 & 1 & \cdot & \cdot & \cdot & \cdot \\ \cdot & \cdot & 1 & - & \cdot & \cdot & \cdot & \cdot \\ \cdot & \cdot & \cdot & \cdot & 1 & 1 & \cdot & \cdot \\ \cdot & \cdot & \cdot & \cdot & 1 & - & \cdot & \cdot \\ \cdot & \cdot & \cdot & \cdot & \cdot & \cdot & 1 & 1 \\ \cdot & \cdot & \cdot & \cdot & \cdot & \cdot & \cdot & 1 - \end{pmatrix}$$

The dots denote 0 and $-$ is short for -1 .

We obtain a considerable speedup for larger values of n . While about $n2^n$ operations are needed on a classical computer, only n elementary operations are needed on a quantum computer. The fast Walsh-Hadamard transform is an essential ingredient of Simon's algorithm.⁸

5. WAVELET PACKET TRANSFORMS

The state space of a quantum computer is large, but finite dimensional. For simplicity, I decided to discuss only periodic (also known as cyclic) wavelet packet transforms. Thus, signals and filters are regarded as periodic sequences. The benefit is that we obtain rather simple quantum circuits. Other methods of border treatment will in general increase the complexity of the implementation. Since adding a single quantum bit allows us to double the signal length, it is easy to emulate non-periodic versions by choosing a large signal period.

Let us recast the splitting trick for finite dimensions. Let H a finite dimensional Hilbert space with orthonormal basis $\{e_k \mid k \in \mathbf{Z}/2N\mathbf{Z}\}$. Let (α, β) a QMF system of $\ell^2(\mathbf{Z}/2N\mathbf{Z})$, that is,

$$\{T_{2k}\alpha, T_{2k}\beta \mid k \in [0:N-1]\} \text{ is an orthonormal basis of } \ell^2(\mathbf{Z}/2N\mathbf{Z}),$$

where $T_k e_n = e_{k+n}$ for all $n \in \mathbf{Z}/2N\mathbf{Z}$.

We obtain a new orthonormal basis $\{f_k \mid k \in \mathbf{Z}/2N\mathbf{Z}\}$ of H by defining

$$f_{2k} = \sum_n \alpha_{n-2k} e_n, \quad f_{2k+1} = \sum_n \beta_{n-2k} e_n,$$

where $\alpha = (\alpha_k)$ and $\beta = (\beta_k)$. The proof is an immediate consequence of the definitions.

Let me illustrate this for the case $N = 4$, that is, the dimension of H is 8. According to the splitting trick, we obtain the following base change matrix from (e_n) to (f_n) :

$$\begin{pmatrix} \alpha_0 & \beta_0 & . & . & . & . & \alpha_2 & \beta_2 \\ \alpha_1 & \beta_1 & . & . & . & . & \alpha_3 & \beta_3 \\ \alpha_2 & \beta_2 & \alpha_0 & \beta_0 & . & . & . & . \\ \alpha_3 & \beta_3 & \alpha_1 & \beta_1 & . & . & . & . \\ . & . & \alpha_2 & \beta_2 & \alpha_0 & \beta_0 & . & . \\ . & . & \alpha_3 & \beta_3 & \alpha_1 & \beta_1 & . & . \\ . & . & . & . & \alpha_2 & \beta_2 & \alpha_0 & \beta_0 \\ . & . & . & . & \alpha_3 & \beta_3 & \alpha_1 & \beta_1 \end{pmatrix}$$

Assume that we are given the signal as a component vector with respect to the base (e_n) . Then the splitting step corresponds to left multiplication with the matrix

$$\begin{pmatrix} \bar{\alpha}_0 & \bar{\alpha}_1 & \bar{\alpha}_2 & \bar{\alpha}_3 & . & . & . & . \\ \bar{\beta}_0 & \bar{\beta}_1 & \bar{\beta}_2 & \bar{\beta}_3 & . & . & . & . \\ . & . & \bar{\alpha}_0 & \bar{\alpha}_1 & \bar{\alpha}_2 & \bar{\alpha}_3 & . & . \\ . & . & \bar{\beta}_0 & \bar{\beta}_1 & \bar{\beta}_2 & \bar{\beta}_3 & . & . \\ . & . & . & . & \bar{\alpha}_0 & \bar{\alpha}_1 & \bar{\alpha}_2 & \bar{\alpha}_3 \\ . & . & . & . & \bar{\beta}_0 & \bar{\beta}_1 & \bar{\beta}_2 & \bar{\beta}_3 \\ \bar{\alpha}_2 & \bar{\alpha}_3 & . & . & . & . & \bar{\alpha}_0 & \bar{\alpha}_1 \\ \bar{\beta}_2 & \bar{\beta}_3 & . & . & . & . & \bar{\beta}_0 & \bar{\beta}_1 \end{pmatrix}$$

Setting $\alpha_0 = \alpha_1 = \beta_0 = 1/\sqrt{2}$, $\beta_1 = -1/\sqrt{2}$, and all other coefficients zero, we recognize the first splitting step of the Walsh-Hadamard transform. The coefficients with even index contain the sum (approximation) and the coefficients with odd index contain the difference (detail).

We will see in the next section how such splitting matrices can be implemented. The next observation is essential for wavelet packet algorithms. Suppose we want to split both spaces $A = \text{span}\{T_k \alpha \mid k = 0, 2, 4, 6\}$ and $D = \text{span}\{T_k \beta \mid k = 0, 2, 4, 6\}$. Then we observe that *both* splitting

steps can be realized by the following tensor product of matrices:

$$\begin{pmatrix} \bar{\alpha}_0 & \bar{\alpha}_1 & \bar{\alpha}_2 & \bar{\alpha}_3 \\ \bar{\beta}_0 & \bar{\beta}_1 & \bar{\beta}_2 & \bar{\beta}_3 \\ \bar{\alpha}_2 & \bar{\alpha}_3 & \bar{\alpha}_0 & \bar{\alpha}_1 \\ \bar{\beta}_2 & \bar{\beta}_3 & \bar{\beta}_0 & \bar{\beta}_1 \end{pmatrix} \otimes I_2 = \begin{pmatrix} \bar{\alpha}_0 & \cdot & \bar{\alpha}_1 & \cdot & \bar{\alpha}_2 & \cdot & \bar{\alpha}_3 & \cdot \\ \cdot & \bar{\alpha}_0 & \cdot & \bar{\alpha}_1 & \cdot & \bar{\alpha}_2 & \cdot & \bar{\alpha}_3 \\ \bar{\beta}_0 & \cdot & \bar{\beta}_1 & \cdot & \bar{\beta}_2 & \cdot & \bar{\beta}_3 & \cdot \\ \cdot & \bar{\beta}_0 & \cdot & \bar{\beta}_1 & \cdot & \bar{\beta}_2 & \cdot & \bar{\beta}_3 \\ \bar{\alpha}_2 & \cdot & \bar{\alpha}_3 & \cdot & \bar{\alpha}_0 & \cdot & \bar{\alpha}_1 & \cdot \\ \cdot & \bar{\alpha}_2 & \cdot & \bar{\alpha}_3 & \cdot & \bar{\alpha}_0 & \cdot & \bar{\alpha}_1 \\ \bar{\beta}_2 & \cdot & \bar{\beta}_3 & \cdot & \bar{\beta}_0 & \cdot & \bar{\beta}_1 & \cdot \\ \cdot & \bar{\beta}_2 & \cdot & \bar{\beta}_3 & \cdot & \bar{\beta}_0 & \cdot & \bar{\beta}_1 \end{pmatrix}.$$

Assume that **SPLITn** is a quantum circuit realizing a splitting step for n -dimensional signals. Then the quantum circuit for a wavelet packet tree of depth two is shown below:

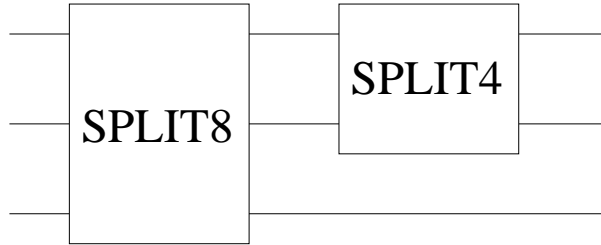

If we decide to realize only a splitting of the space A , then we have to condition **SPLIT4** in the following way:

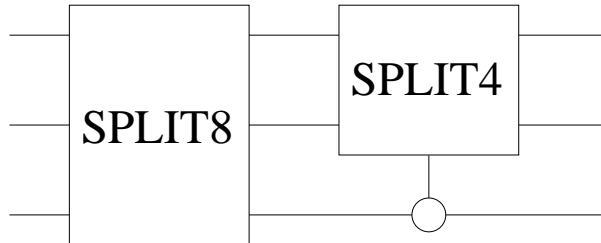

The conditioning means that we have to add this further condition to all gates (which is rather costly), or we have to prevent the circuit from changing the input in case the condition is not satisfied. There are several different ways to do that. I will indicate in the next section how the splitting steps can be conditioned.

6. THE SPLITTING STEP

The base change operator O from (e_n) to (f_n) satisfies a remarkable property:

$$f_0 = Oe_0, \quad f_1 = Oe_1,$$

and O commutes with the even translations $OT_2 = T_2O$. This follows from the property $T_{2k}f_0 = f_{2k}$ and $T_{2k}f_1 = f_{2k+1}$ of the basis (f_n) . On the other hand, it is clear that any unitary operator on H commuting with T_2 corresponds to a spitting trick construction.

Let us define a few simple operators commuting with T_2 . Denote by M a unitary 2×2 -matrix. Then the operator O_M , given by the matrix $I_N \otimes M$ with respect to the basis (e_n) , is easily seen to commute with T_2 . We refer to O_M as a local rotation operator. Note that the translation operator T_1 commutes with T_2 as well. We will construct our splitting steps as products of translation operators and local rotation operators.

Case $N = 2^n$. A circuit for the local rotation operator O_M is simply given by a single bit operation on the lowest significant input bit. We merely need to show how a circuit for $|m\rangle \mapsto |m + 1 \bmod 2^n\rangle$ can be constructed. In binary representation, this mapping can be specified in terms of the following operations in \mathbf{F}_2 :

$$|a_{n-1} \dots a_1 a_0\rangle \mapsto |b_{n-1} \dots b_1 b_0\rangle, \quad a_i, b_i \in \mathbf{F}_2,$$

with

$$\begin{aligned} b_0 &= a_0 + 1 \\ b_1 &= a_1 + a_0 \\ b_2 &= a_2 + c_1, & \text{where } c_1 &= a_1 a_0, \\ b_i &= a_i + c_{i-1}, & \text{where } c_{i-1} &= a_{i-1} c_{i-2}, \end{aligned}$$

for $3 \leq i \leq n - 1$. Allowing additional qubits for the calculation of the carries c_i , we obtain a particular simple implementation. Calculating the c_i 's and then the b_i 's, we obtain the following circuit for the case $n = 4$:

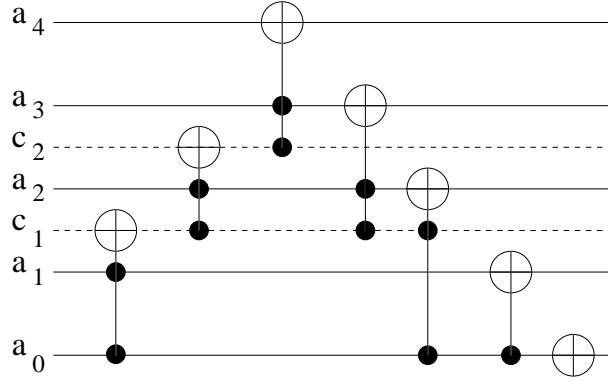

The qubits for the carries c_0 and c_1 are initially prepared in the state $|0\rangle$. Cleaning up operations of these ancilla bits are not shown.

LEMMA 6.1. *The translation operations $|m\rangle \mapsto |m + 1 \bmod 2^n\rangle$ and $|m\rangle \mapsto |m - 1 \bmod 2^n\rangle$ can be implemented with $O(n)$ elementary quantum gates, if additional qubits are allowed for temporary calculations.*

Proof. For $n \geq 3$, we need $n - 2$ Toffoli gates (conditional not gates with two conditions) for the calculation of the carries, the same number is needed to clean up the ancilla bits. One conditional not gate, one not gate, and $n - 1$ Toffoli gates are needed for the calculations of the b_i 's. How Toffoli gates can be expressed in terms of elementary gates is described in Barenco et. al.³ Running the circuit backwards yields a circuit for $|m\rangle \mapsto |m - 1 \bmod 2^n\rangle$. \square

Remark. For wavelet algorithms we need a conditioned form of circuits. The local rotation operation is simply a conditioned single bit gate. It is well-known how to express such a gate in terms of elementary gates.³ Conditioning of the translation operations is also easy. We just condition the gates with target c_1 , a_1 , and a_0 . Conditioning c_1 means that the carry does not ripple through, hence the higher significant bits are not changed. The gates with target bits a_1 and a_0 need to be conditioned to prevent a distortion of the two least significant bits.

General Case. Some modifications are needed if we want to implement a splitting step for signals of even length $2N$, N not a power of two. The basic idea is to embed H into a complex vector space of dimension 2^n , where $n := \lceil \log_2(2N) \rceil$. We assume that the input is given as a linear combination of $|0\rangle, \dots, |2N - 1\rangle$. We may still realize the local rotation operator by applying a single bit operation on the least significant qubit.

We realize the operation $|m\rangle \mapsto |m + 1 \bmod 2N\rangle$ as follows. Note that $|m\rangle \mapsto |m + 1 \bmod 2^n\rangle$ maps $|m\rangle$ to $|m + 1\rangle$, for $0 \leq m < 2N - 1$, just in the way we want it. Only $|2N - 1\rangle$ is mapped to $|2N\rangle$ instead of $|0\rangle$. We can take care of this exception by setting an additional qubit. Then we merely need to set all 1's in the binary representation of $2N$ to 0. For example, if we want to realize the circuit $|m\rangle \mapsto |m + 1 \bmod 6\rangle$, then we may take the circuit for $x \mapsto x + 1 \bmod 8$ and modify it in the following way:

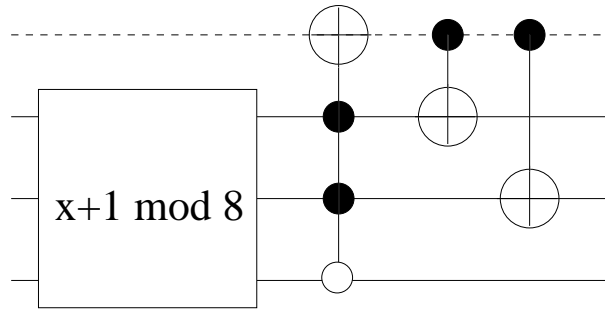

Here it is again assumed that the additional qubit is initially prepared in the state $|0\rangle$. Note that a $|m\rangle \mapsto |m + 1 \bmod 2N\rangle$ gate can still be implemented with $O(n)$ elementary gates.

Remarks:

1. Our construction of splitting steps is motivated by the parametrization of Holschneider and Pinkall^{9,10} of QMF systems of $\ell^2(\mathbf{Z})$. They essentially showed that any finitely supported QMF system can be obtained by applying local rotation and translation operators on (δ_0, δ_1) . Consequently, we can factor all QMF systems of $\ell^2(\mathbf{Z}/2N\mathbf{Z})$ that are periodized versions of QMF systems of $\ell^2(\mathbf{Z})$. See [11,12] for more details on this.
2. Note, however, that the parametrization is in general incomplete in the finite dimensional case. This is easy to see by looking at the polyphase matrices of our QMF filters. The determinant of a polyphase matrix obtained by our construction has trivial units in the group ring $\mathbf{C}[\mathbf{Z}/N\mathbf{Z}]$.

7. CONCLUSION

Suppose we want to compute either a wavelet or a wavelet packet transform on a quantum computer. Let us assume that each splitting step has the same number L of local rotation and translation operators. For example, this is the case if we take a periodized version of a fixed QMF system of $\ell^2(\mathbf{Z})$ at each step. Assuming that the signal can be represented by n qubits, then we have at most n (conditioned) splitting circuits to realize each transform. The complexity of each conditioned splitting step is at most $O(Ln)$. Hence at most $O(Ln^2)$ elementary gates are needed to realize the transform. Note that wavelet packet algorithms need fewer operations than wavelet algorithms on a quantum computer; this fact is hidden in the constant of the O -notation.

Let $N = 2^n$ be the length of the input signal. On a classical computer we need $O(N)$ operations for a wavelet transform and $O(N \log N)$ operations for a wavelet packet transform. On a quantum computer we merely need $O(\log^2 N)$ elementary quantum gate operations for a wavelet or a wavelet packet transform.

Acknowledgements. I wish to thank Professor Thomas Beth and Markus Grassl for introducing me to quantum computing.

APPENDIX A. PROGRAM

I have written a small perl program to simulate simple quantum gates. This toy is freely available from the following web site:

<http://www.math.tamu.edu/~Andreas.Klappenecker/>

The purpose of this program is only educational. It is my belief that the basic ideas of quantum circuits can be learned rather quickly. Playing around with this toy program may help in this process.

REFERENCES

1. Y. Meyer, *Les Ondelettes – Algorithmes et applications*, Armand Colin, 1992.
2. I. Daubechies, *Ten Lectures on Wavelets*, CBMS-NSF Reg. Conf. Series Appl. Math., SIAM, 1992.
3. A. Barenco, C. H. Bennett, R. Cleve, D. P. DiVincenzo, N. Margolus, P. Shor, T. Sleator, J. A. Smolin, and H. Weinfurter, “Elementary gates for quantum computation,” *Physical Review A* **52**(5), pp. 3457–3467, 1995.
4. R. P. Feynman, “Quantum mechanical computers,” *Optics news* **11**, 1982.
5. R. P. Feynman, *Feynman Lectures on Computation*, Addison-Wesley, 1996.
6. P. Høyer, “Efficient quantum transforms.” LANL preprint quant-ph/9702028, Feb. 1997.
7. F. J. MacWilliams and N. J. A. Sloane, *The Theory of Error Correcting Codes*, Elsevier Science B. V., Amsterdam, 1977.
8. D. R. Simon, “On the power of quantum computation,” in *Proceedings of the 35th Annual Symposium on Foundations of Computer Science*, pp. 116–123, Institute of Electrical and Electronic Engineers Computer Society Press, (Los Alamitos, CA), 1994.
9. M. Holschneider and U. Pinkall, “Quadratic mirror filters and loop groups.” Technical report, TU-Berlin, 1993.

10. M. Holschneider, *Wavelets – An Analysis Tool*, Oxford University Press, 1995.
11. A. Klappenecker, *Algebraische Wavelets*, Forschung und Wissen, GCA-Verlag, Herdecke, 1998. (Dissertation, Universität Karlsruhe).
12. A. Klappenecker, T. Beth, and M. Grassl, “Wavelettransformationen auf Quantenrechnern,” in *Informations- und Mikrosystemtechnik, Magdeburg, 25.–27. März 1998*, B. Michaelis and H. Holub, eds., pp. 145–152, Logisch-GmbH, 1998.