

# Interaction Representation in Boltzmann Field Theory

I.Ya.Aref'eva, \*

and

A.P.Zubarev †

## Abstract

We consider an interaction representation in the Boltzmann field theory. It describes the master field for a subclass of planar diagrams in matrix models, so called half-planar diagrams. This interaction representation was found in the previous paper by Accardi, Volovich and one of us (I.A.) and it has an unusual property that one deals with a rational function of the interaction Lagrangian instead of the ordinary exponential function. Here we study the interaction representation in more details and show that under natural assumptions this representation is in fact unique. We demonstrate that corresponding Schwinger-Dyson equations lead to a closed set of integral equations for two- and four-point correlation functions. Renormalization of the model is performed and renormalization group equations are obtained. Some model examples with discrete number of degrees of freedom are solved numerically. The solution for one degree of freedom is compared with the planar approximation for one matrix model. For large variety of coupling constant it reproduces the planar approximation with good accuracy.

---

\*Steklov Mathematical Institute, Vavilov 42, GSP-1, 117966, Moscow, e-mail: arefeva@class.mian.su

†Steklov Mathematical Institute, Vavilov 42, GSP-1, 117966, Moscow, e-mail: zubarev@class.mian.su

# 1 Introduction

There is an old problem in quantum field theory of finding the leading asymptotics in  $N \times N$  matrix models for large  $N$  in realistic space-time. Its solution may have important applications to hadron dynamics [1]-[4] since the large  $N$  limit in QCD ( $N$  is the number of colors) enables us to understand some phenomenological features of strong interaction.

In the early 80-s it was suggested [3] that there exists a master field  $\Phi(x)$  such that correlation functions of this field are equal to the large  $N$  limit of invariant correlation functions of a matrix field  $M(x)$ ,

$$\lim_{N \rightarrow \infty} \frac{1}{N^{1+n/2}} \langle \text{tr}(M(x_n) \dots M(x_1)) \rangle = \langle \Phi(x_n) \dots \Phi(x_1) \rangle. \quad (1.1)$$

The problem of the construction of the master field has been discussed in many works, see for example [5]-[18]. Gopakumar and Gross [19] and Douglas [20] have constructed the master field for an arbitrary matrix model in terms of correlation functions by using methods of non-commutative probability theory [21]-[23]. There has been a problem of the construction an operator realization for the master field without knowledge of correlation functions. Recently this problem has been solved in [24] and it was shown that the master fields satisfy to standard equations of relativistic field theory but fields are quantized according to a new rule. These fields have a realization in the free (Boltzmannian) Fock space.

Quantum field theory in the Boltzmannian Fock space has been considered in [25, 19, 26, 24, 27, 28]. Some special form of this theory realizes the master field for a subset of planar diagrams, for the so called half-planar diagrams. This construction deals with the master field in a modified interaction representation in the free Fock space. This new interaction representation involves not the ordinary exponential function of the interaction but a rational function of the interaction and correlation functions are given by the formula

$$\begin{aligned} \langle \Phi(x_m) \dots \Phi(x_1) \rangle &= \langle 0 | \phi(x_m) \dots \phi(x_1) | \Omega \rangle, \quad | \Omega \rangle = \Omega | 0 \rangle \\ \Omega &= \frac{1}{1 + S_{int}(\phi)}, \end{aligned} \quad (1.2)$$

where  $\phi(x)$  is a field in the free (Boltzmannian) Fock space,

$$\phi(x) = \phi^-(x) + \phi^+(x), \quad (1.3)$$

satisfying the relation

$$\phi^-(x) \phi^+(y) = \Delta(x - y), \quad (1.4)$$

where  $\Delta(x - y)$  is the free propagator and  $\phi^- | 0 \rangle = 0$ .

In this paper we study the Boltzmann field theory with correlation functions (1.2) and we show that the Boltzmann field theory gives an analytical summation of half-planar diagrams.

We prove in pure algebraic way that the correlation functions (1.2) satisfy a closed set of Schwinger-Dyson-like equations. Moreover, starting with an arbitrary function of the interaction  $\Omega = \Omega(S_{int}(\phi))$  and using natural assumptions we show that the form (1.2) of  $\Omega(S_{int})$  is in fact an unique one which admits Schwinger-Dyson-like equations. We will call these equations the Boltzmannian Schwinger-Dyson equations.

We will see that there are an essential simplifications in the Boltzmannian Schwinger-Dyson equations. Namely, among the Boltzmannian Schwinger-Dyson equations for  $n$ -point Green's functions for  $n$  greater then the degree of  $S_{int}$  there are equations which relate  $n$ -point Green's functions only with  $k$ -point Green's functions for  $k \leq n$ . This is a distinguish feature of the Schwinger-Dyson equations for the Boltzmann fields and it drastically simplifies the situation. In particular in the case of quartic interaction one has a closed set of equations for two and four point correlation functions. Let us stress that this system of equations is exact one but not a truncation of the original system and it does not assume any approximation for correlation functions (1.2). The origin of this property of the Boltzmannian Schwinger-Dyson equations is related with a specific features of the Wick theorem for the free algebra (1.3). Note that in the operator form the Boltzmannian Schwinger-Dyson equations contain projectors on the vacuum state in the interaction terms.

The Boltzmannian system (1.2) can be considered as a non-trivial approximation to the planar correlation functions. Note in this context that in all previous attempts of approximated treatment of the planar theory some non-perturbative approximations were used [12, 13, 29]. Topologically diagrams representing the perturbative series of the Boltzmann correlation functions (1.2) look as rainbow (or half-planar) graphs of the usual diagram technique for matrix models [26]. This is a reason to call the Boltzmann correlation functions the half-planar correlation functions and the corresponding equations the half-planar Schwinger-Dyson equations. Comparing three sets of the Schwinger-Dyson equations, full, planar and half-planar ones, one can say that the operator form of the full Schwinger-Dyson equations is the simplest one. Indeed, the planar Schwinger-Dyson equations contain projectors in the Schwinger terms and the half-planar Schwinger-Dyson equations also contain projectors in the interactions terms. However just due to the presence of additional projectors it turns out that the half-planar Schwinger-Dyson equations admit analytical investigations.

We will find explicitly the correlation function (1.2) for the quartic interaction in the case of one degree of freedom. We compare numerically the two-, four- and six-point half-planar correlation functions with the corresponding planar correlation functions for the one matrix model. For large variety of the coupling constant the half-planar approximation reproduces the planar approximation with good accuracy. However the half-planar approximation does not reproduce asymptotics of correlation functions in the strong coupling regime. To reproduce the strong coupling regime one has to consider more large class of graphs [30].

For the case of finite number of degrees of freedom and a special action with a diagonal quadratic term it is also possible to get an analytical solutions of the Boltzmannian Schwinger-Dyson equations. For more complicated case of a non-diagonal quadratic action and quartic interaction the system of equations for two- and four-point correlations functions is reduced to an algebraic system of equations that admits a numerical solution. This system describes the half-planar approximation of the two-matrix model which has been analyzed recently by Douglas and Li [31] using the language of functions of non-commutating variables.

An analytical investigation of the correlation functions (1.2) is also possible for  $D$ -dimensional space-time. In the case of quartic interaction one has a closed set of integral equations for two- and four-point correlation functions. For four-point correlation functions we get a Bethe-Salpeter-like equation. A special approximation reduces this system

of integral equations to a linear integral equation which has been considered [32] in the rainbow approximation in the usual field theory.

For four-dimensional space-time the perturbative expansion of correlation functions (1.2) has ultraviolet divergences. To remove these divergencies we apply R-operation [33]. We show that an application of R-operation is equivalent to an introduction of counterterms to the interaction Lagrangian. As usual this fact permits to write down the renormalization group equations. Because of special features of the Boltzmann field theory the renormalization group equations are different from the ordinary renormalization group equations. There is also a difference in the explicit formula for the beta-function in terms of renormalization constants.

The paper is organized as follows. In Section 2 we deal with one degree of freedom, in Section 3 we consider finite number of degrees of freedom and the last section is devoted to continuous fields in  $D$  dimensions. We start Section 2 by reminding specific feature of free Fock space for one degree of freedom. In subsection 2.2 we show in pure algebraic way that the correlation functions (1.2) satisfy a closed set of Schwinger-Dyson-like equations. Then we study a question of uniqueness of the form (1.2) for  $\Omega$ . In 2.3 we present an operator form of the Boltzmannian Schwinger-Dyson equations. In 2.4 we solve explicitly these equations. In subsections 2.5, 2.6 and 2.7 we present a generating functional for correlation functions for different forms of interaction. In subsection 2.8 we compare the half-planar approximation with the exact answer for the sum of the planar diagrams for the one matrix model. In Section 3 we consider the same questions for finite number of degrees of freedom. The goal of Section 4 is to demonstrate that the infinite set of the Schwinger-Dyson equations for Boltzmann correlation functions (1.2) in  $D$ -dimensions allows a reduction to a finite system of integral equations for lower correlation functions. In subsection 4.2 we consider the quartic interaction and present a system of integral equations for two- and four-point correlation functions. In 4.3 we study the renormalization of the correlation functions (1.2) and derive the renormalization group equation for  $D = 4$ . In Appendix a calculation of combinatoric factors for planar correlation functions is presented.

## 2 One Degree of Freedom

### 2.1 Boltzmannian Fock Space and Free Correlation Functions

In this section we consider the free correlation functions in the Boltzmannian Fock space in zero-dimensional space-time. Let us start from the general definition of Boltzmannian Fock space, then we will restrict ourself to zero-dimensional case.

The free (or Boltzmannian) Fock space  $\mathcal{H}$  over the Hilbert space  $H$  is just the tensor algebra

$$\mathcal{H} = \bigoplus_{n=0}^{\infty} H^{\otimes n}.$$

Creation and annihilation operators are defined as

$$\begin{aligned} a^+(f)f_1 \otimes \dots \otimes f_n &= f \otimes f_1 \otimes \dots \otimes f_n \\ a(f)f_1 \otimes \dots \otimes f_n &= \langle f, f_1 \rangle \otimes f_2 \otimes \dots \otimes f_n \end{aligned} \quad (2.1)$$

where  $\langle f, g \rangle$  is the inner product in  $H$ . We have

$$a(f)a^+(g) = \langle f, g \rangle. \quad (2.2)$$

We shall consider the simplest case  $H = C$ . One has the vacuum vector  $|0\rangle$ ,

$$a|0\rangle = 0 \quad (2.3)$$

and  $n$ -particle states

$$|n\rangle = (a^+)^n|0\rangle. \quad (2.4)$$

The master field in zero-dimensional case is

$$\phi = a + a^+, \quad (2.5)$$

where  $a$  and  $a^+$  satisfy the following relation

$$aa^+ = 1. \quad (2.6)$$

This algebra has a realization in the free (or Boltzmannian) Fock space.

One can formulate the Boltzmannian Wick theorem which is an analog of the ordinary Wick theorem. For this purpose let us define the normal product of operators (2.5) in the following way

$$:\phi^n := \sum_{m=0}^n (a^+)^m a^{n-m}. \quad (2.7)$$

Note that (2.7) is different from the normal product of  $n$ -th power of ordinary field  $\varphi = \alpha + \alpha^+$

$$:\varphi^n := \sum_{m=0}^n \frac{n!}{(n-m)!m!} (\alpha^+)^m \alpha^{n-m},$$

where  $[\alpha, \alpha^+] = 1$ . For an arbitrary product of creation and annihilation operators we define the normal product as

$$\begin{aligned} &:(a^+)^{n_1}(a)^{m_1}(a^+)^{n_2}(a)^{m_2}\dots(a^+)^{n_l}(a)^{m_l} := \\ &\sum_{k=1}^l (a^+)^{N_k}(a)^{\hat{M}_k} \delta_{\hat{N}_k,0} \delta_{M_k,0}, \end{aligned} \quad (2.8)$$

where

$$N_k = \sum_{i=1}^k n_i, \quad \hat{N}_k = \sum_{i=k}^l n_i, \quad M_k = \sum_{i=1}^{k-1} m_i, \quad \hat{M}_k = \sum_{i=k+1}^l m_i$$

and

$$\delta_{n,0} = \begin{cases} 1, & n = 0, \\ 0, & n \neq 0. \end{cases}$$

Let us call a contraction of two operators an admissible one if it relates neighboring operators. The Boltzmannian Wick theorem states that the product of operators (2.8) is equal to the normal product of these operators plus sum of normal products of these operators with all admissible contractions. In particular,

$$:\phi^n :: \phi^m :=: \phi^{n+m} : + \sum_{k=1}^{\min(n,m)} : \phi^{n+m-2k} :. \quad (2.9)$$

A free  $n$ -point Green's function is defined as the vacuum expectation of  $n$ -th power of master field (2.5)

$$G_n^{(0)} = \langle 0|\phi^n|0\rangle. \quad (2.10)$$

As it is well-known, the Green's function (2.10) is given by a  $n$ -th moment of Wigner's distribution [34, 21]

$$G_n^{(0)} = \frac{1}{2\pi} \int_{-2}^2 \lambda^n \sqrt{4 - \lambda^2} d\lambda \quad (2.11)$$

and  $G_{2n}^{(0)} = c_n$ , where  $c_n$  are the Catalane numbers

$$c_n = \frac{(2n)!}{n!(n+1)!}. \quad (2.12)$$

In [36] an algebraic origin of the representation (2.11) has been found. It is related with the fact that the algebra (2.6) is isomorphic to the quantum semigroup  $SU_q(2)$  with  $q = 0$  and (2.11) is the Haar measure on  $SU_q(2)$ .

The representation (2.11) can be also obtained as a solution of the Schwinger-Dyson equations. To get these equations from definitions (2.6)-(2.10) let us calculate (2.10) using the Boltzmannian Wick theorem. We present the result of an application of the Wick theorem graphically (Fig. 1). We draw the  $n$ -th power of  $\phi$  as  $n$  points lying on a line and the contractions as upper half-ovals. According to the relation  $aa^+ = 1$  all points may be connected only by non-overlapping upper half-ovals. Considering all possible contractions of the first point from the left and taking into account that all odd correlation functions are equal to zero we have

$$G_{2n}^{(0)} = \sum_{m=1}^n G_{2m-2}^{(0)} G_{2n-2m}^{(0)}. \quad (2.13)$$

Equation (2.13) leads to an algebraic equation [26] for a generation functional

$$Z^{(0)}(j) = \sum_{n=0}^{\infty} G_n^{(0)} j^n, \quad G_0^{(0)} = 1. \quad (2.14)$$

Indeed, multiplying (2.13) by  $j^{2n}$  and making the summation over  $n$  we have

$$\sum_{n=1}^{\infty} G_{2n}^{(0)} j^{2n} = \sum_{n=1}^{\infty} \sum_{m=1}^n G_{2m-2}^{(0)} G_{2n-2m}^{(0)} j^{2n}.$$

Using

$$\sum_{n=1}^{\infty} \sum_{m=1}^n f(n, m) = \sum_{m=1}^{\infty} \sum_{n=m}^{\infty} f(n, m)$$

and making the change  $m - 1 \rightarrow m$ ,  $n - m \rightarrow n$ , we get the equation

$$\sum_{n=1}^{\infty} G_{2n}^{(0)} j^{2n} = \sum_{m=0}^{\infty} \sum_{n=0}^{\infty} G_{2m}^{(0)} G_{2n}^{(0)} j^{2n+2m+2},$$

which in terms of generation functional can be written in the form

$$Z^{(0)}(j) - 1 = j^2 [Z^{(0)}(j)]^2. \quad (2.15)$$

Under the initial condition  $Z^{(0)}(0) = 1$  the solution of equation (2.15) is

$$Z^{(0)}(j) = \frac{1 - \sqrt{1 - 4j^2}}{2j^2} = \sum_{n=0}^{\infty} \frac{(2n)!}{n!(n+1)!} j^{2n}. \quad (2.16)$$

One has the integral representation for  $Z^{(0)}(j)$

$$Z^{(0)}(j) = \frac{1}{2\pi} \int_{-2}^2 \frac{1}{1 - \lambda j} \sqrt{4 - \lambda^2} d\lambda, \quad (2.17)$$

that is in agreement with (2.11).

Note that in the above formulae  $j$  may be considered as an operator. If one assumes that  $j$  satisfies a non-standard differentiation rule

$$\frac{d}{dj} j^n = j^{n-1}, \quad (2.18)$$

then one can deduce the following differential equation for  $Z(j)$  [7]:

$$\frac{d^2}{dj^2} Z^{(0)}(j) = [Z^{(0)}(j)]^2. \quad (2.19)$$

To reproduce (2.16) one has to assume the following initial conditions

$$Z^{(0)}(0) = 1, \quad \left(\frac{d}{dj} Z^{(0)}\right)(0) = 0. \quad (2.20)$$

In what follows we shall also use the following modified form of equations (2.13)

$$G_{2n}^{(0)} = \sum_{m=0}^{k-1} G_{2k-2m-2}^{(0)} G_{2n+2m-2k}^{(0)} + \sum_{m=k}^{n-1} G_{2m-2k}^{(0)} G_{2n+2k-2m-2}^{(0)} \quad (2.21)$$

for any  $k = 1, 2, \dots, n$ . Equations (2.21) are obtained by a simple change of summation index. Indeed, making the change  $m \rightarrow m' = k - m$  in the first sum of (2.21), we get

$$\sum_{m'=1}^k G_{2m'-2}^{(0)} G_{2n-2m'}^{(0)}.$$

Introducing the new summation index in the second term in right hand side of (2.21) as  $m' = n + k - m$  we get

$$\sum_{m'=k+1}^n G_{2n-2m'}^{(0)} G_{2m'-2}^{(0)},$$

so, (2.21) is equivalent to (2.13). Equations (2.21) are the Schwinger-Dyson equations written for the case when one traces down for contractions of  $2k$ -th operator in the vacuum expectation  $\langle \phi \phi \dots \phi \rangle$ . This is illustrated on Fig. 2. The same equations are obtained when one traces down for the contraction of  $2k + 1$ -th operator (Fig. 3).

Equations (2.21) are 0-dimensional analogues of the  $D$ -dimensional Schwinger-Dyson equations written for the case when the operators  $(-\Delta_{x_{2k}} + m^2)$  or  $(-\Delta_{x_{2k+1}} + m^2)$  are applied to a Green's function  $G_{2n}^{(0)}(x_1, \dots, x_n)$ .

## 2.2 Boltzmannian Schwinger-Dyson Equations

In the ordinary Euclidean formulation of Bose or Fermi 0-dimensional quantum field theory the interacting Green's functions have the form

$$G_n^{(\text{Eucl.})} = \langle 0 | \varphi^n e^{-S_{\text{int}}(\varphi)} | 0 \rangle, \quad (2.22)$$

A natural generalization of this formula to the case of Boltzmann statistic is

$$\mathcal{G}_n = \langle 0 | \phi^n \Omega(S_{int}(\phi)) | 0 \rangle, \quad (2.23)$$

where  $\Omega(S_{int}(\phi))$  is not necessary an exponent but some analytical function of the Lagrangian. First of all we will consider the function  $\Omega(S_{int}(\phi))$  of special form [26]

$$\Omega(S_{int}) = \frac{1}{1 + S_{int}} \quad (2.24)$$

and we will derive the Schwinger-Dyson-like equation for interacting Green's functions (2.23). Then under some natural assumptions discussed below we will prove that the form (2.24) is unique.

We will consider the case of quartic interaction  $S_{int} = g\phi^4$ . The generalization for an arbitrary polynomial interaction is straightforward.

Using the Taylor expansion for  $\Omega(g\phi^4)$

$$\Omega(g\phi^4) = \sum_{m=0}^{\infty} g^m \Omega_m \phi^{4m}, \quad (2.25)$$

where  $\Omega_m = (-1)^m$  for (2.24), we write the Green's functions  $\mathcal{G}_n$  in terms of the free Green's functions  $\mathcal{G}_n^{(0)}$ :

$$\mathcal{G}_n = \sum_{m=0}^{\infty} g^m \Omega_m \langle 0 | \phi^{n+4m} | 0 \rangle = \sum_{m=0}^{\infty} g^m \Omega_m \mathcal{G}_{n+4m}^{(0)}. \quad (2.26)$$

Using the free Schwinger-Dyson equations in the form

$$\mathcal{G}_n^{(0)} = \sum_{l=1}^{k-1} \mathcal{G}_{k-l-1}^{(0)} \mathcal{G}_{n+l-k-1}^{(0)} + \sum_{l=k+1}^n \mathcal{G}_{l-k-1}^{(0)} \mathcal{G}_{n+k-l-1}^{(0)}, \quad k = 1, \dots, n, \quad (2.27)$$

(that coincides with (2.21) after setting  $\mathcal{G}_n = 0$  for odd  $n$ ) we get

$$\mathcal{G}_n = \sum_{m=0}^{\infty} g^m \Omega_m \left[ \sum_{l=1}^{k-1} \mathcal{G}_{k-l-1}^{(0)} \mathcal{G}_{l+n+4m-k-1}^{(0)} + \sum_{l=k+1}^{n+4m} \mathcal{G}_{l-k-1}^{(0)} \mathcal{G}_{n+4m+k-l-1}^{(0)} \right]. \quad (2.28)$$

Writing the sum in the second term of (2.28) as

$$\sum_{l=k+1}^{n+4m} = \sum_{l=k+1}^n + \sum_{l=n+1}^{n+4m} \quad (2.29)$$

and making the change of the summation index  $l - n \rightarrow l$  in the second sum of (2.29), one obtains

$$\begin{aligned} \mathcal{G}_n &= \sum_{l=1}^{k-1} \mathcal{G}_{k-l-1}^{(0)} \mathcal{G}_{l+n-k-1}^{(0)} + \sum_{l=k+1}^n \mathcal{G}_{l-k-1}^{(0)} \mathcal{G}_{n+k-l-1}^{(0)} + \\ &\sum_{m=0}^{\infty} g^m \Omega_m \sum_{l=1}^{4m} \mathcal{G}_{n+l-k-1}^{(0)} \mathcal{G}_{4m+k-l-1}^{(0)} = J_I + J_{II} + J_{III}. \end{aligned} \quad (2.30)$$



Using the formulas

$$\begin{aligned} \sum_{l=1}^{4m} f(l) &= \sum_{p=0}^{m-1} [f(4p+1) + f(4p+2) + f(4p+3) + f(4p+4)], \\ \sum_{m=0}^{\infty} \sum_{p=0}^{m-1} f(m,p) &= \sum_{p=0}^{\infty} \sum_{m=p+1}^{\infty} f(m,p) \end{aligned} \quad (2.31)$$

and making the change  $m \rightarrow m + p + 1$  in the second line of (2.31) one can rewrite  $J_{III}$  in the following way

$$\begin{aligned} J_{III} &= \sum_{p=0}^{\infty} \sum_{m=0}^{\infty} g^{m+p+1} \Omega_{m+p+1} [\mathcal{G}_{n-k+4p}^{(0)} \mathcal{G}_{4m+k+2}^{(0)} + \mathcal{G}_{n-k+4p+1}^{(0)} \mathcal{G}_{4m+k+1}^{(0)} + \\ &\quad + \mathcal{G}_{n-k+4p+2}^{(0)} \mathcal{G}_{4m+k}^{(0)} + \mathcal{G}_{n-k+4p+3}^{(0)} \mathcal{G}_{4m+k-1}^{(0)}], \end{aligned} \quad (2.32)$$

so equation (2.30) takes the form

$$\begin{aligned} \mathcal{G}_n &= \sum_{l=1}^{k-1} \mathcal{G}_{k-l-1}^{(0)} \mathcal{G}_{l+n-k-1} + \sum_{l=k+1}^n \mathcal{G}_{l-k-1}^{(0)} \mathcal{G}_{n+k-l-1} + \\ &\quad \sum_{p=0}^{\infty} \sum_{m=0}^{\infty} g^{m+p+1} \Omega_{m+p+1} [\mathcal{G}_{n-k+4p}^{(0)} \mathcal{G}_{4m+k+2}^{(0)} + \mathcal{G}_{n-k+4p+1}^{(0)} \mathcal{G}_{4m+k+1}^{(0)} + \\ &\quad \mathcal{G}_{n-k+4p+2}^{(0)} \mathcal{G}_{4m+k}^{(0)} + \mathcal{G}_{n-k+4p+3}^{(0)} \mathcal{G}_{4m+k-1}^{(0)}]. \end{aligned} \quad (2.33)$$

Note that two first sums in (2.33) are nothing but Schwinger's terms. Since the coefficients  $\Omega_m$  satisfy the relations

$$\Omega_{n+m} = \Omega_n \Omega_m, \quad (2.34)$$

we have a possibility to represent the third sum as a combination of interacting Green's functions (2.23). With  $\Omega$  in the form (2.24) equations (2.33) take the form

$$\begin{aligned} \mathcal{G}_n &= -g[\mathcal{G}_{n-k} \mathcal{G}_{k+2} + \mathcal{G}_{n-k+1} \mathcal{G}_{k+1} + \mathcal{G}_{n-k+2} \mathcal{G}_k + \mathcal{G}_{n-k+3} \mathcal{G}_{k-1}] + \\ &\quad \sum_{l=1}^{k-1} \mathcal{G}_{k-l-1}^{(0)} \mathcal{G}_{l+n-k-1} + \sum_{l=k+1}^n \mathcal{G}_{l-k-1}^{(0)} \mathcal{G}_{n+k-l-1}. \end{aligned} \quad (2.35)$$

Equations (2.35) are the Schwinger-Dyson-like equations for zero-dimensional Boltzmann theory with quartic interaction. We will also call these equations the Boltzmannian Schwinger-Dyson equations.

We see that the terms describing an interaction are quadratic on the correlations functions. The sum of indices in all these terms is constant and depends on the power of the interaction. One can prove that under the assumption of such structure for the interaction terms in the Schwinger-Dyson-like equations the form of  $\Omega$  is unique. In fact, one assumes that the form of  $\Omega$  does not depend on the special choice of the interaction and  $\Omega(0) = 1$ . These assumptions mean that in particular for the linear interaction  $S_{int} = g\phi$  one has the following Schwinger-Dyson-like equations

$$\mathcal{G}_n = -g\mathcal{G}_{n-1}\mathcal{G}_0 + \text{Schwinger's terms}, \quad n > 0. \quad (2.36)$$

Let us derive that the form (2.24) follows from (2.36). Expanding the both sides of (2.36) on power coupling we have

$$\sum_{m=0}^{\infty} g^m \Omega_m \mathcal{G}_{n+m}^{(0)} = -g \sum_{m=0}^{\infty} g^m \Omega_m \mathcal{G}_{n-1+m}^{(0)} \cdot \sum_{k=0}^{\infty} g^k \Omega_k \mathcal{G}_k^{(0)} + \text{Schwinger's terms}, \quad (2.37)$$

Using equation (2.27) and comparing the coefficients in front of the same powers of the coupling constant we obtain

$$\sum_{k=0}^m (\Omega_k \Omega_{m-k} + \Omega_{m+1}) \mathcal{G}_{n+k}^{(0)} \mathcal{G}_{m-k}^{(0)} = 0 \quad (2.38)$$

For  $m = 0$  from (2.38) we have  $\Omega_0^2 + \Omega_1 = 0$  and taking into account  $\Omega_0 = 1$  we get  $\Omega_1 = -1$ . Assuming

$$\Omega_m = (-1)^m \quad (2.39)$$

for  $m < m_0$  and using equation (2.38) one can prove that this relation is also hold for  $m = m_0$ , that gives by induction the prove of (2.39).

From the above consideration we see that to get a closed set of Schwinger-Dyson equations in the free Fock space for an interacting case one has to deal with a non-Heisenberg dynamics and the Green's function in the interaction representation are not represented as exponential function of the interaction but are given by formula (2.24).

## 2.3 An Operator Form of the Boltzmannian Schwinger-Dyson Equations

Let us write down the weak operator form of equation (2.35). By the weak operator form we mean the relation that is hold after averaging with the function (2.24). Let first consider the case  $k = n$ . Then equations (2.35) take the form

$$\mathcal{G}_n = -g[\mathcal{G}_0 \mathcal{G}_{n+2} + \mathcal{G}_2 \mathcal{G}_n] + \sum_{l=0}^{n-2} \mathcal{G}_l^{(0)} \mathcal{G}_{n-l-2}, \quad n > 1. \quad (2.40)$$

The left hand side of (2.40) represents the term  $\phi \phi^{n-1}$ . The last term in the right hand side of (2.40) is the Schwinger term and it can be represented by the following commutator

$$-i[\pi, \phi^{n-1}], \quad (2.41)$$

where  $\pi$  is an element of the following algebra [5, 17]

$$[\pi, \phi] = i|0 \rangle \langle 0|. \quad (2.42)$$

Indeed, after performing the average of (2.41) with  $\Omega$  we get

$$-i \langle 0 | [\pi, \phi^{n-1}] \Omega | 0 \rangle = \sum_{l=0}^{n-2} \mathcal{G}_l^{(0)} \mathcal{G}_{n-l-2} \quad (2.43)$$

The sum in the square brackets in (2.40) can be represented as an average of the product of  $\phi^{n-1}$  with the following sum of operators

$$\phi^3 |\Omega \rangle \langle 0| + \phi^2 |\Omega \rangle \langle 0| \phi + \phi |\Omega \rangle \langle 0| \phi^2 + |\Omega \rangle \langle 0| \phi^3. \quad (2.44)$$

Note that these terms can be represented as

$$\begin{aligned} \mathcal{V}_{int} = & \frac{\delta S_{int}[\phi]}{\delta \phi} |\Omega\rangle \langle 0| + \frac{\delta^2 S_{int}[\phi]}{\delta \phi^2} |\Omega\rangle \langle 0| \phi + \dots + \\ & \phi |\Omega\rangle \langle 0| \frac{\delta^2 S_{int}[\phi]}{\delta \phi^2} + |\Omega\rangle \langle 0| \frac{\delta S_{int}[\phi]}{\delta \phi} \end{aligned} \quad (2.45)$$

if one assumes that non-commutative derivatives

$$\frac{\delta \phi^n}{\delta \phi} = \phi^{n-1}. \quad (2.46)$$

are implied in (2.45). Therefore, equations (2.40) is the equation for the average

$$\langle 0 | \mathcal{E} \phi^{n-1} | \Omega \rangle = 0, \quad (2.47)$$

where the operator  $\mathcal{E}$  can be represented as

$$\mathcal{E} = \frac{\delta S_0[\phi]}{\delta \phi(x)} + \mathcal{V}_{int} + \mathcal{S} \quad (2.48)$$

with

$$\mathcal{S} = [\pi, \cdot]. \quad (2.49)$$

For  $k < n$  equations (2.35) can be also represented as the average

$$\langle 0 | \phi^k \mathcal{E} \phi^{n-k-1} | \Omega \rangle = 0, \quad (2.50)$$

where one has to use another form for  $\mathcal{S}$ .

## 2.4 Solution of the Boltzmannian Schwinger-Dyson Equations

The distinguish feature of equations (2.35) is that for  $n \geq 4$  and  $2 \leq k \leq n - 1$  the right hand side of (2.35) does not contain the Green's functions  $\mathcal{G}_m$  with  $m > n$ . This fact permit us to write down a closed system of equations for any  $\mathcal{G}_n$ ,  $n \geq 4$ . Let us study this questions in more details.

Equations (2.35) for  $k = 1$  and  $k = 2$  take the form

$$\mathcal{G}_{2n} = \sum_{l=1}^n \mathcal{G}_{2l-2}^{(0)} \mathcal{G}_{2n-2l} - g \mathcal{G}_{2n} \mathcal{G}_2 - g \mathcal{G}_{2n+2} \mathcal{G}_0, \quad (2.51)$$

$$\mathcal{G}_{2n} = \sum_{l=1}^{n-1} \mathcal{G}_{2l-2}^{(0)} \mathcal{G}_{2n-2l} + \mathcal{G}_{2n-2} - g \mathcal{G}_{2n-2} \mathcal{G}_4 - g \mathcal{G}_{2n} \mathcal{G}_2, \quad (2.52)$$

where we use the fact that  $\mathcal{G}_{2n+1} = 0$ . Setting  $n = 1$  in (2.51) and  $n = 2$  in (2.52) we obtain the system of two equations for three unknown functions  $\mathcal{G}_0(g)$ ,  $\mathcal{G}_2(g)$  and  $\mathcal{G}_4(g)$ :

$$\begin{aligned} \mathcal{G}_2 &= \mathcal{G}_0 - g \mathcal{G}_2 \mathcal{G}_2 - g \mathcal{G}_4 \mathcal{G}_0, \\ \mathcal{G}_4 &= 2\mathcal{G}_2 - 2g \mathcal{G}_2 \mathcal{G}_4. \end{aligned} \quad (2.53)$$

To have the third equation let us note that there is an additional set of equations for Green's functions

$$\mathcal{G}_{2n} = \mathcal{G}_{2n}^{(0)} - g\mathcal{G}_{2n+4}, \quad (2.54)$$

that follow from the identity

$$\langle 0 | \frac{\phi^{2n}}{1 + g\phi^4} | 0 \rangle = \langle 0 | \phi^{2n} - \frac{g\phi^{2n+4}}{1 + g\phi^4} | 0 \rangle. \quad (2.55)$$

For the vacuum Green's function  $\mathcal{G}_0$  equation (2.54) has the form

$$\mathcal{G}_0 = 1 - g\mathcal{G}_4. \quad (2.56)$$

The system of equations (2.53) and (2.56) lead to the following equation for  $\mathcal{G}_0$

$$4g\mathcal{G}_0^4 + \mathcal{G}_0^2 - 1 = 0. \quad (2.57)$$

Taking into account the condition  $\mathcal{G}_0 = 1$  for  $g = 0$  we have

$$\mathcal{G}_0 = \sqrt{\frac{-1 + \sqrt{1 + 16g}}{8g}}. \quad (2.58)$$

The Green's functions  $\mathcal{G}_2$  and  $\mathcal{G}_4$  can be expressed in terms of  $\mathcal{G}_0$ :

$$\mathcal{G}_2 = \frac{1 - \mathcal{G}_0}{2g\mathcal{G}_0}, \quad \mathcal{G}_4 = \frac{1 - \mathcal{G}_0}{g}. \quad (2.59)$$

High-point Green's functions can be found from (2.54) after taking into account (2.58) and (2.59).

## 2.5 Generating Functional

A generating functional for interacting Green's functions is

$$Z(j, g) = \sum_{n=0}^{\infty} \mathcal{G}_{2n}(g) j^{2n}. \quad (2.60)$$

From (2.11) one has the following integral representation for  $Z(j, g)$

$$Z(j, g) = \frac{1}{2\pi} \int_{-2}^2 \frac{1}{1 - \lambda j} \frac{1}{1 + g\lambda^4} \sqrt{4 - \lambda^2} d\lambda \quad (2.61)$$

and the integral (2.61) can be calculated explicitly. However it is instructive to get an explicit derivation of  $Z(j, g)$  in a pure algebraic way, since just this method can be generalized to the  $D$ -dimensional space-time.

From (2.51) it follows

$$j^2[Z(j) - \mathcal{G}_0] = j^4 Z^{(0)}(j) Z(j) - gj^2 \mathcal{G}_2 [Z(j) - \mathcal{G}_0] - g[Z(j) - \mathcal{G}_2 j^2 - \mathcal{G}_0] \mathcal{G}_0 \quad (2.62)$$

and

$$Z(j) = \frac{j^2 \mathcal{G}_0 (1 + 2g\mathcal{G}_2) + g\mathcal{G}_0^2}{g\mathcal{G}_0 + j^2(1 + g\mathcal{G}_2) - j^4 Z^{(0)}(j)} =$$

$$\frac{2\mathcal{G}_0(j^2 + g\mathcal{G}_0^2)}{2g\mathcal{G}_0^2 + j^2(1 + \mathcal{G}_0) - 2j^4\mathcal{G}_0Z^{(0)}(j)}. \quad (2.63)$$

Using (2.54) one can write the equation for  $Z(j)$  in an alternative form

$$j^4Z(j) = j^4Z^{(0)}(j) - g[Z(j) - \mathcal{G}_2j^2 - \mathcal{G}_0], \quad (2.64)$$

and therefore

$$\begin{aligned} Z(j) &= \frac{j^4Z^{(0)}(j) + g\mathcal{G}_2j^2 + g\mathcal{G}_0}{j^4 + g} = \\ &= \frac{2g\mathcal{G}_0Z^{(0)}(j) + gj^2 - g\mathcal{G}_0j^2 + 2g^2\mathcal{G}_0^2}{2g\mathcal{G}_0(j^4 + g)}. \end{aligned} \quad (2.65)$$

Taking into account (2.15) and (2.57) one can verify that (2.65) coincides with (2.63).

## 2.6 Correlation Functions without Vacuum Insertions

To calculate the Green's functions without vacuum insertions  $G_n$  note that they satisfy the same Schwinger-Dyson equations, but one has to use another "initial" condition, namely  $G_0 = 1$ . The system of equations for 2-, 4-, and 6-point Green's functions is

$$\begin{aligned} G_2 &= 1 - gG_2G_2 - gG_4, \\ G_4 &= 2G_2 - 2gG_2G_4, \\ G_6 &= G_2 + 2G_4 - gG_4^2 - gG_2G_6. \end{aligned} \quad (2.66)$$

From the first two lines of (2.66) one gets the following equation for  $G_2$ :

$$2g^2G_2^3 + 3gG_2^2 + G_2 - 1 = 0. \quad (2.67)$$

Introducing a new variable  $\tilde{G}_2$ ,

$$G_2 = \frac{\tilde{G}_2 - 1}{2g}, \quad (2.68)$$

we have

$$\tilde{G}_2^3 - \tilde{G}_2 - 4g = 0. \quad (2.69)$$

The solution of equations (2.69) has a different form in dependence on values of  $g$ .

Using the Cardano formula we have

$$\tilde{G}_2 = \frac{2}{\sqrt{3}} \operatorname{Re} e^{i\frac{\pi}{6}} (\sqrt{1 - 108g^2} - i6\sqrt{3}g)^{\frac{1}{3}} \quad (2.70)$$

for  $g \leq \frac{\sqrt{3}}{18}$  and

$$\tilde{G}_2 = \frac{1}{\sqrt{3}} [(6\sqrt{3}g + \sqrt{108g^2 - 1})^{\frac{1}{3}} + (6\sqrt{3}g - \sqrt{108g^2 - 1})^{\frac{1}{3}}] \quad (2.71)$$

for  $g \geq \frac{\sqrt{3}}{18}$ . Therefore

$$G_2 = \frac{1}{2g} \left[ \frac{2}{\sqrt{3}} \operatorname{Re} e^{i\frac{\pi}{6}} (\sqrt{1 - 108g^2} - i6\sqrt{3}g)^{\frac{1}{3}} - 1 \right] =$$

$$1 - 3g + 16g^2 - 105g^3 + 768g^4 \dots \quad (2.72)$$

for  $g \leq \frac{\sqrt{3}}{18}$  and

$$G_2 = \frac{1}{2\sqrt{3}g} [(6\sqrt{3}g + \sqrt{108g^2 - 1})^{\frac{1}{3}} + (6\sqrt{3}g - \sqrt{108g^2 - 1})^{\frac{1}{3}} - \sqrt{3}] \quad (2.73)$$

for  $g \geq \frac{\sqrt{3}}{18}$ .

An equation for a generating functional for Green's functions without vacuum insertions  $\mathcal{Z}(j)$  follows from (2.62) by setting  $G_0 = 1$ :

$$j^2[\mathcal{Z}(j) - 1] = j^4 Z^{(0)}(j)\mathcal{Z}(j) - gj^2 G_2[\mathcal{Z}(j) - 1] - g[\mathcal{Z}(j) - G_2 j^2 - 1]. \quad (2.74)$$

From (2.74) we find

$$\mathcal{Z}(j) = \frac{g + j^2(2gG_2 + 1)}{g + j^2(gG_2 + 1) - j^4 Z^{(0)}(j)}, \quad (2.75)$$

where  $Z^{(0)}(j)$  and  $G_2$  are given by (2.16) and (2.72), (2.73), respectively.

The generating functionals  $Z(j, g)$  and  $\mathcal{Z}(j, g)$  are related by the formula

$$Z(j, g) = G_0(g)\mathcal{Z}(j, gG_0(g)), \quad (2.76)$$

which follows from the relation

$$G_n(g) = G_0(g)G_n(gG_0(g)). \quad (2.77)$$

The last relation is true due to the Boltzmannian Wick theorem. It is easy to check that  $Z(j, g)$  and  $\mathcal{Z}(j, g)$  given by (2.63) and (2.75) satisfy the relation (2.76). Indeed, from (2.75) it follows that

$$G_0(g)\mathcal{Z}(j, gG_0(g)) = \frac{gG_0^2 + j^2(1 + 2gG_0G_2(gG_0))}{gG_0 + j^2(1 + gG_0G_2(gG_0) - j^4 Z^{(0)}(j))}.$$

Replacing in the right hand side of this relation  $G_0G_2(gG_0)$  by  $G_2$  and taking into account (2.62) we get the expression for  $Z(j, g)$ .

## 2.7 Correlation Functions for Normal Ordered Interaction

In this subsection we will consider the Boltzmann theory with a normal ordered interaction  $:\phi^4:$ . Let us denote by  $\bar{G}_n$  the  $n$ -point Green's function without vacuum insertions in such theory. According to the definition of Boltzmannian normal product we have

$$:\phi^4 := \phi^4 - 3\phi^2 - 2 \quad (2.78)$$

and so

$$\bar{G}_{2n} = \langle 0 | \phi^{2n} \frac{1}{1 + g(\phi^4 - 3\phi^2 - 2)} | 0 \rangle. \quad (2.79)$$

Let us write down the Schwinger-Dyson equations for Green's functions  $\bar{G}_n$ . Repeating all steps as for derivation of (2.51) and (2.52) we get

$$\bar{G}_{2n} = \sum_{l=1}^n \bar{G}_{2l-2}^{(0)} \bar{G}_{2n-2l} - g \bar{G}_{2n} \bar{G}_2 - g \bar{G}_{2n+2} \bar{G}_0 + 3g \bar{G}_{2n}, \quad (2.80)$$

$$\bar{G}_{2n} = \sum_{l=1}^{n-1} \bar{G}_{2l-2}^{(0)} \bar{G}_{2n-2l} + \bar{G}_{2n-2} - g\bar{G}_{2n-2}\bar{G}_4 - g\bar{G}_{2n}\bar{G}_2 + 3g\bar{G}_{2n-2}\bar{G}_2. \quad (2.81)$$

Putting  $n = 1$  in (2.80),  $n = 2$  and  $n = 3$  in (2.81) we obtain the following equations for  $\bar{G}_2$ ,  $\bar{G}_4$  and  $\bar{G}_6$

$$\begin{aligned} \bar{G}_2 &= 1 - g\bar{G}_2\bar{G}_2 - g\bar{G}_4 + 3g\bar{G}_2, \\ \bar{G}_4 &= 2\bar{G}_2 - 2g\bar{G}_2\bar{G}_4 + 3g\bar{G}_2\bar{G}_2, \\ \bar{G}_6 &= \bar{G}_2 + 2\bar{G}_4 - g\bar{G}_4^2 - g\bar{G}_2\bar{G}_6 + 3g\bar{G}_2\bar{G}_4. \end{aligned} \quad (2.82)$$

From the first two lines of (2.82) one can derive the equation for  $\bar{G}_2$

$$2g^2\bar{G}_2^3 + 3g(1-g)\bar{G}_2^2 + (1-3g)\bar{G}_2 - 1 = 0. \quad (2.83)$$

We restrict ourself by writing the perturbative solution of (2.83) up to order  $g^4$ :

$$\bar{G}_2 = 1 + g^2 - 3g^3 + 9g^4 + \dots. \quad (2.84)$$

## 2.8 The Half-Planar Approximation and the Two-Field Boltzmann Theory

In the previous subsections we have investigated the interacting Boltzmann theory itself. In this subsection we are going to compare the Boltzmann theory and the planar approximation for the one-matrix model. Green's functions for the one-matrix model in the planar approximation are defined as

$$\begin{aligned} \Pi_{2n}(g) &= \lim_{N \rightarrow \infty} \frac{1}{N^{1+n}} \frac{1}{\mathcal{Z}} \int dM \operatorname{tr} (M^{2n}) \exp\left[-\frac{1}{2} \operatorname{tr} (M^2) - \frac{g}{4N} \operatorname{tr} (M^4)\right], \\ \mathcal{Z} &= \int DM \exp\left[-\frac{1}{2} \operatorname{tr} (M^2) - \frac{g}{4N} \operatorname{tr} (M^4)\right], \end{aligned} \quad (2.85)$$

The integration in (2.85) is over  $N \times N$  hermitian matrices. According the 't Hooft diagram technique the perturbative expansion in the coupling constant of the correlation functions (2.85) is given by a sum of all planar double-line graphs [1]. Due to a normalization factor  $N^{-(1+n)}$  external lines corresponding to  $\operatorname{tr} M^{2n}$  can be treated as lines of a generalized vertex. Note that all vertices of these graphs have the equal orientation (left or right in dependence on an adopted convention). We shall call two double-line planar graphs topologically equivalent if one of them can be transformed into the other by a continuous deformation on the plane.

A planar non-vacuum graph is an half-planar graph if it can be drawn so that all its vertices lie on some plane line in the right of the generalized vertex  $\operatorname{tr} M^{2n}$  and all propagators lie in the upper-half plane without overlapping [26]. Also we shall call a planar graph the half-planar irreducible graph if it can be represented as an half-planar graph in an unique way. A simple analysis shows that an half-planar graph is the half-planar-irreducible one if it does not contain any tadpole subgraphs. By a graph with a tadpole, as usual, we mean a graph with a subgraph which contains two lines coming from the same vertex so that after removing of these two lines the remaining subgraph becomes disconnected with the rest of the graph.

In [26] it has been shown that if one considers some special approximation for the planar theory, namely so called half-planar approximation, then Green's functions of the

one-matrix model in this approximation coincide with correlation functions in a corresponding Boltzmann theory,

$$\Pi_{2n}^{HP}(g) = \langle \phi^{2n} (1 + g\phi^4)^{-1} \rangle. \quad (2.86)$$

In both hand sides of (2.86) we omit all graphs with tadpoles. The reason to omit the graphs with tadpoles is that otherwise we have a double-counting for graphs with tadpoles for the Boltzmann theory. We call this approximation the half-planar approximation.

A pure combinatorial proof of equation (2.86) is based on the following two statements. The first one states that the planar correlation functions without vacuum insertions in all order of perturbation theory are represented by a sum of all topologically non-equivalent graphs without any combinatoric factors. The proof of this statement is presented in Appendix B. According the second one in the Boltzmann theory all graphs contribute into correlations functions without any combinatoric factors.

Let us compare the half-planar approximation with the planar approximation in first orders of perturbative expansion in the coupling constant. We collect corresponding diagrams on Figures 5-7.

The explicit formula for an arbitrary planar Green's function without vacuum insertions is [34, 35]

$$\Pi_{2n}(g) = \frac{(2n)!}{n!(n+2)!} a^{2n} (2n+2 - na^2), \quad (2.87)$$

where

$$a^2 = \frac{1}{6g} [\sqrt{1+12g} - 1]. \quad (2.88)$$

For  $n = 1, 2, 3$  we have

$$\begin{aligned} \Pi_2 &= \frac{1}{3} a^2 (4 - a^2) = 1 - 2g + 9g^2 - 54g^3 + 378g^4 - \dots, \\ \Pi_4 &= a^4 (3 - a^2) = 2 - 9g + 54g^2 - 378g^3 + 2920g^4 - \dots, \\ \Pi_6 &= a^6 (8 - 3a^2) = 5 - 36g + 270g^2 - 2164g^3 + \dots. \end{aligned} \quad (2.89)$$

On Table 1 the results of numerical calculations of half-planar Green's functions  $\mathcal{G}_2, \mathcal{G}_4, \mathcal{G}_6$  and the planar Green's function  $\Pi_2, \Pi_4, \Pi_6$  for some values of the coupling constant  $g$  are presented

Table 1

$g$	$10^{-3}$	$10^{-2}$	$10^{-1}$	1	10	$10^2$	$10^3$
$\Pi_2$	$9.98 \cdot 10^{-1}$	$9.81 \cdot 10^{-1}$	$8.6 \cdot 10^{-1}$	$5.2 \cdot 10^{-1}$	$2.1 \cdot 10^{-1}$	$7.4 \cdot 10^{-2}$	$2.4 \cdot 10^{-2}$
$\mathcal{G}_2$	$9.97 \cdot 10^{-1}$	$9.71 \cdot 10^{-1}$	$8.0 \cdot 10^{-1}$	$4.0 \cdot 10^{-1}$	$1.3 \cdot 10^{-1}$	$3.2 \cdot 10^{-2}$	$7.4 \cdot 10^{-3}$
$\Pi_4$	1.99	1.96	1.42	$4.84 \cdot 10^{-1}$	$7.87 \cdot 10^{-2}$	$9.26 \cdot 10^{-3}$	$9.76 \cdot 10^{-4}$
$\mathcal{G}_4$	1.99	1.91	1.38	$4.43 \cdot 10^{-1}$	$7.16 \cdot 10^{-2}$	$8.65 \cdot 10^{-3}$	$9.37 \cdot 10^{-4}$
$\Pi_6$	4.96	4.67	2.92	$5.48 \cdot 10^{-1}$	$3.47 \cdot 10^{-2}$	$1.38 \cdot 10^{-3}$	$4.70 \cdot 10^{-5}$
$\mathcal{G}_6$	4.97	4.70	3.11	$7.78 \cdot 10^{-1}$	$9.64 \cdot 10^{-2}$	$1.00 \cdot 10^{-2}$	$1.00 \cdot 10^{-3}$

One can see that the answers for half-plane Green's functions  $\mathcal{G}_2, \mathcal{G}_4$  practically saturate the planar Green's functions  $\Pi_2, \Pi_4$  in board interval of the values of  $g$ .  $\mathcal{G}_6$  is in the good accordance with  $\Pi_6$  for  $g$  only for small  $g$ .



Let us make also a comparison of these two theories for the case when all tadpole graphs are neglected. The matrix theory the rejection of tadpole graphs is equivalent to adding to the Lagrangian the term

$$-g\tilde{\Pi}_2 \text{tr}(M^2), \quad (2.90)$$

where  $\tilde{\Pi}_2$  is tadpole-free two-point planar Green's function. So the tadpole-free planar Green's functions are defined as

$$\tilde{\Pi}_{2n} = \lim_{N \rightarrow \infty} \frac{1}{N^{1+n}} \int DM \text{tr}(M^{2n}) \exp\left[-\frac{1}{2}(1-2g\tilde{\Pi}_2)\text{tr}(M^2) - \frac{g}{4N}\text{tr}(M^4)\right]. \quad (2.91)$$

The perturbative expansion in the theory (2.91) is valid only for

$$1 - 2g\tilde{\Pi}_2 > 0. \quad (2.92)$$

For this case making the change of variable

$$M = (1 - 2g\tilde{\Pi}_2)^{-\frac{1}{2}} \tilde{M}$$

in the (2.91) one gets

$$\tilde{\Pi}_{2n} = \int D\tilde{M} (1 - 2g\tilde{\Pi}_2)^{-n} \text{tr}(\tilde{M}^{2n}) \exp\left[-\frac{1}{2}\text{tr}(\tilde{M}^2) - \frac{\tilde{g}}{4N}\text{tr}(\tilde{M}^4)\right], \quad (2.93)$$

where

$$\tilde{g} = \frac{g}{(1 - 2g\tilde{\Pi}_2)^2}.$$

So the Green's functions  $\tilde{\Pi}_{2n}(g)$  in that all tadpole contribution are dropped out can be expressed in terms of full Green's functions  $\Pi_{2n}(g)$

$$\tilde{\Pi}_{2n}(g) = (1 - 2g\tilde{\Pi}_2)^{-n} \Pi_{2n}\left(\frac{g}{(1 - 2g\tilde{\Pi}_2)^2}\right). \quad (2.94)$$

Now let us reformulate the Boltzmann theory in such way that it reproduces only tadpole-free half-planar graphs. One possible way to do this is to consider the formulation of Boltzmann theory using two fields.

For this purpose let us defined the fields  $\psi$  and  $\phi$  as follows

$$\phi = a + a^+, \quad \psi = b + b^+, \quad (2.95)$$

where  $a$ ,  $a^+$ ,  $b$  and  $b^+$  satisfy the following relations

$$\begin{aligned} aa^+ &= 1, & bb^+ &= 1, \\ ab^+ &= 0, & ba^+ &= 0. \end{aligned} \quad (2.96)$$

This algebra has the realization in the Boltzmannian Fock space. For two degrees of freedom the vacuum  $|0\rangle$  satisfies

$$a|0\rangle = 0, \quad b|0\rangle = 0. \quad (2.97)$$

Now let us define an interaction Green's functions by the formula

$$\mathcal{G}_{k_1 l_1, \dots, k_m, l_m}^{2-field} \equiv \langle 0 | \psi^{k_1} \phi^{l_1} \dots \psi^{k_m} \phi^{l_m} \frac{1}{1 + S_{int}} | 0 \rangle, \quad (2.98)$$

where the interaction  $S_{int}$  has the form

$$S_{int} = g\psi : \phi\phi : \psi = g\psi\phi\phi\psi - g\psi\psi. \quad (2.99)$$

One can see that the connected tadpole-free parts of Green's functions in Boltzmann theory described in subsection 2.2 coincide with the connected parts of Green's functions  $\mathcal{G}_{1, n-2, 1}^{2-field}$

$$F_n \equiv \mathcal{G}_{1, n-2, 1}^{2-field, conn.} = \langle 0 | \psi : \phi^{n-2} : \psi \frac{1}{1 + S_{int}} | 0 \rangle. \quad (2.100)$$

Let us write down the system of Schwinger-Dyson equations for the Green's functions  $F_2$  and  $F_4$

$$\begin{aligned} F_2 &= 1 - gF_4, \\ F_4 &= -gF_2F_4 - gF_2^2. \end{aligned} \quad (2.101)$$

The results of numerical calculation of  $F_2$  and  $F_4$  related to a perturbative branch of solution of (2.101) are presented on Table 2. This solution has a phase transition point  $g_0 = 0$ . When  $g$  goes to  $g_0$  then  $F_2$  and  $F_4$  go to infinity. Also on Table 2 we present the numerical values for  $\tilde{\Pi}_2$  and  $\tilde{\Pi}_4^{connected} = \tilde{\Pi}_4 - 2\tilde{\Pi}_2^2$  for  $g < g_0 = 0.421875$ , where  $g_0$  is determined from the following equation

$$1 - 2g\tilde{\Pi}_2 = 0. \quad (2.102)$$

Table 2

$g$	$10^{-3}$	$10^{-2}$	$10^{-1}$	0.4	0.421870	0.9	0.99
$F_2$	1.00	1.00	1.01	1.14	1.16	2.82	9.56
$\tilde{\Pi}_2$	1.00	1.00	1.01	1.16	1.18	—	—
$F_4$	$-9.99 \cdot 10^{-4}$	$-9.90 \cdot 10^{-3}$	-0.0925	-0.359	-0.382	-2.03	-8.64
$\tilde{\Pi}_4^{connected}$	$-9.98 \cdot 10^{-4}$	$-9.81 \cdot 10^{-3}$	-0.0872	-0.394	-0.439	—	—

Perturbation series for  $F_2$ ,  $F_4$ ,  $\tilde{\Pi}_2$  and  $\tilde{\Pi}_4^{connected}$  have the forms

$$F_2 = \frac{-1 + g + \sqrt{1 + 2g - 3g^2}}{2g(1 - g)} = 1 + g^2 - g^3 + 3g^4 - 6g^5 + \dots,$$

$$F_4 = \frac{1 + g - 2g^2 - \sqrt{1 + 2g - 3g^2}}{2g^2(1 - g)} = -g + 2g^2 - 5g^3 + 6g^4 - 15g^5 + \dots, \quad (2.103)$$

$$\begin{aligned} \tilde{\Pi}_2 &= 1 + g^2 - 2g^3 + 10g^4 - 42g^5 + \dots, \\ \tilde{\Pi}_4^{connected} &= -g + 2g^2 - 10g^3 + 42g^4 - 209g^5 + \dots. \end{aligned} \quad (2.104)$$

### 3 Boltzmann Theory for Finite Number of Degree of Freedom

#### 3.1 The Schwinger-Dyson Equations

In this section we will study the Boltzmannian Schwinger-Dyson equations for the theory with finite number of degrees of freedom.

First of all let us derive the Boltzmannian Schwinger-Dyson equations. This can be done similarly to the zero-dimensional case. We adopt the following notations. Let  $a, b, c, \dots$  are multi-indices which label degrees of freedom,  $\phi(a) = \phi^+(a) + \phi^-(a)$ , where  $\phi^+(a)$  and  $\phi^-(a)$  satisfy the relation

$$\phi^-(a)\phi^+(b) = G^{(0)}(a, b) \quad (3.1)$$

and  $G^{(0)}(a, b)$  is a matrix which has the inverse  $K(a, b)$ :

$$\sum_c K(a, c)G(c, b) = \delta(a, b). \quad (3.2)$$

The algebra (3.1) has the realization in the Boltzmannian Fock space generated by the vacuum  $|0\rangle$ ,  $\phi^-(a)|0\rangle = 0$ , and  $n$ -particle states

$$|a_1, \dots, a_n\rangle = \phi^+(a_1)\dots\phi^+(a_n)|0\rangle. \quad (3.3)$$

Note that states (3.3) have no any symmetry properties under permutation of particles because there is no relations between  $\phi^+(a)\phi^+(b)$  and  $\phi^+(b)\phi^+(a)$ .

Free correlation functions

$$G^{(0)}(a_1, \dots, a_n) = \langle 0|\phi(a_1)\dots\phi(a_n)|0\rangle$$

in the Boltzmannian Fock space satisfy the relations

$$\begin{aligned} & \sum_c K(a_k, c)G^{(0)}(a_1, \dots, a_{k-1}, c, a_{k+1}, a_n) = \\ & = \sum_{p=k+1}^n \delta(a_k, a_p)G^{(0)}(a_{k+1}, \dots, a_{p-1})G^{(0)}(a_1, \dots, a_{k-1}, a_{p+1}, \dots, a_n) + \\ & \quad \sum_{p=1}^{k-1} \delta(a_p, a_k)G^{(0)}(a_{p+1}, \dots, a_{k-1})G^{(0)}(a_1, \dots, a_{p-1}, a_{k+1}, \dots, a_n), \end{aligned} \quad (3.4)$$

that follow from the Wick theorem in the Boltzmannian Fock space. We also call equations (3.4) the free Schwinger-Dyson equations.

Interacting Green's functions  $\mathcal{G}(a_1, \dots, a_n)$  are defined by an analogy with the 0-dimensional model:

$$\mathcal{G}(a_1, \dots, a_n) = \langle 0|\phi(a_1)\dots\phi(a_n)\Omega(\phi)|0\rangle, \quad \Omega(\phi) = \frac{1}{1 + V_{int}(\phi)}. \quad (3.5)$$

Let us note that the Green's functions (3.5) have a symmetry under the permutation of arguments in inverse order

$$\mathcal{G}(a_1, \dots, a_n) = \mathcal{G}(a_n, \dots, a_1). \quad (3.6)$$

There are no another symmetry properties.

The form of  $V_{int}(\phi)$  depends on the model under consideration. We are restricted ourself to the case with  $V_{int}$  in the form

$$V_{int}(\phi) = g \sum_a (\phi(a))^r. \quad (3.7)$$

To derive the Scwinger-Dyson equations for correlation functions (3.5) let us rewrite the Green's function (3.5) in terms of the free Green's functions,

$$\begin{aligned} \mathcal{G}(a_1, \dots, a_n) &= \sum_{m=0}^{\infty} \sum_{b_1, \dots, b_m} (-g)^m \langle 0 | \phi(a_1) \dots \phi(a_n) (\phi(b_1))^r \dots (\phi(b_m))^r | 0 \rangle = \\ &= \sum_{m=0}^{\infty} \sum_{b_1, \dots, b_m} G^{(0)}(a_1, \dots, a_n, \underbrace{b_1, \dots, b_1}_r, \dots, \underbrace{b_m, \dots, b_m}_r) \end{aligned} \quad (3.8)$$

Using the free Schwinger-Dyson equations (3.4) we have

$$\begin{aligned} &\sum_c K(a_k, c) \mathcal{G}(a_1, \dots, a_{k-1}, c, a_{k+1}, \dots, a_n) = \\ &\sum_c K(a_k, c) \sum_{m=0}^{\infty} \sum_{b_1, \dots, b_m} (-g)^m G^{(0)}(a_1, \dots, a_{k-1}, c, a_{k+1}, a_n, \underbrace{b_1, \dots, b_1}_r, \dots, \underbrace{b_m, \dots, b_m}_r) = \\ &= J_I + J_{II} + J_{III}, \end{aligned} \quad (3.9)$$

where

$$\begin{aligned} J_I &= \sum_{m=0}^{\infty} \sum_{b_1, \dots, b_m} \sum_{p=1}^{k-1} (-g)^m \delta(a_p, a_k) G^{(0)}(a_1, \dots, a_{p-1}, a_{k+1}, \dots, a_n, \underbrace{b_1, \dots, b_1}_r, \dots, \underbrace{b_m, \dots, b_m}_r) \times \\ &\times G^{(0)}(a_{p+1}, \dots, a_{k-1}) \end{aligned} \quad (3.10)$$

$$\begin{aligned} J_{II} &= \sum_{m=0}^{\infty} \sum_{b_1, \dots, b_m} \sum_{p=k+1}^n (-g)^m \delta(a_k, a_p) G^{(0)}(a_1, \dots, a_{k-1}, a_{p+1}, \dots, a_n, \underbrace{b_1, \dots, b_1}_r, \dots, \underbrace{b_m, \dots, b_m}_r) \times \\ &\times G^{(0)}(a_{k+1}, \dots, a_{p-1}) \end{aligned} \quad (3.11)$$

$$\begin{aligned} J_{III} &= \sum_{b_1, \dots, b_m} \sum_{l=1}^m \sum_{s=1}^r (-g)^m \delta(a_k, b_l) G^{(0)}(a_1, \dots, a_{k-1}, \underbrace{b_1, \dots, b_1}_r, \dots, \underbrace{b_{l-1}, \dots, b_{l-1}}_r, \underbrace{b_l, \dots, b_l}_{s-1}) \times \\ &\times G^{(0)}(\underbrace{b_l, \dots, b_l}_{r-s}, a_{k+1}, \dots, a_n, \underbrace{b_{l+1}, \dots, b_{l+1}}_r, \dots, \underbrace{b_m, \dots, b_m}_r). \end{aligned} \quad (3.12)$$

Using the relation

$$\sum_{m=0}^{\infty} \sum_{l=1}^m f(m, l) = \sum_{l=1}^{\infty} \sum_{m=l}^{\infty} f(m, l)$$

and making the summation over  $b_l$  and then changing the summation index

$$m \rightarrow m' = m - l,$$

one can represent the term  $J_{III}$  in the form

$$\begin{aligned} J_{III} &= \sum_{l=1}^{\infty} \sum_{m'=0}^{\infty} \sum_{b_i} \sum_{s=1}^r (-g)^m G^{(0)}(a_1, \dots, a_{k-1}, \underbrace{b_1, \dots, b_1}_r, \dots, \underbrace{b_{l-1}, \dots, b_{l-1}}_r, \underbrace{a_k, \dots, a_k}_{s-1}) \times \\ &\quad \times G^{(0)}(\underbrace{a_k, \dots, a_k}_{r-s}, a_{k+1}, \dots, a_n, \underbrace{b_{l+1}, \dots, b_{l+1}}_r, \dots, \underbrace{b_{m'+l}, \dots, b_{m'+l}}_r) = \\ &\quad - g \sum_{s=1}^r \mathcal{G}(a_1, \dots, a_{k-1}, \underbrace{a_k, \dots, a_k}_{s-1}) \mathcal{G}(a_{k+1}, \dots, a_n) \end{aligned} \quad (3.13)$$

Putting all together we obtain the half-plane Schwinger-Dyson equations

$$\begin{aligned} &\sum_c K(a_k, c) \mathcal{G}(a_1, \dots, a_{k-1}, c, a_{k+1}, \dots, a_n) = \\ &\sum_{p=1}^{k-1} \delta(a_p, a_k) \mathcal{G}(a_1, \dots, a_{p-1}, a_{k+1}, \dots, a_n) G^{(0)}(a_{p+1}, \dots, a_{k-1}) + \\ &\sum_{p=k+1}^n \delta(a_k, a_p) \mathcal{G}(a_1, \dots, a_{k-1}, a_{p+1}, \dots, a_n) G^{(0)}(a_{k+1}, \dots, a_{p-1}) - \\ &g \sum_{s=1}^r \mathcal{G}(a_1, \dots, a_{k-1}, \underbrace{a_k, \dots, a_k}_{s-1}) \mathcal{G}(\underbrace{a_k, \dots, a_k}_{r-s}, a_{k+1}, \dots, a_n). \end{aligned} \quad (3.14)$$

Also we have the equations

$$\mathcal{G}(a_1, \dots, a_n) = G^{(0)}(a_1, \dots, a_n) - g \sum_b \mathcal{G}(a_1, \dots, a_n, \underbrace{b, \dots, b}_r) \quad (3.15)$$

which follow from the average the operator identity

$$\frac{1}{1 + V_{int}} = 1 - \frac{V_{int}}{1 + V_{int}}. \quad (3.16)$$

Let us consider the interaction  $g \sum_a [\phi(a)]^4$ , and write down the Scwinger-Dyson equations (3.14) corresponding to  $(n, k) = (2, 1), (4, 2)$ . We have

$$\sum_e K(a, e) \mathcal{G}(e, b) = \delta(a, b) \mathcal{G} - g \mathcal{G}(a, b) \mathcal{G}(a, a) - g \mathcal{G}(a, a, a, b) \mathcal{G}, \quad (3.17)$$

$$\begin{aligned} \sum_e K(b, e) \mathcal{G}(a, e, c, d) &= \delta(b, c) \mathcal{G}(a, d) + \delta(a, b) \mathcal{G}(c, d) - \\ &g \mathcal{G}(c, d) \mathcal{G}(a, b, b, b) - g \mathcal{G}(a, b) \mathcal{G}(b, b, c, d), \end{aligned} \quad (3.18)$$

where  $\mathcal{G}$  is vacuum Green's function. Equation (3.17) and (3.18) together with the equation for vacuum Green's function that follows from (3.15)

$$\mathcal{G} = 1 - g \sum_a \mathcal{G}(a, a, a, a) \quad (3.19)$$

form the closed system for  $\mathcal{G}$ ,  $\mathcal{G}(a, b)$  and  $\mathcal{G}(a, b, c, d)$ .

### 3.2 Diagonal Kinetic Operator

In this subsection we will study the theory with  $K$  degrees of freedom and diagonal kinetic operator. We assume the following form of Lagrangian

$$\mathcal{L} = \frac{1}{2} \sum_{a=1}^K \Phi_a^2 + g \sum_{a=1}^K \Phi_a^4. \quad (3.20)$$

The latin indices  $a, b, c, \dots$  run the values  $1, 2, \dots, K$ . The operators  $\Phi_a$  are the sum of Boltzmann creation and annihilation operators  $\Phi_a = \Phi_a^+ + \Phi_a^-$  which satisfy the relation

$$\Phi_a^- \Phi_b^+ = \delta_{a,b}. \quad (3.21)$$

The Green's functions are defined by

$$\mathcal{G}(a, b, \dots, c) \equiv \mathcal{G}_{ab\dots c} = \langle 0 | \Phi_a \Phi_b \dots \Phi_c \frac{1}{1 + g \sum_a \Phi_a^4} | 0 \rangle. \quad (3.22)$$

It is evident that

$$\underbrace{\mathcal{G}_{a\dots a}}_n = \underbrace{\mathcal{G}_{b\dots b}}_n \quad (3.23)$$

for any  $a$  and  $b$  and

$$\mathcal{G}_{abb\dots b} = 0 \quad (3.24)$$

for  $a \neq b$ .

Let us write down the equations (3.17), (3.18) and (3.19) for this case:

$$\mathcal{G}_{aa} = \mathcal{G} - g\mathcal{G}_{aa}^2 - g\mathcal{G}\mathcal{G}_{aaaa}, \quad (3.25)$$

$$\mathcal{G}_{aaaa} = 2\mathcal{G}_{aa} - 2g\mathcal{G}_{aa}\mathcal{G}_{aaaa}, \quad (3.26)$$

$$\mathcal{G} = 1 - Kg\mathcal{G}_{aaaa}. \quad (3.27)$$

From these equations one can write the equations for  $\mathcal{G}$ :

$$4g\mathcal{G}^4 + 12(K-1)g\mathcal{G}^3 + [12(K-1)^2g + K]\mathcal{G}^2 + [2K(K-1) + 4g(K-1)^3]\mathcal{G} - K(2K-1) = 0. \quad (3.28)$$

This equation can be solved and the Green's functions  $\mathcal{G}_{aa}$  and  $\mathcal{G}_{aaaa}$  are expressed in terms of  $\mathcal{G}$ .

### 3.3 Two Degree of Freedom and Non-Diagonal Quadratic Kinetic Operator

In this subsection we shall consider the theory with two degree of freedom and non-diagonal kinetic operator. The Lagrangian has the form

$$\mathcal{L} = \frac{1}{2} \sum_{a,b} K_{a,b} \Phi_a \Phi_b + g \sum_a \Phi_a^4. \quad (3.29)$$

The indices  $a, b, c, \dots$  will take the values 1 and 2. We adopt the following parametrization of the kinetic operator  $K_{ab}$

$$K_{11} = K_{22} = \alpha, \quad K_{12} = K_{21} = -\beta. \quad (3.30)$$

In this case we have

$$\Phi_1^- \Phi_1^+ = \Phi_2^- \Phi_2^+ = \frac{\alpha}{\alpha^2 - \beta^2}, \quad \Phi_1^- \Phi_2^+ = \Phi_2^- \Phi_1^+ = \frac{\beta}{\alpha^2 - \beta^2}. \quad (3.31)$$

The Lagrangian is invariant under the transformations  $\Phi_1 \rightarrow \Phi_2$ ,  $\Phi_2 \rightarrow \Phi_1$ . Therefore all Green's functions are invariant under the change of indices  $1 \rightarrow 2$ ,  $2 \rightarrow 1$ . In particular, we have

$$\mathcal{G}_{ab} = \mathcal{G}_{ba}, \quad (3.32)$$

$$\underbrace{\mathcal{G}_{a\dots a}}_n = \underbrace{\mathcal{G}_{b\dots b}}_n \quad (3.33)$$

for any  $a, b$  and  $n$ .

Let us write (3.19), (3.17) for  $(a, b) = (1, 1)$ ,  $(1, 2)$  and (3.18) for  $(a, b, c, d) = (1, 1, 1, 1)$ ,  $(2, 1, 1, 1)$ ,  $(1, 2, 1, 1)$ ,  $(2, 2, 1, 1)$ :

$$\mathcal{G} = 1 - g\mathcal{G}_{1111} - g\mathcal{G}_{2222}, \quad (3.34)$$

$$\alpha\mathcal{G}_{11} - \beta\mathcal{G}_{21} = \mathcal{G} - g\mathcal{G}_{11}^2 - g\mathcal{G}_{1111}\mathcal{G}, \quad (3.35)$$

$$\alpha\mathcal{G}_{12} - \beta\mathcal{G}_{22} = -g\mathcal{G}_{12}\mathcal{G}_{11} - g\mathcal{G}_{1112}\mathcal{G}, \quad (3.36)$$

$$\alpha\mathcal{G}_{1111} - \beta\mathcal{G}_{1211} = 2\mathcal{G}_{11} - 2g\mathcal{G}_{11}\mathcal{G}_{1111}, \quad (3.37)$$

$$\alpha\mathcal{G}_{2111} - \beta\mathcal{G}_{2211} = \mathcal{G}_{21} - g\mathcal{G}_{11}\mathcal{G}_{2111} - g\mathcal{G}_{21}\mathcal{G}_{1111}, \quad (3.38)$$

$$-\beta\mathcal{G}_{1111} + \alpha\mathcal{G}_{1211} = -g\mathcal{G}_{11}\mathcal{G}_{1222} - g\mathcal{G}_{12}\mathcal{G}_{2211}, \quad (3.39)$$

$$-\beta\mathcal{G}_{2111} + \alpha\mathcal{G}_{2211} = \mathcal{G}_{11} - g\mathcal{G}_{11}\mathcal{G}_{2222} - g\mathcal{G}_{22}\mathcal{G}_{2211}. \quad (3.40)$$

The following symmetry properties of Green's functions are evident:

$$\mathcal{G}_{11} = \mathcal{G}_{22}, \quad \mathcal{G}_{12} = \mathcal{G}_{21}, \quad \mathcal{G}_{1111} = \mathcal{G}_{2222},$$

$$\mathcal{G}_{1211} = \mathcal{G}_{2122}, \quad \mathcal{G}_{1122} = \mathcal{G}_{2211}, \quad \mathcal{G}_{1112} = \mathcal{G}_{2221} = \mathcal{G}_{1222} = \mathcal{G}_{2111}. \quad (3.41)$$

So the system (3.34)-(3.40) contains 7 independent equations and 7 unknowns variables  $\mathcal{G}$ ,  $\mathcal{G}_{11}$ ,  $\mathcal{G}_{12}$ ,  $\mathcal{G}_{1111}$ ,  $\mathcal{G}_{1112}$ ,  $\mathcal{G}_{1211}$ ,  $\mathcal{G}_{1122}$  and therefore can be solved.

To get the equations for Green's functions without vacuum insertions one has to set  $\mathcal{G} = 1$  in (3.35) - (3.40). Then we have a system of 6 equations for 6 variables. The numerical solutions of this system for  $\alpha = 1$  and some values of  $\beta$  and  $g$  are presented on Tables 3-5.

Table 3.  $\beta = 0.01$

$g$	$10^{-3}$	$10^{-2}$	$10^{-1}$	1	10	$10^2$	$10^3$
$G_{11}$	$9.97 \cdot 10^{-1}$	$9.72 \cdot 10^{-1}$	$7.99 \cdot 10^{-1}$	$3.98 \cdot 10^{-1}$	$1.26 \cdot 10^{-1}$	$3.2 \cdot 10^{-2}$	$7.45 \cdot 10^{-3}$
$G_{12}$	$9.94 \cdot 10^{-3}$	$9.43 \cdot 10^{-3}$	$6.38 \cdot 10^{-3}$	$1.58 \cdot 10^{-3}$	$1.58 \cdot 10^{-4}$	$1.03 \cdot 10^{-5}$	$1.51 \cdot 10^{-6}$
$G_{1111}$	1.99	1.91	1.38	$4.43 \cdot 10^{-1}$	$7.16 \cdot 10^{-2}$	$8.65 \cdot 10^{-3}$	$9.37 \cdot 10^{-4}$
$G_{1112}$	$1.98 \cdot 10^{-2}$	$1.85 \cdot 10^{-2}$	$1.10 \cdot 10^{-2}$	$1.77 \cdot 10^{-3}$	$9.01 \cdot 10^{-5}$	$2.77 \cdot 10^{-6}$	$6.98 \cdot 10^{-8}$
$G_{1211}$	$1.99 \cdot 10^{-2}$	$1.88 \cdot 10^{-2}$	$1.25 \cdot 10^{-2}$	$3.48 \cdot 10^{-3}$	$5.77 \cdot 10^{-4}$	$7.66 \cdot 10^{-5}$	$8.82 \cdot 10^{-6}$
$G_{1122}$	$9.94 \cdot 10^{-1}$	$9.44 \cdot 10^{-1}$	$6.38 \cdot 10^{-1}$	$1.59 \cdot 10^{-1}$	$1.58 \cdot 10^{-2}$	$1.03 \cdot 10^{-3}$	$5.55 \cdot 10^{-5}$

Table 4.  $\beta = 0.1$

$g$	$10^{-3}$	$10^{-2}$	$10^{-1}$	1	10	$10^2$	$10^3$
$G_{11}$	1.01	$9.80 \cdot 10^{-1}$	$8.03 \cdot 10^{-1}$	$3.98 \cdot 10^{-1}$	$1.26 \cdot 10^{-1}$	$3.20 \cdot 10^{-2}$	$7.45 \cdot 10^{-3}$
$G_{12}$	$1.00 \cdot 10^{-1}$	$9.52 \cdot 10^{-2}$	$6.4 \cdot 10^{-2}$	$1.58 \cdot 10^{-2}$	$1.58 \cdot 10^{-3}$	$1.03 \cdot 10^{-4}$	$1.51 \cdot 10^{-5}$
$G_{1111}$	2.03	1.94	1.39	$4.45 \cdot 10^{-1}$	$7.17 \cdot 10^{-2}$	$8.66 \cdot 10^{-3}$	$9.37 \cdot 10^{-4}$
$G_{1112}$	$2.02 \cdot 10^{-1}$	$1.89 \cdot 10^{-1}$	$1.11 \cdot 10^{-1}$	$1.77 \cdot 10^{-2}$	$9.00 \cdot 10^{-4}$	$2.77 \cdot 10^{-5}$	$6.96 \cdot 10^{-7}$
$G_{1211}$	$2.03 \cdot 10^{-1}$	$1.91 \cdot 10^{-1}$	$1.26 \cdot 10^{-1}$	$3.50 \cdot 10^{-2}$	$5.79 \cdot 10^{-3}$	$7.67 \cdot 10^{-4}$	$8.83 \cdot 10^{-5}$
$G_{1122}$	1.02	$9.71 \cdot 10^{-1}$	$6.50 \cdot 10^{-1}$	$1.59 \cdot 10^{-1}$	$1.58 \cdot 10^{-2}$	$1.02 \cdot 10^{-3}$	$5.51 \cdot 10^{-5}$

Table 5.  $\beta = 0.9$

$g$	$10^{-3}$	$10^{-2}$	$10^{-1}$	1	10	$10^2$	$10^3$
$G_{11}$	4.63	2.78	1.03	$3.05 \cdot 10^{-1}$	$7.94 \cdot 10^{-2}$	$1.91 \cdot 10^{-2}$	$4.34 \cdot 10^{-3}$
$G_{12}$	4.11	2.28	$6.37 \cdot 10^{-1}$	$1.03 \cdot 10^{-1}$	$1.16 \cdot 10^{-2}$	$9.86 \cdot 10^{-4}$	$6.60 \cdot 10^{-5}$
$G_{1111}$	44.9	19.7	4.33	$6.95 \cdot 10^{-1}$	$8.68 \cdot 10^{-2}$	$9.46 \cdot 10^{-3}$	$9.77 \cdot 10^{-4}$
$G_{1112}$	39.8	15.8	2.27	$1.40 \cdot 10^{-1}$	$5.06 \cdot 10^{-3}$	$1.43 \cdot 10^{-4}$	$3.55 \cdot 10^{-6}$
$G_{1211}$	40.1	16.9	3.51	$5.66 \cdot 10^{-1}$	$7.31 \cdot 10^{-2}$	$8.20 \cdot 10^{-3}$	$8.62 \cdot 10^{-4}$
$G_{1122}$	40.1	16.0	2.38	$1.68 \cdot 10^{-1}$	$8.39 \cdot 10^{-3}$	$4.02 \cdot 10^{-4}$	$1.94 \cdot 10^{-5}$

The dependence of the 2-point Green's functions  $G_{11}$  and  $G_{12}$  on the coupling constant  $g$  for different values of  $\beta$  is also presented on Fig.8.

The limit  $\beta \rightarrow 0$  corresponds to decoupling of the degrees of freedom. In this limit the mixed Green's function  $G_{12}$  goes to zero and we reproduce the case of one degree of freedom. For  $\beta = 0.9$  the mixed Green's function is of the same order as the diagonal Green's function.

## 4 Boltzmann Correlation Functions in $D$ -Dimensional Space-Time

### 4.1 The Schwinger-Dyson Equations

In this section we will derive the Schwinger-Dyson equations for Boltzmann correlation functions in  $D$ -dimensional Euclidean space.

We adopt the following notations. Let

$$\phi(x) = \phi^+(x) + \phi^-(x) \quad (4.1)$$



be the Boltzmann field with creation and annihilation operators satisfying the relation

$$\phi^-(x)\phi^+(y) = D(x, y), \quad (4.2)$$

where

$$D(x, y) = \frac{1}{(2\pi)^D} \int d^D p \frac{e^{-ip(x-y)}}{p^2 + m^2} \quad (4.3)$$

is  $D$ -dimensional Euclidean propagator. In what follows we will assume that  $\phi(x)$  is a scalar field. A generalization to the case when  $\phi$  carries isotopic or tensor indices is straightforward.

By analogy with the case of finite number degrees of freedom we consider the following correlation functions

$$F_n(x_n, \dots, x_1) = \langle 0 | \phi(x_n) \dots \phi(x_1) \frac{1}{1 + \int d^D x \mathcal{L}_{int}(\phi(x))} | 0 \rangle, \quad (4.4)$$

where  $\mathcal{L}_{int}(\phi(x))$  is a local invariant polynomial in the field and its derivatives. As before we restrict ourself by the case of the quartic interaction  $\mathcal{L}_{int}(\phi) = g\phi^4$ .

Using the results of the previous section one can immediately write down the Boltzmannian Schwinger-Dyson equations for correlation functions (4.4). We have

$$\begin{aligned} (-\Delta + m^2)_{x_{2l}} F_{2n}(x_{2n}, \dots, x_1) &= -g(F_{2l}(x_{2l}, x_{2l-1}, \dots, x_1) F_{2n-2l+2}(x_{2n}, \dots, x_{2l+1}, x_{2l}, x_{2l}) + \\ &\quad F_{2l+2}(x_{2l}, x_{2l}, x_{2l}, x_{2l-1}, \dots, x_1) F_{2n-2l}(x_{2n}, \dots, x_{2l+1})) + \\ &\quad \sum_{i < 2l} \delta(x_{2l} - x_i) F_{2n-2l+i-1}(x_{2n}, \dots, x_{2l+1}, x_{i-1}, \dots, x_1) F_{2l-i-1}^{(0)}(x_{2l-1}, \dots, x_{i+1}) + \\ &\quad \sum_{2l < i} \delta(x_{2l} - x_i) F_{2n+2l-i-1}(x_{2n}, \dots, x_{i+1}, x_{2l-1}, \dots, x_1) F_{i-2l-1}^{(0)}(x_{i-1}, \dots, x_{2l+1}), \quad l \leq n, \end{aligned} \quad (4.5)$$

and the similar equations for  $x_{2l+1}$

$$\begin{aligned} (-\Delta + m^2)_{x_{2l+1}} F_{2n}(x_{2n}, \dots, x_1) &= \\ &= -g(F_{2l}(x_{2l}, x_{2l-1}, \dots, x_1) F_{2n-2l+2}(x_{2n}, \dots, x_{2l+2}, x_{2l+1}, x_{2l+1}, x_{2l+1}) + \\ &\quad F_{2l+2}(x_{2l+1}, x_{2l+1}, x_{2l}, \dots, x_1) F_{2n-2l}(x_{2n}, \dots, x_{2l+2}, x_{2l+1})) + \\ &\quad \sum_{i < 2l+1} \delta(x_{2l+1} - x_i) F_{2n-2l+i-2}(x_{2n}, \dots, x_{2l+2}, x_{i-1}, \dots, x_1) F_{2l-i}^{(0)}(x_{2l}, \dots, x_{i+1}) + \\ &\quad \sum_{i > 2l+1} \delta(x_{2l+1} - x_i) F_{2n+2l-i}(x_{2n}, \dots, x_{i+1}, x_{2l}, \dots, x_1) F_{i-2l-2}^{(0)}(x_{i-1}, \dots, x_{2l+2}), \quad l \leq n. \end{aligned} \quad (4.6)$$

Let us compare this set of equations with the usual Schwinger-Dyson equations and with the planar Schwinger-Dyson equations. The usual Schwinger-Dyson equations for scalar field with  $\varphi^4$  interaction have the form

$$\begin{aligned} (-\Delta + m^2)_{x_n} G_n(x_n, \dots, x_1) &= -g G_{n+2}(x_n, x_n, x_n, x_{n-1}, \dots, x_1) + \\ &\quad \sum_{i=1}^{n-1} \delta(x_n - x_i) G_{n-2}(x_{n-1}, \dots, x_{i-1}, x_{i+1}, \dots, x_1) \end{aligned} \quad (4.7)$$

and  $G_n(x_n, \dots, x_1)$  is a symmetric function of its arguments.

To write down the planar Schwinger-Dyson equations one has to modify in (4.7) only the Schwinger's terms:

$$\begin{aligned} (-\Delta + m^2)_{x_n} \Pi_n(x_n, x_n, x_n, \dots, x_1) &= -g \Pi_{n+2}(x_n, x_n, x_n, x_{n-1}, \dots, x_1) + \\ &+ \sum_{i=1}^{n-1} \delta(x_n - x_i) \Pi_{i-1}(x_{i-1}, \dots, x_1) \Pi_{n-i-1}(x_{n-1}, \dots, x_{i+1}), \end{aligned} \quad (4.8)$$

where

$$\Pi_n(x_n, \dots, x_1) = \lim_{N \rightarrow \infty} \frac{1}{N^{1+n/2}} < \text{tr} (M(x_n) \dots M(x_1)) > \quad (4.9)$$

and  $\Pi_n(x_n, \dots, x_1)$  is invariant under cyclic permutations of its arguments. The Schwinger terms for the Boltzmannian Schwinger-Dyson equations differ from the Schwinger terms for the planar Schwinger-Dyson equations. From (4.5) we see that the Schwinger terms are linear with respect to the interacting Boltzmann correlation functions meanwhile the Schwinger terms in the planar equations are quadratic with respect to the planar correlation functions. There is also a modification in the term representing the interaction. Instead of the linear term for full or planar equations we have quadratic terms in the Boltzmannian Schwinger-Dyson equations. The usual Schwinger-Dyson equations may be written in the operator form as follows

$$\frac{\delta(S_0 + S_{int})[\varphi]}{\delta\varphi(x)} + \text{Schwinger's terms} = 0. \quad (4.10)$$

The planar Schwinger-Dyson equations in the operator form can be presented in terms of the master field  $\Phi$  and the master momentum  $\Pi$  [5, 19, 18, 20]

$$\left[ i \frac{\delta(S_0 + S_{int})[\Phi]}{\delta\Phi(x)} + 2\Pi(x) \right] |0\rangle = 0, \quad (4.11)$$

where  $S$  is an action and  $\Phi$  and  $\Pi$  satisfy [5, 37]

$$[\Pi(x), \Phi(y)] = i\delta^{(D)}(x - y) |0\rangle \langle 0|. \quad (4.12)$$

The Boltzmannian Schwinger-Dyson equations can be written down schematically as

$$\begin{aligned} \frac{\delta S_0[\Phi]}{\delta\Phi(x)} + \frac{\delta S_{int}[\Phi]}{\delta\Phi(x)} |\Omega\rangle \langle 0| + \frac{\delta^2 S_{int}[\Phi]}{\delta\Phi(x)^2} |\Omega\rangle \langle 0| \Phi(x) + \dots + \\ \Phi(x) |\Omega\rangle \langle 0| \frac{\delta^2 S_{int}[\Phi]}{\delta\Phi(x)^2} + |\Omega\rangle \langle 0| \frac{\delta S_{int}[\Phi]}{\delta\Phi(x)} + \text{Schwinger's terms} = 0. \end{aligned} \quad (4.13)$$

We see that the Boltzmannian Schwinger-Dyson equations in the operator form are more complicated than the usual Schwinger-Dyson equations since the interaction terms contain projectors on the vacuum state. But as we will see in the next subsection just due to these projectors it will be possible to get a closed set of integral equations for two- and four-point Green's functions.

## 4.2 A Closed System of Equations for Two- and Four-Point Green's Functions

Let us write down equations (4.5) and (4.6) for the two-point correlation function

$$(-\Delta + m^2)_x F_2(x, y) = -gF_2(x, y)F_2(x, x) - gF_4(x, x, x, y) + \delta(x - y), \quad (4.14)$$

$$(-\Delta + m^2)_y F_2(x, y) = -gF_2(y, y)F_2(x, y) - gF_4(x, y, y, y) + \delta(x - y), \quad (4.15)$$

and the four-point correlation function

$$\begin{aligned} (-\Delta + m^2)_x F_4(x, y, z, t) &= -gF_4(x, y, z, t)F_2(x, x) - gF_6(x, x, x, y, z, t) + \\ &\delta(x - y)F_2(z, t) + \delta(x - t)F_2^{(0)}(y, z), \end{aligned} \quad (4.16)$$

$$\begin{aligned} (-\Delta + m^2)_y F_4(x, y, z, t) &= -gF_2(z, t)F_4(x, y, y, y) - gF_4(y, y, z, t)F_2(x, y) + \\ &\delta(x - y)F_2(z, t) + \delta(y - z)F_2(x, t), \end{aligned} \quad (4.17)$$

$$\begin{aligned} (-\Delta + m^2)_z F_4(x, y, z, t) &= -gF_2(z, t)F_4(x, y, z, z) - gF_4(z, z, z, t)F_2(x, y) + \\ &\delta(z - t)F_2(x, y) + \delta(y - z)F_2(x, t), \end{aligned} \quad (4.18)$$

$$\begin{aligned} (-\Delta + m^2)_t F_4(x, y, z, t) &= -gF_6(x, y, z, t, t, t) - gF_2(t, t)F_4(x, y, z, t) + \\ &\delta(z - t)F_2(x, y) + \delta(x - t)F_2^{(0)}(y, z). \end{aligned} \quad (4.19)$$

Here we assume that all vacuum insertions are dropped out. Note that not all these equations are independent. Indeed, having in mind the symmetry of half-plane Green's functions under the permutation of their arguments in the inverse order (3.6) one can reproduce equations (4.15), (4.17) and (4.19) from equations (4.14), (4.18) and (4.16), respectively.

We see that equations (4.18) and (4.17) in accordance with the general formula (4.13) do not contain six-point correlation functions. Let us show that from (4.17) and (4.14) one can get a closed set of integral equations which is sufficient to find  $F_2$  and  $F_4$ . To this purpose let us rewrite (4.17) in the integral form

$$\begin{aligned} F_4(x, y, z, t) &= -g \int D(y, u) [F_2(z, t)F_4(x, u, u, u) + F_4(u, u, z, t)F_2(x, u)] du + \\ &D(x, y)F_2(z, t) + D(y, z)F_2(x, t) \end{aligned} \quad (4.20)$$

(see Fig. 10). The integral representation for the Schwinger-Dyson equation (4.14) is drawn on Fig. 9. As has been mentioned above the Boltzmann correlation functions do not possess any symmetry property except the invariance (3.6). Therefore drawing correlations functions one has to mark the order of the external lines. The possibility to

do this is to draw arguments of the correlation function on a line as it is done on Figs. 9 and 10.

For the two-point correlation function we have

$$F_2(x, y) = -g \int [D(x, u)F_2(u, u)F_2(u, y) + D(x, u)F_4(u, u, u, y)]du + D(x, y), \quad (4.21)$$

(see Fig.9).

From (4.20) and (4.21) one gets the relation between  $\mathcal{F}_4(x, y, z, t)$ , the connected part of  $F_4(x, y, z, t)$ , and  $F_2(x, y)$ . To write down this relation note that

$$F_4(x, y, z, t) = \mathcal{F}_4(x, y, z, t) + F_2(x, y)F_2(z, t) + F_2(x, t)D(y, z), \quad (4.22)$$

(see Fig.11). Finally we get

$$\mathcal{F}_4(x, y, z, t) = -g \int F_2(x, u)D(y, u)[D(u, z)F_2(u, t) + \mathcal{F}_4(u, u, z, t)]du \quad (4.23)$$

$$F_2(x, y) = D(x, y) - g \int D(x, u)[D(u, u)F_2(u, y) + 2F_2(u, u)F_2(u, y) + \mathcal{F}_4(u, u, u, y)]du. \quad (4.24)$$

Let us write down this system in a more suitable form. Note that there are tadpole contributions in the right hand side of equation (4.24). It is convenient to include these terms into a mass renormalization. To this purpose let us substitute the representation (4.22) in (4.15). We have

$$(-\Delta + m^2)_y F_2(x, y) = -g(2c_1 + c_0)F_2(x, y) - g\mathcal{F}_4(x, y, y, y) + \delta(x - y), \quad (4.25)$$

where  $c_1 = F_2(x, x)$ ,  $c_0 = D(x, x)$ . Including these constants in a new mass  $M$  we get

$$F_2(x, y) = D_M(x - y) - g \int du \mathcal{F}_4(x, u, u, u)D_M(u, y). \quad (4.26)$$

Instead of equation (4.23) it is more convenient to deal with an equation for a *partially* one-particle irreducible (1PI) 4-point function  $\Gamma_4(x, y, z, t)$  which is defined as

$$\Gamma_4 = F_2^{-1}D^{-1}D^{-1}F_2^{-1}\mathcal{F}_4, \quad (4.27)$$

or more precisely

$$\Gamma_4(x, y, z, t) = \int F_2^{-1}(x, x')D^{-1}(y, y')D^{-1}(z, z')F_2^{-1}(t, t')\mathcal{F}_4(x', y', z', t')dx'dy'dz'dt'. \quad (4.28)$$

Note that in the right hand side of (4.28) we multiply  $\mathcal{F}_4$  only by two full 2-point Green's functions while in the usual case to get 1PI Green's function one multiplies an  $n$ -point Green's function by  $n$  full 2-point functions. From (4.23) and (4.28) we get

$$\Gamma_4(p, k, r) = -g - g \int dk' F_2(p + k - k')D(k')\Gamma_4(p + k - k', k', r). \quad (4.29)$$

Equation (4.26) can be also rewritten in terms of  $\Gamma_4$

$$F_2(p) = Dp - g \int dk' dk'' D(k')D(k'')F_2(p - k' - k'')\Gamma_4(p - k' - k'', k', k''). \quad (4.30)$$

Equations (4.29) and (4.30) are presented graphically on Fig. 12.

Equation (4.29) is the Bethe-Salpeter-like equation with the kernel which contains an unknown function  $F_2$ . As in the usual case we can write down  $F_2$  in term of self-energy  $\Sigma_2$ ,

$$F_2 = \frac{1}{p^2 + M^2 + \Sigma_2} \quad (4.31)$$

and write down equation (4.26) as an equation for  $\Sigma_2$ , i.e.

$$\Sigma_2(p) = \int dkdq F_2(k) D(q) D(p-k-q) \Gamma_4(p, k, q). \quad (4.32)$$

Equation (4.32) is similar to a usual relation between the self-energy function  $\Sigma_2$  and 4-point vertex function for  $\varphi^4$  field theory. Note that a closed form of the representation for 4-point vertex function (4.29) is a distinctive feature of the Boltzmann field theory.

One can choose an approximation in the system of equations (4.32), (4.29) which gives a so-called rainbow approximation. To get this approximation one takes  $\Gamma_4 \approx -g$  and restricts by the first two terms in the relation (4.31),

$$F_2^{appr} = \frac{1}{p^2 + M^2} - \frac{1}{p^2 + M^2} \Sigma_2 \frac{1}{p^2 + M^2} \quad (4.33)$$

Within this approximation the solution  $\Sigma_2^{appr} \equiv \Pi$  of equations (4.32) is reduced to the solution of the following equation for  $\Pi$

$$\Pi(q) = \Pi_0(q) + g^2 \int \frac{d^4 q'}{(2\pi)^4} \frac{I(q-q')}{(q^2 + M^2)^2} \Pi(q'), \quad (4.34)$$

where  $\Pi_0(q)$  denotes the second order contribution to the self-energy

$$\Pi_0(q) = g^2 \int \frac{d^4 k_1}{(2\pi)^4} \int \frac{d^4 k_2}{(2\pi)^4} \frac{1}{(k_1^2 + m^2)(k_2^2 + m^2)((q - k_1 + k_2)^2 + M^2)}, \quad (4.35)$$

and  $I(q)$  is a "potential"

$$I(p) = \int \frac{d^4 q}{(2\pi)^4} \frac{1}{(q^2 + m^2)((p - q)^2 + m^2)}. \quad (4.36)$$

Equation (4.34) is known as the rainbow equation and it was studied by Rothe [32]. The integrals (4.36) and (4.35) contain divergences. Performing a subtraction one gets the following expression for the renormalized "potential" (for simplicity we assume that  $m = 0$ )

$$I(p) = \frac{1}{(4\pi)^2} \ln\left(\frac{p^2}{\kappa^2}\right) \quad (4.37)$$

with  $\kappa$  being an arbitrary subtraction point. The renormalized second order self-energy has the form (eq. (A.9) from [32])

$$\Pi_0(q) = \frac{M^2 g^2}{2(4\pi)^2} \left\{ A + Bq^2 + \left( \frac{M^2}{q^2} - \frac{q^2}{M^2} \right) \ln\left(1 - \frac{q^2}{M^2}\right) + 2 \int_0^1 \frac{d\chi}{\chi} \ln\left(1 - \chi \frac{q^2}{M^2}\right) \right\}, \quad (4.38)$$

where  $A$  and  $B$  are arbitrary renormalization constants.

For the case of exact equations (4.29), (4.31) and (4.32) one also has to perform appropriate renormalizations. There are two possibilities to discuss renormalizations. One can do an appropriate subtractions directly in the integral equations or one can do them order by order in the perturbative expansion. Both ways are equivalent but the second one is more closed to renormalizations of usual field theories. We are going to discuss it in the next subsection.

### 4.3 Renormalization of the Boltzmann Field Theory

In this subsection we will describe the renormalization of the Boltzmann field theory. To make a formal expression for correlation functions

$$F_n(x_1, \dots, x_n) = \langle 0 | \phi(x_1) \dots \phi(x_n) \frac{1}{1 + \int d^D x L_{int}(\phi(x))} | 0 \rangle, \quad (4.39)$$

finite we apply R-operation [33]. In (4.39)  $\phi(x)$  has the decomposition (4.1) with  $\phi^+(x)$  and  $\phi^-(x)$  satisfying (4.2) and the interaction Lagrangian is an invariant polynomial of  $\phi^+$ ,  $\phi^-$  and its derivatives. The perturbative expansion of Boltzmann correlation functions (4.61) is represented by the sum of half-planar Feynman graphs  $\{H\}$ . We write  $F_H$  for the unrenormalized value of graph  $H$

$$F_H(p_1, \dots, p_n) = \int dk_1 \dots dk_l I_H(k_1, \dots, k_l; p_1, \dots, p_n), \quad (4.40)$$

where  $p_1, \dots, p_n$  are external momenta and the integration is over internal momenta  $k_1, \dots, k_l$ .

Let us apply the standard  $R$ -operation to Boltzmannian Green's functions (4.39). If  $H$  is not a renormalization part ( $H$  has no overall divergence) we set

$$R_H = \bar{R}_H, \quad (4.41)$$

and if  $H$  is a renormalization part ( $H$  is 1PI and has an overall divergence)

$$R_H = (1 - T_H) \bar{R}_H, \quad (4.42)$$

where  $T_H$  is a subtracting operation which fixes the renormalization scheme. The function  $\bar{R}_H$  is defined recursively by

$$\bar{R}_H = I_H + \sum_{\{\gamma_1, \dots, \gamma_s\}} I_{H/\{\gamma_1, \dots, \gamma_s\}} \prod_{i=1}^s (-T_{\gamma_i} \bar{R}_{\gamma_i}). \quad (4.43)$$

The sum in (4.43) is extends over all sets  $\{\gamma_1, \dots, \gamma_s\}$  of renormalization parts of  $H$  which are mutually disjoint and different from  $H$ . The reduced diagram  $H/\{\gamma_1, \dots, \gamma_s\}$  is defined by contracting each  $\gamma_i$  to a point. The explicit formula for the renormalized integrand is given by the forest formula,

$$R_H = (1 + \sum_U \prod_{\gamma \in U} (-T_\gamma)) I_H \quad (4.44)$$

with the sum going over all  $H$ -forests. Up to this point a specific character of the Boltzmann field theory has not been taken into account.

To prove the renormalizability for some given  $\mathcal{L}_{int}$  we have to prove that all subtractions can be collected in corresponding counterterms. At this point we meet with a specific character of the Boltzmann field theory. There is the following subtlety in this step. Half-planar graphs contain renormalization parts which are half-planar as well as renormalization parts which are not belong to the set of half-planar graphs. With an half-planar renormalization part we have to associate the counterterm

$$\mathcal{L}_n(H_n) = (-T_{H_n} \bar{R}_{H_n}) \phi^n. \quad (4.45)$$

Note that there is no the combinatoric factor. We will see that with non-half-planar renormalization parts we have to associate counterterms which are not functions of  $\phi$  but are functions of  $\phi^\pm$ .

To specify our discussion let us consider correlation functions (4.61) for the  $\phi^4$  interaction in  $D = 4$ . To avoid problems with tadpoles we consider the two-field formulation

$$F_n(x_1, \dots, x_n) = \langle 0 | \psi(x_1) \phi(x_2) \phi(x_3) \dots \phi(x_{n-1}) \psi(x_n) \frac{1}{1 + g \int d^D x \psi : \phi \phi : \psi} | 0 \rangle, \quad (4.46)$$

where

$$\begin{aligned} \psi(x) &= \psi^-(x) + \psi^+(x), & \phi(x) &= \phi^-(x) + \phi^+(x), \\ \psi^-(x) \psi^+(y) &= D_M(x, y), & \phi^-(x) \phi^+(y) &= D_m(x, y), \\ \psi^-(x) \phi^+(y) &= \phi^-(x) \psi^+(y) = 0, \\ D_{\mathcal{M}}(x, y) &= \int \frac{d^D k}{(2\pi)^D} \frac{1}{p^2 + \mathcal{M}^2} e^{ik(x-y)}, & \mathcal{M} &= (M, m). \end{aligned} \quad (4.47)$$

We draw  $\phi$ -propagator by thin lines and  $\psi$ -propagator by thick lines. Only two- and four-point graphs may be divergent. Any two-point subgraph of the half-planar graph is also from the set of half-planar graphs and performing contractions of the two-point subgraphs of the half-planar graph one gets again a half-planar graph. But four-point subgraphs of a half-planar graph may be of half-planar type and may be not. We refer to the later case as to the case of subgraphs of  $\Pi$ -type. Particular examples of divergent parts of  $\Pi$ -type of the two-point half-planar graph as well as an examples of half-planar divergent subgraphs are presented on Fig. 13.

At the first sight a four-point divergent part of  $\Pi$ -type requires a counterterms  $\psi^4$ . But a careful examination of half-planar diagram shows that in fact only the counterterms

$$: \psi \psi : \psi^- \psi^- \quad (4.48)$$

are necessary. Indeed, let us consider a graph with a four point divergent part of  $\Pi$ -type. There are two possibilities to make a contraction of this graph to a point, namely, making a contraction to the left vertex  $A$ , or making a contraction to the right vertex  $B$  (see Fig.14). In the both cases after the contractions we are left with half-planar graphs with the insertions

$$: \psi \phi : \psi^- \psi^- \quad (4.49)$$

and

$$\psi^+ \phi^+ : \psi \psi :, \quad (4.50)$$

respectively. One has to choose one of these possibilities. Let us take the first one.

The above consideration shows that reduced graphs  $H/\{\gamma_1, \dots, \gamma_s\}$  are always from the set of half-planar graphs. This fact permits to collect all divergent parts to counterterms

$$\mathcal{L}_{ct}(\psi^+, \psi^-, \phi) = \sum_H \mathcal{L}_n(H_n), \quad (4.51)$$

where the summation is over all renormalization parts. Therefore

$$\mathcal{L}_{ct}(\psi^+, \psi^-, \phi) = (Z_\psi - 1)(\partial\psi_\mu)^2 + \delta M\psi^2 + \delta g\psi : \phi\phi : \psi + \delta\lambda : \psi\psi : \psi^-\psi^-. \quad (4.52)$$

We add counterterms (4.52) to the interaction Lagrangian and consider the renormalized correlation functions

$$F_n(x_1, \dots, x_n) = \langle 0 | \psi(x_1) \phi(x_2) \dots \phi(x_{n-1}) \psi(x_n) \frac{1}{1 + \int d^D x [g\psi : \phi\phi : \psi + \mathcal{L}_{ct}(\psi^+, \psi^-, \phi)]} | 0 \rangle. \quad (4.53)$$

It is easy to see that the counterterms remove all divergencies in the graphs corresponding to (4.53). Indeed, let us consider some half-planar graph  $H_n$ . If  $n > 4$  then  $H_n$  is 1P reducible and it does not require any subtraction. If  $H_2$  and  $H_4$  are overall divergent graphs then these divergences are subtracted by the graph created by the counterterm vertices  $(Z_\psi - 1)(\partial\psi_\mu)^2$ ,  $\delta M\psi^2$  and  $\delta g\psi : \phi\phi : \psi$  respectively. Now let us supposed that  $H_n$  has overall divergent 1PI subgraphs  $\gamma_1, \dots, \gamma_k$ . Since the graphs  $\gamma_1, \dots, \gamma_k$  are overall divergent there are corresponding counterterms in (4.51). Divergent subgraphs may be half-planar ones, that corresponds to the first three terms in (4.52), or  $\Pi$ -type graphs, that corresponds to the last counterterm (4.52). These counterterms produce the graphs in which one or more of overall divergent subgraphs are replaced by their counterterms and there are the corresponding terms in the forest formula. The counterterms (4.52) do not generated new divergences which are not cancelled with divergences of graphs generated by the basic Lagrangian since there is one to one correspondence between the terms of the forest formula and the terms generated by the counterterms (4.52).

The distinctive feature of the Boltzmann theory is that there are the wave function counterterms  $(\delta Z - 1)(\partial\psi)^2$  and the mass counterterms  $\delta m^2\psi^2$  only for  $\psi$ -field (see Fig. 15).

To associate counterterm (4.49) with a change of parameter of the theory it is convenient to add the corresponding term to the interaction Lagrangian,

$$\mathcal{L}_{int}(\psi^+, \psi^-, \phi) = g\psi : \phi\phi : \psi + \lambda : \psi\psi : \psi^-\psi^-. \quad (4.54)$$

Therefore the theory (4.54) is specified by four parameters, two masses  $M$  and  $m$  and two coupling constants  $g$  and  $\lambda$ .

Let us for completeness write down the Boltzmann Schwinger-Dyson equations for the interaction (4.54)

$$\begin{aligned} (-\Delta + M^2)_x F_2(x, y) &= gF_2(x, y)D_M(x, x) - gF_4(x, x, x, y) - \\ &\lambda F_2(x, y)F_2(x, x) + \lambda F_2(x, y)D_M(x, x) + \delta(x - y), \end{aligned} \quad (4.55)$$

$$(-\Delta + m^2)_y F_4(x, y, z, t) = -gF_2(x, y)F_4(y, y, z, t) + \delta(y - z)F_2(x, t). \quad (4.56)$$

We see that equations (4.56) is just equation (4.23) for the connected four-point Green's function. However equation (4.55) for the two-point function contains new terms. From



these equations it follows that equations (4.29) and (4.32) are not changed and instead of (4.31) we have

$$F_2 = \frac{1}{p^2 + M_\lambda^2 + \Sigma_2}, \quad (4.57)$$

where

$$M_\lambda^2 = M^2 + \lambda(F_2(0) - D_M(0)). \quad (4.58)$$

Let us assume dimensional regularization and the minimal subtraction scheme with a scale  $\mu$ . We have

$$\mathcal{L}_{int} = \mu^{4-D} g \psi : \phi \phi : \psi + \mu^{4-D} \lambda : \psi \psi : \psi^- \psi^-, \quad (4.59)$$

$$\mathcal{L}_{ct} = (Z_\psi - 1)(\partial_\mu \psi)^2 + \delta M^2 \psi^2 + \mu^{4-D} \delta g \psi : \phi \phi : \psi + \mu^{4-D} \delta \lambda : \psi \psi : \psi^- \psi^-, \quad (4.60)$$

$$F_n(x_1, \dots, x_n; m, M, g, \lambda, \mu) = \langle 0 | \psi(x_1) \phi(x_2) \dots \phi(x_{n-1}) \psi(x_n) (1 + \int d^D x (\mathcal{L}_{int} + \mathcal{L}_{ct}))^{-1} | 0 \rangle. \quad (4.61)$$

Now we can include the wave function renormalization  $Z_\psi - 1$  in the rescaling of the field  $\psi$  and the renormalized correlations functions up to the renormalization factor are equal to unrenormalized correlation functions in the theory with bare parameters,

$$F_n(x_1, \dots, x_n; m, M, g, \lambda, \mu) = Z_\psi^{-1} F_n^{unren}(x_1, \dots, x_n; m, M_0, g_0, \lambda_0) = Z_\psi^{-1} \langle 0 | \psi(x_1) \phi(x_2) \dots \phi(x_{n-1}) \psi(x_n) \frac{1}{1 + \int d^D x \mathcal{L}_{int}(m, M_0, g_0, \lambda_0)} | 0 \rangle, \quad (4.62)$$

where

$$M_0 = Z_\psi^{-1}(M^2 + \delta M^2), \quad g_0 = Z_\psi^{-1} \mu^{4-D}(g + \delta g), \quad \lambda_0 = Z_\psi^{-2} \mu^{4-D}(\lambda + \delta \lambda). \quad (4.63)$$

It is evident that the renormalized correlations functions being multiplied on  $Z_\psi$  do not depend on  $\mu$  since  $F_n^{unren}$  depends only on bare parameters  $M_0, g_0$  and  $\lambda_0$  which do not depend on the scale parameter specifying the renormalization prescription. This implies the following renormalization group equation

$$\left( \mu \frac{\partial}{\partial \mu} + \beta_g \frac{\partial}{\partial g} + \beta_\lambda \frac{\partial}{\partial \lambda} - \gamma_M \frac{\partial}{\partial \ln M^2} + \gamma \right) F_n(x_1, \dots, x_n; m, M, g, \lambda, \mu) = 0, \quad (4.64)$$

where

$$\beta_g = \mu \frac{\partial g(\mu)}{\partial \mu}, \quad \beta_\lambda = \mu \frac{\partial \lambda(\mu)}{\partial \mu}, \quad \gamma_M = -\frac{\mu}{M^2} \frac{\partial M^2(\mu)}{\partial \mu}, \quad \gamma = \mu \frac{\partial \ln Z_\psi(\mu)}{\partial \mu}. \quad (4.65)$$

The difference between (4.64) and the usual renormalization group equation is that the anomalous dimension  $\gamma$  in (4.64) is not multiplied on  $n/2$ . There is also a difference in the expression of the  $\beta$  and  $\gamma$  functions in terms of the counterterms  $\delta c$  and  $\delta g$ . In dimensional regularization the counterterms are poles in  $(D - 4)$

$$Z_\psi = 1 + \sum_{i=1}^{\infty} \frac{c_i(g, \lambda)}{(4 - D)^i}, \quad \delta g = \sum_{i=1}^{\infty} \frac{a_i(g, \lambda)}{(4 - D)^i}, \quad \delta \lambda = \sum_{i=1}^{\infty} \frac{b_i(g, \lambda)}{(4 - D)^i}. \quad (4.66)$$

As in the usual case one can get the low-order expression for the  $\beta$ -function in terms of  $c_1$  and  $a_1$ . The difference with the usual case comes from the fact that now there is a new expression for  $g_0$  in terms of  $\delta g$  and  $Z_\psi$ . We have

$$g_0 = \mu^{4-D}(g + \delta g) Z_\psi^{-1}, \quad \lambda_0 = \mu^{4-D}(\lambda + \delta \lambda) Z_\psi^{-2}. \quad (4.67)$$

Substituting (4.66) in (4.67) gives

$$\begin{aligned} g_0 &= \mu^{4-D} \left[ g + \frac{a_1(g, \lambda) - g c_1(g, \lambda)}{4-D} + \text{poles of order more than 2} \right], \\ \lambda_0 &= \mu^{4-D} \left[ \lambda + \frac{b_1(g, \lambda) - \lambda c_1(g, \lambda)}{4-D} + \text{poles of order more than 2} \right]. \end{aligned} \quad (4.68)$$

Applying  $\mu \frac{d}{d\mu}$  to both sides of (4.68) yields

$$\begin{aligned} \beta_g(g) &= \left( 1 - \frac{\partial}{\partial \ln g} \right) (g c_1(g, \lambda) - a_1(g, \lambda)), \\ \beta_\lambda(\lambda) &= \left( 1 - \frac{\partial}{\partial \ln \lambda} \right) (2\lambda c_1(g, \lambda) - b_1(g, \lambda)). \end{aligned} \quad (4.69)$$

Taking into account the explicit form of  $c_1(g, \lambda)$ ,  $a_1(g, \lambda)$  and  $b_1(g, \lambda)$  we get

$$\beta_g(g, \lambda) = \frac{g^2}{8\pi^2} + \frac{g^3}{(16\pi^2)^2} + O(g^4, \lambda^4), \quad \beta_\lambda(g, \lambda) = \frac{\lambda^2}{8\pi^2} + O(g^4, \lambda^4). \quad (4.70)$$

We see that the sign of the half-planar beta function  $\beta_g$  is the same as the sign of the standard beta function in  $\varphi^4$  theory but there is a numerical difference of the half-planar beta function with the standard beta function.

A non-standard wave function renormalization in the Boltzmann theory (4.40) implies that a dependence of the renormalized correlation function on the scale parameter  $\mu$  is given by the formula

$$\begin{aligned} F_n(x_1, \dots, x_n; m, M(\mu), g(\mu), \lambda(\mu), \mu) &= \exp\left[-\int_{\mu'}^{\mu} \frac{d\mu''}{\mu''} \gamma(g(\mu''), \lambda(\mu''))\right] \times \\ &F_n(x_1, \dots, x_n; m, M(\mu''), g(\mu''), \lambda(\mu''), \mu''). \end{aligned} \quad (4.71)$$

Since due to a special form of  $\lambda$ -interaction  $\lambda$ -vertices contribute only in the mass renormalization of  $\psi$ -lines and it is natural to expect that the dependence on  $\lambda$  in the high-energy asymptotic of correlation functions may be neglected together with dependence on  $M(\mu)$  and one get the following asymptotic formula

$$F_n(\kappa x_1, \dots, \kappa x_n; m, M(\mu), g(\mu), \lambda(\mu), \mu) \sim \kappa^d \xi^{-1}(\kappa \mu) F_n(x_1, \dots, x_n; 0, 0, g(\mu), 0, \mu), \quad (4.72)$$

for  $\kappa \rightarrow 0$ . Here  $d$  is a dimension of correlation function and

$$\xi^{-1}(\kappa \mu) = \exp\left[-\int_{\mu'}^{\mu} \frac{d\mu''}{\mu''} \gamma(g(\mu''), 0)\right]. \quad (4.73)$$

## ACKNOWLEDGMENT

Both authors are supported by RFFR grant 96-01-00608. We are grateful to G.E.Aru-tyunov, P.B.Medvedev and I.V.Volovich for useful discussions.

## APPENDIX

# A A Note on the Combinatoric of Planar Graphs of a Matrix Model

In this Appendix we prove the following statement. The planar correlation functions without vacuum insertions in all orders of perturbation theory are represented by the sum of all topologically non-equivalent graphs without any combinatoric factors.

The proof of this statement follows from the following considerations. Let us consider an arbitrary planar graph with  $n$  external lines and with  $m$  four-point vertices. We will consider the external lines of graph corresponding to global invariant Green functions as the lines corresponding to an  $n$ -point generalized vertex. We suppose that  $k_1$  from  $m$  four-point vertices are connected with the generalized vertex at least by one line (see Fig. 16, where all double lines are drawn by single lines for simplicity).

The combinatoric factor associated with all possible contractions of  $k_1$  vertices with the  $n$ -point generalized vertex is equal to

$$\frac{m!}{(m - k_1)!} 4^{k_1}.$$

Indeed, to produce topologically equivalent graphs  $k_1$  vertices can be chosen from  $m$  vertices by  $\frac{m!}{(m - k_1)! k_1!}$  ways,  $k_1$  vertices can be permuted by  $k_1!$  ways and each vertex can be attached to the generalized vertex by 4 ways.

After connecting the generalized vertex by lines with  $k_1$  vertices we get the graph which can be considered as some set of generalized vertices which are connected with  $m - k_1$  remaining four-point vertices. For example, on Fig. 16 there are at least two new generalized vertices. They are formed by lines outcoming from 4-vertices labeled by 1, 2, 3, 6, ... and 4, 5. Let us supposed that there are  $r$  new generalized vertices and that  $k_2$  from  $m - k_1$  remaining four-point vertices are connected with new generalized vertices at least by one line so that the first generalized vertex is connected with  $k_2^{(1)}$  4-vertices, the second generalized vertex is connected with  $k_2^{(2)}$  4-vertices and so on. There are

$$\frac{(m - k_1)!}{(m - k_1 - k_2)! k_2!} 4^{k_2} \frac{k_2!}{k_2^{(1)}! \dots k_2^{(r)}!} k_2^{(1)}! \dots k_2^{(r)}! = \frac{(m - k_1)!}{(m - k_1 - k_2)!} 4^{k_2}$$

possibilities to do this. Again we get the graph that can be considered as some set of generalized vertices which are connected in some way with  $m - k_1 - k_2$  remaining four-point vertices.

Analyzing the construction of a full graph by steps that consist in attaching some vertices to generalized vertices and assuming that it is need to do  $l$  steps to get the graph one gets that the total combinatoric factor will be equal to

$$\frac{m!}{(m - k_1)!} 4^{k_1} \frac{(m - k_1)!}{(m - k_1 - k_2)!} 4^{k_2} \dots \frac{(m - k_1 - k_2 - \dots - k_{l-1})!}{(m - k_1 - k_2 - \dots - k_l)!} 4^{k_l} = m! 4^m.$$

This factor is just canceled by the factor  $1/(m! 4^m)$  appearing from the expansion of the exponent of the interaction Lagrangian, that gives the prove of the statement.

## References

- [1] G.'t Hooft, Nucl.Phys. B72 (1974) 461.

- [2] G.Veneziano, Nucl.Phys. B160 (1979) 247.
- [3] E.Witten, in: "Recent Developments in Gauge Theories", eds. G.'tHooft et al. Plenum Press, New York and London (1980)
- [4] I.Ya. Aref'eva and A.A.Slavnov, Lectures in the XIV International School of Young Scientists, Dubna,1980; A.A.Slavnov, Acta Physica Austriaca, Suppl.XXV (1983) 357.
- [5] O. Haan, Z. Physik C6 (1980) 345.
- [6] M.B.Halpern and Schwartz, Phys.Rev. D24 (1981) 2146.
- [7] P.Cvitanovic, Phys.Lett. 99B(1981)49;  
P.Cvitanovic, P.G.Lauwers and P.N.Scharbach, Nucl.Phys. B203 (1982)385.
- [8] I.Ya. Aref'eva, Phys. Lett. 104B (1981) 453.
- [9] Yu. Makeenko and A. A. Migdal, Nucl. Phys. B188 (1981) 269
- [10] A. A. Migdal, Phys. Rep. 102 (1983) 199.
- [11] A.Jevicki and H.Levine, Ann.Phys. 13 (1981) 61.
- [12] A.A.Slavnov, Phys. Lett., 112B (1982) 154.
- [13] I.Aref'eva, Phys.Lett. 124B (1982) 221.
- [14] T.Eguchi and H.Kawai, Phys. Rev. Lett. 48 (1982) 1063.
- [15] G.Parisi, Phys. Lett. 112B (1982) 463.
- [16] D.J.Gross and Y.Kitazawa, Nucl. Phys. B206 (1982) 440.
- [17] J.Greensite and M.B.Halpern, Nucl. Phys. B211 (1983) 343.
- [18] M.Douglas, hep-th-9409098.
- [19] R.Gopakumar and D.Gross, Nucl. Phys. B451 (1995) 379.
- [20] M.Douglas, Phys. Lett. 344B (1995) 117.
- [21] D.Voiculescu, K.J.Dykema, A.Nica *Free random variables*, CRM Monograph Series, Vol. 1, American Math. Soc. (1992).
- [22] D.Voiculescu, Invent. Math., 104 (1991) 201.
- [23] I.Singer, Talk at the Congress of Mathematical Physics, Paris (1994).
- [24] I.Aref'eva and I.Volovich, Nucl. Phys. B462 (1996) 600.
- [25] O.W.Greenberg, Phys.Rev.D43 (1991) 4111.
- [26] L.Accardi, I.Ya.Aref'eva and I.V.Volovich, hep-th-9502092.

- [27] I.Aref'eva and A.Zubarev, Nucl. Phys. B (Proc. Suppl.) 49 (1996) 161.
- [28] I.Aref'eva, hep-th-9601022.
- [29] G.Ferretti, Nucl. Phys. B450 (1995) 713; Preprint UUITP-14/96, hep-th-9607072.
- [30] I.Ya.Aref'eva and A.P.Zubarev, hep-th-9605005 (to appear in Phys. Lett. B).
- [31] M.Douglas and M.Li, Phys. Lett. 348B (1995) 360.
- [32] K.Rothe, Nucl.Phys. B104 (1976) 344.
- [33] N.N.Bogoliubov and D.V.Shirkov, *Introduction to the theory of quantized fields*. New York: Interscience 1959.
- [34] E.Brezin, C.Itzykson, G.Parisi and J.-B. Zuber, Comm. Math. Phys. 59 (1978) 35.
- [35] J.Koplic. A.Neveu and S.Nussimov, Nucl. Phys. B123 (1977) 109.
- [36] L. Accardi, I.Ya.Aref'eva, S.V. Kozyrev and I.V.Volovich, Mod. Phys. Lett. A10 (1995) 2323.
- [37] M.B.Halpern and C.Schwartz, Phys.Rev.D24 (1981) 2146.

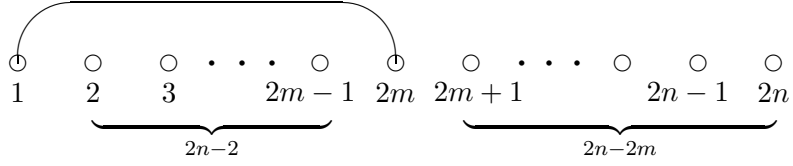

Figure 1: Derivation of the Schwinger-Dyson equations for free Green's functions in the Boltzmannian Fock space.

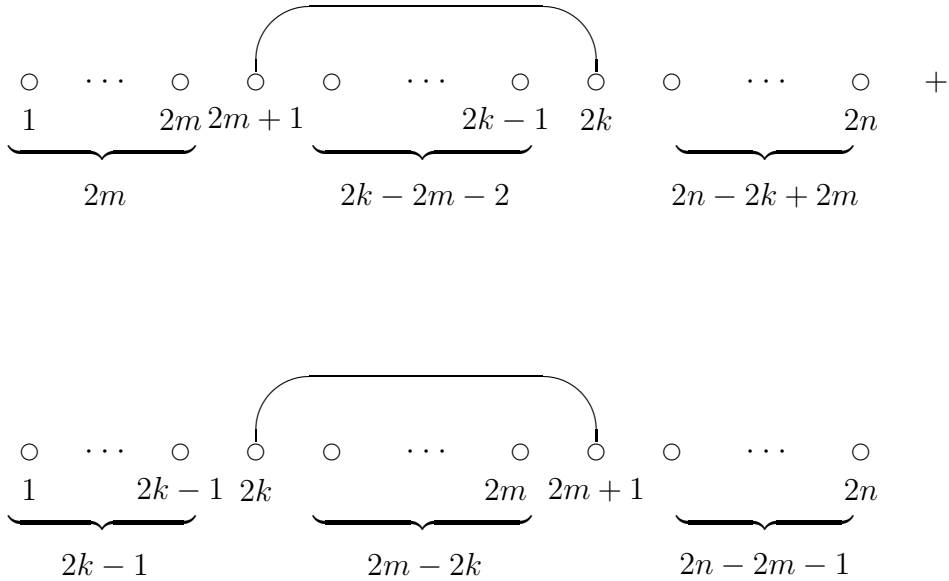

Figure 2: Derivation of the Schwinger-Dyson equations for free Green's functions in the Boltzmannian Fock space (the  $2k$ -th marked operator).

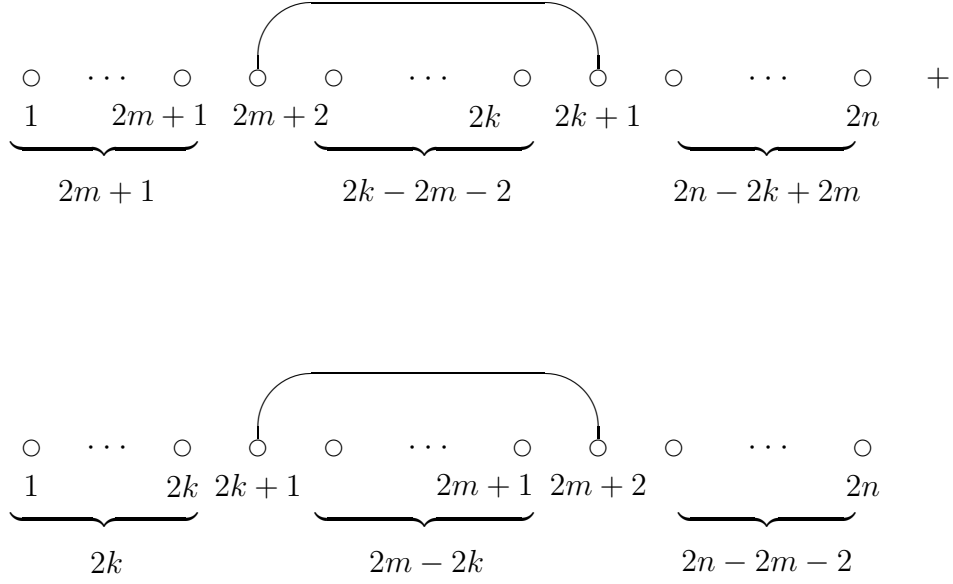

Figure 3: Derivation of the Schwinger-Dyson equations for free Green's functions in the Boltzmannian Fock space (the  $2k + 1$ -th marked operator).

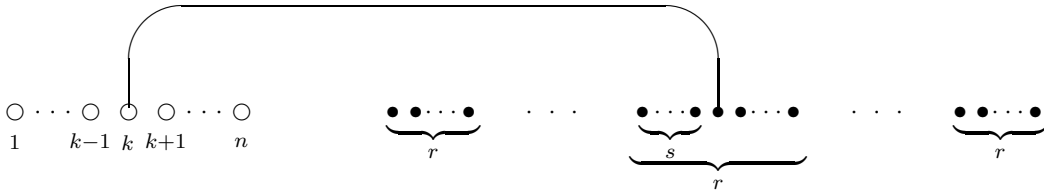

Figure 4: Derivation of the Schwinger-Dyson equations in the Boltzmannian Fock space for the interaction  $\phi^r$ .

$g$	$g^2$	$g^3$	
		8	8
		16	8

Figure 5: Planar graphs in the matrix theory with the quartic interaction up to order  $g^3$ .



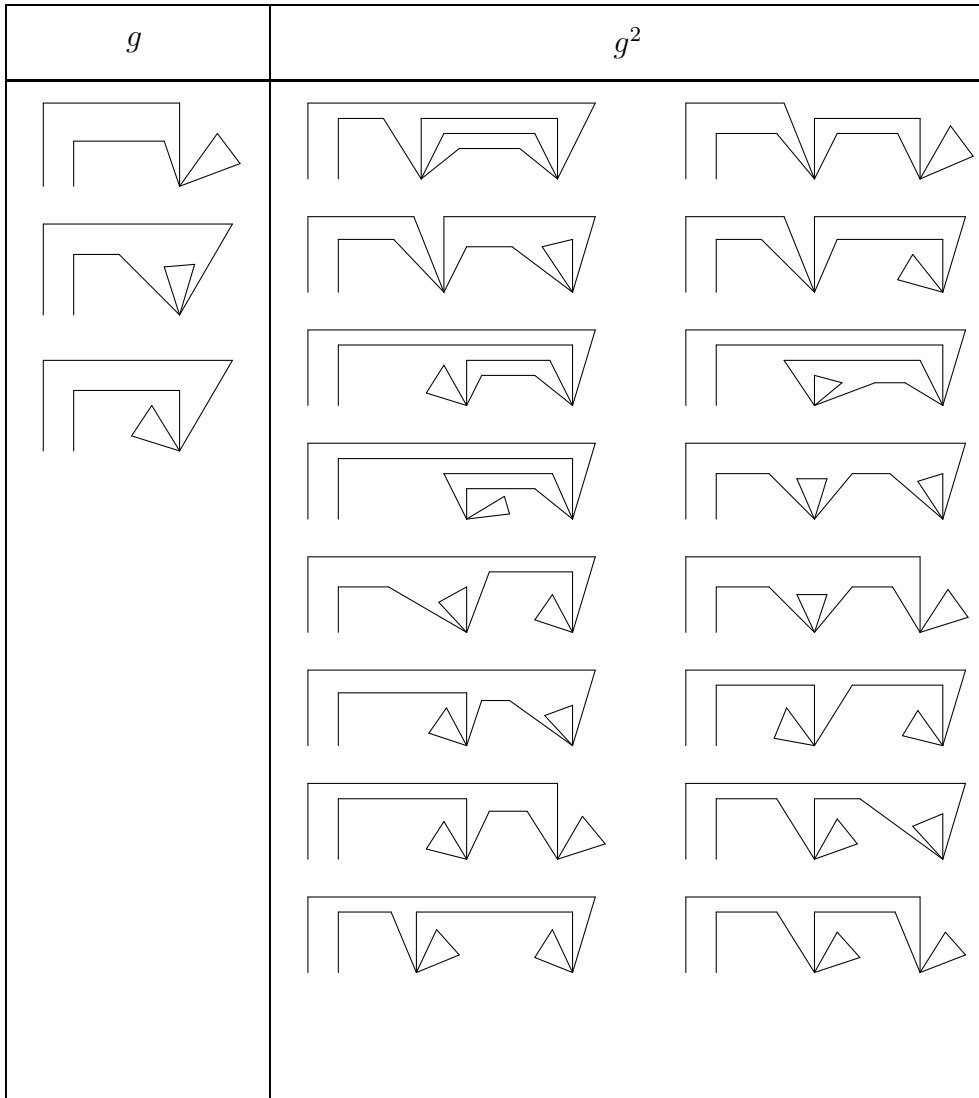

Figure 6: Half-planar graphs in the Boltzmann theory with the quartic interaction up to order  $g^2$ .

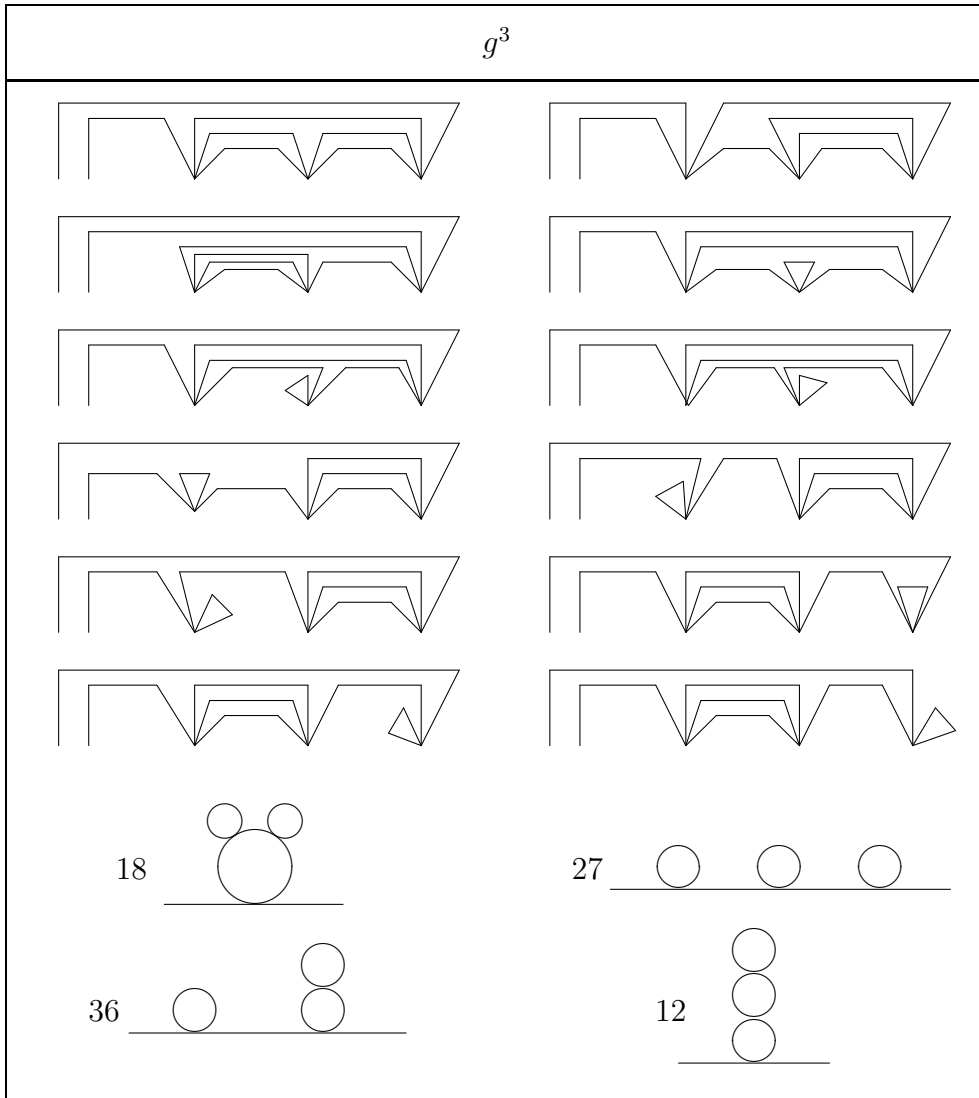

Figure 7: Half-planar graphs in the Boltzmann theory with the quartic interaction in the order  $g^3$ .

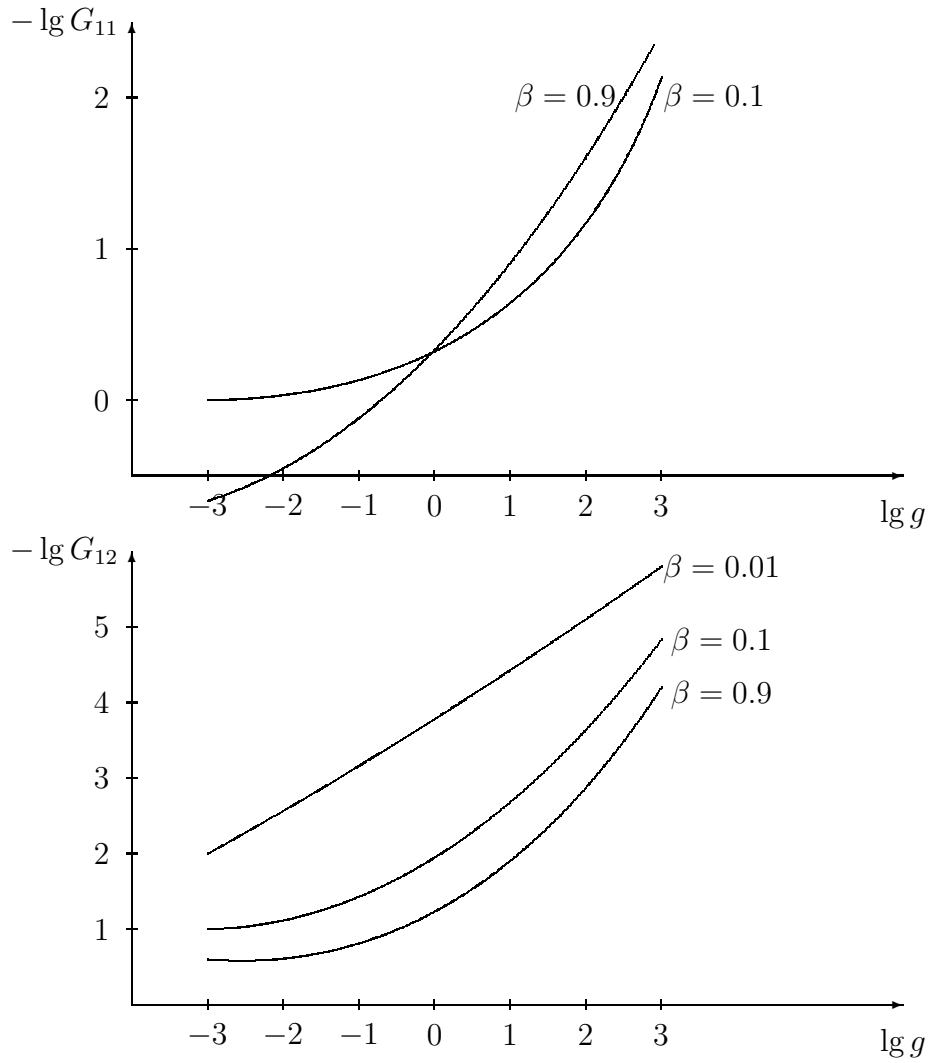

Figure 8: The dependences of the two-point Green's functions  $G_{11}$  and  $G_{12}$  on the coupling constant  $g$  for different values of  $\beta$ .

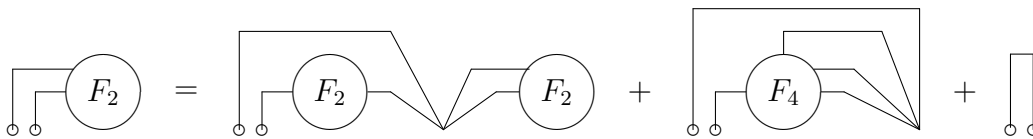

Figure 9: Graphical representation of equation (4.21).

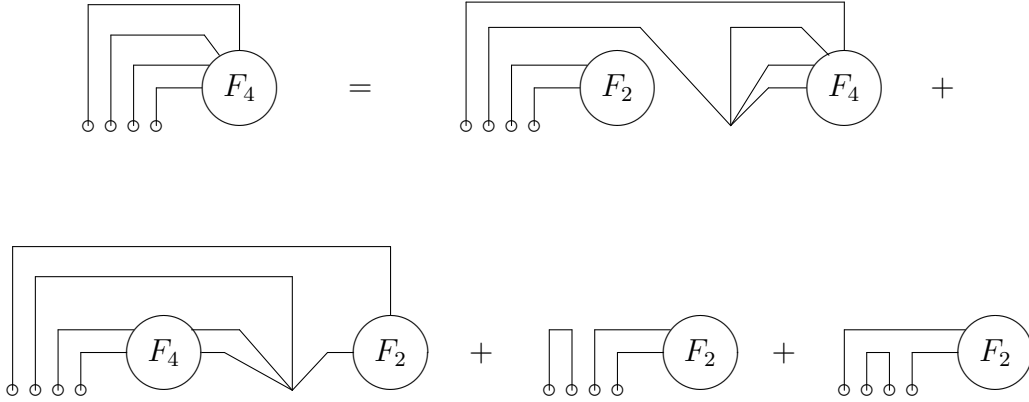

Figure 10: Graphical representation of equation (4.20).

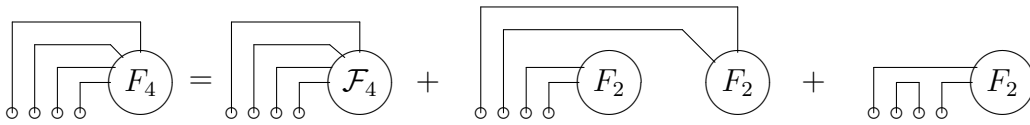

Figure 11: Graphical representation of equation (4.23).

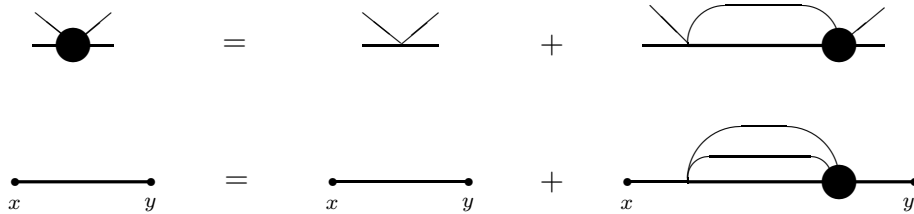

Figure 12: Graphical representation of equations (4.29) and (4.30)

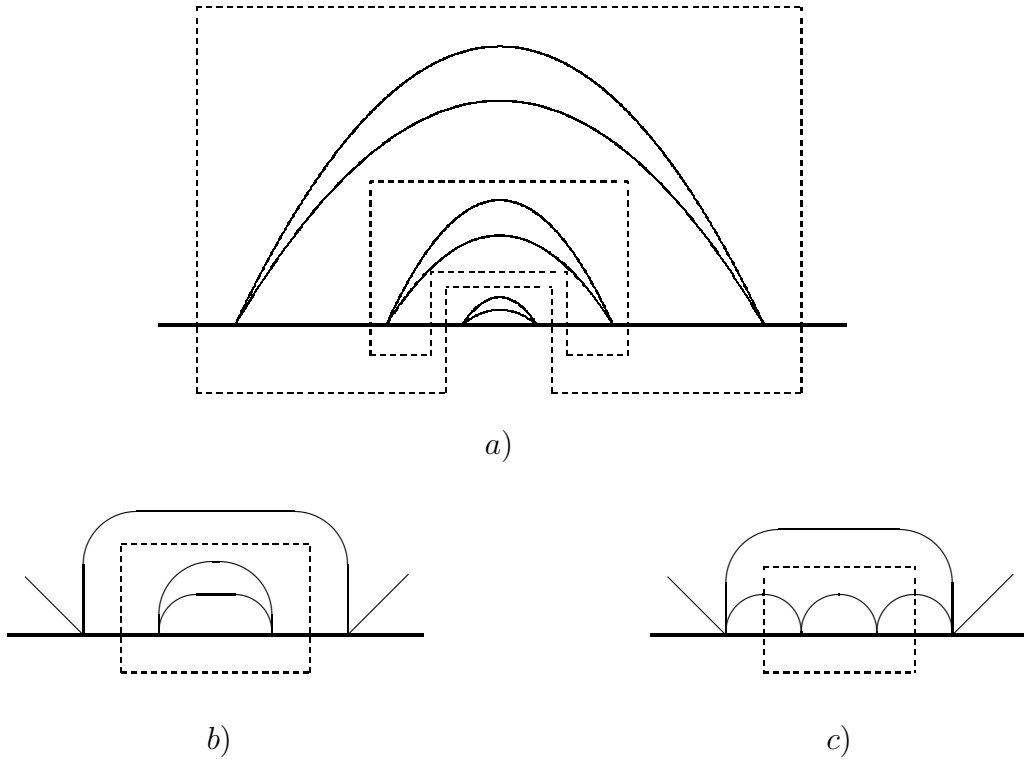

Figure 13: a) Example of divergent parts of  $\Pi$ -type of the two-point half-planar graph.  
 b), c) Examples of half-planar divergent subgraphs.

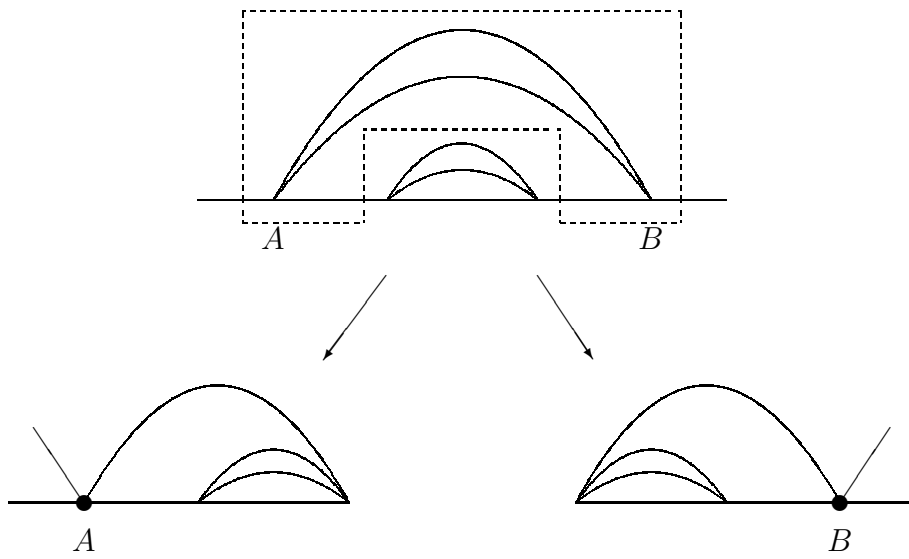

Figure 14: Two possibilities making a contraction of  $\Pi$ -type subgraph to a point.

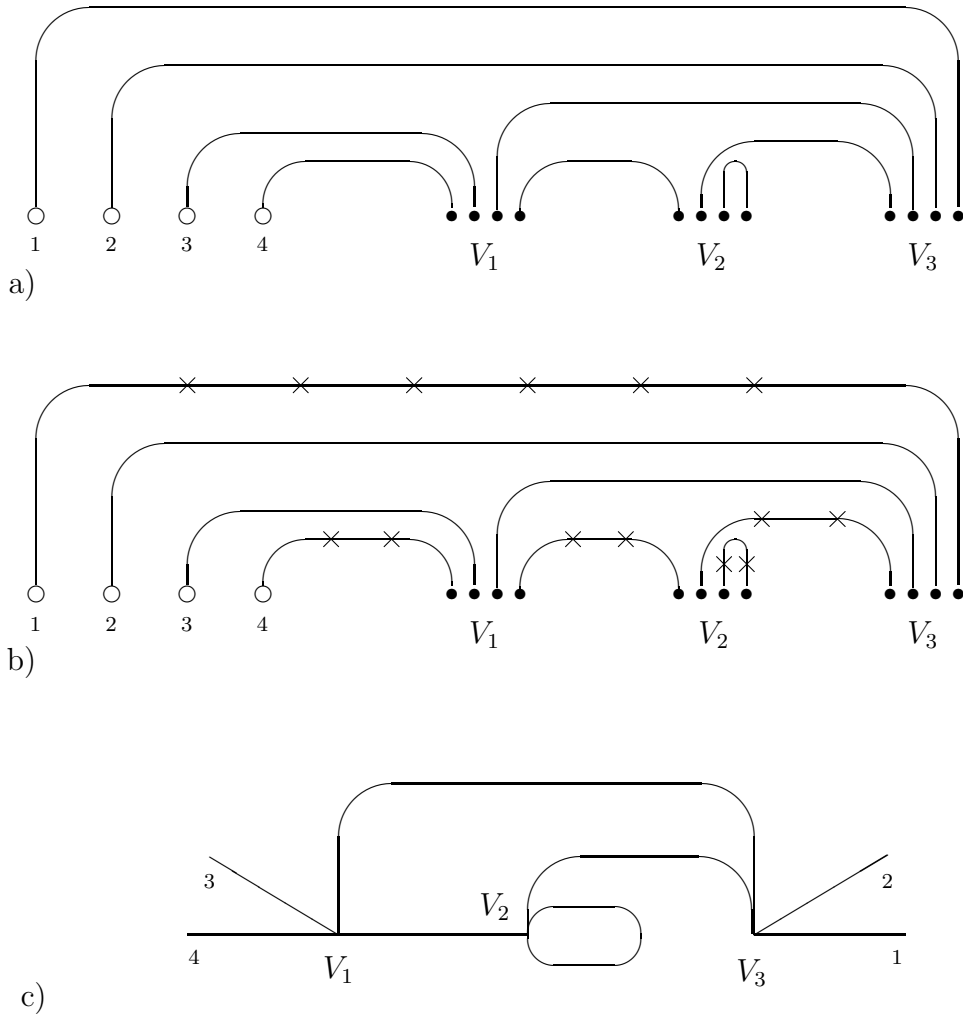

Figure 15: Graph for 4-point correlation function in the Boltzman field theory. Some lines of graph a) are marked by crosses. Insertions of  $\delta M^2 \phi^2$  and  $(Z_\psi - 1)(\partial_\mu \phi)^2$  are admissible only on the marked lines.

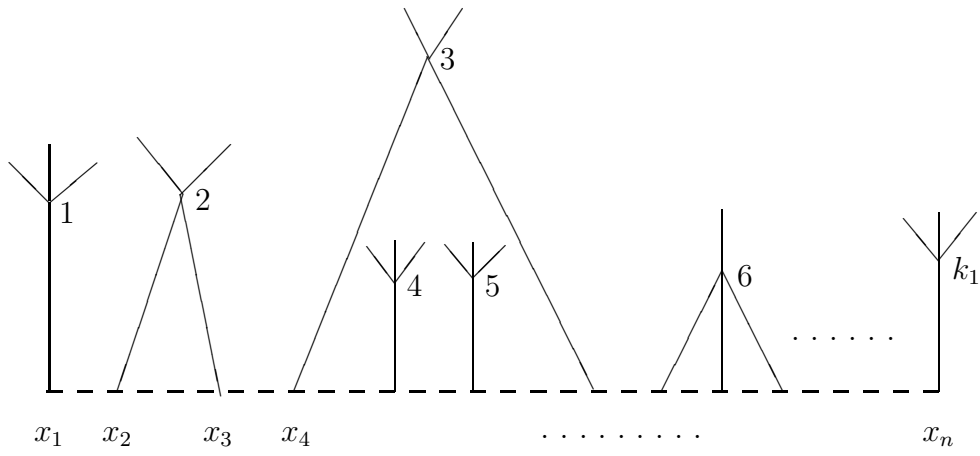

Figure 16: Construction of planar graph.  $k_1$  of  $m$  four-point vertices are connected with the generalized vertex at least by one line. Two new generalized vertices are formed by lines outcoming from 4-vertices labeled by 1, 2, 3, 6, ... and 4, 5.