

# GORENSTEIN-FANO GENERIC TORUS ORBITS IN $G/P$

PIERRE-LOUIS MONTAGARD AND ALVARO RITTATORE

ABSTRACT. Given a simple algebraic group  $G$  and a parabolic subgroup  $P \subset G$ , with maximal torus  $T$ , we consider the closure  $X$  of a generic  $T$ -orbit (in the sense of Dabrowski’s work) in  $G/P$ , and determine when  $X$  is a Gorenstein-Fano variety. We deduce of this classification a list of some pairs of dual reflexive polytopes.

## 1. INTRODUCTION

If  $\Lambda$  is a lattice and  $\Lambda_{\mathbb{Q}}$  the  $\mathbb{Q}$ -vector generated by  $\Lambda$ , a fan  $\Sigma$  is a finite set, stable by taking intersection and face, of polyhedral, strictly convex, lattice cones in  $\Lambda_{\mathbb{Q}}$ . The theory of toric varieties associates to fans  $\Sigma$ , normal varieties  $X_{\Sigma}$  on which an algebraic torus  $T$  acts effectively and with an open orbit. Lattices and fans come naturally in the theory of root systems and from the early beginning of the theory of toric varieties, Mumford in [Kempf73] associated for each root system  $R$  the fan defined by the set of all closed Weyl chambers, relatively to the weight lattice. These varieties were studied a lot: for example in [Pro90], [DL94] or more recently in [BaB11].

In [VoKl85], V.E. Voskresenskiĭ and A.A. Klyachko considered a larger family of fans constructed by “gluing together” selected adjacent Weyl chambers. Let’s formalize their construction. To a choice of a set of simple roots in a root system  $R$  corresponds a set of reflections  $\{s_i : i \in I\}$  which generates  $W$  the Weyl group of  $R$ . For each  $L \subset I$ , let’s define  $W_L$  the subgroup of  $W$  generated by  $\{s_i : i \in L\}$ , then we can consider the set  $\sigma_{R,L}$  as the union of  $w\mathcal{D}^{\vee}$  for  $w \in W_L$  and  $\mathcal{D}^{\vee}$  the dominant Weyl chamber of the dual root system  $R^{\vee}$ . If  $L \neq I$  and  $R$  irreducible,  $\sigma_{R,L}$  is a strictly convex polyhedral lattice cone. We can define the fan  $\Sigma_{R,L}$  such that its cones of maximal dimension are the translate of  $-\sigma_{R,L}$  by elements  $w$  in the whole group  $W$  (see 3.2 for a precise definition). The variety associated to this fan was denoted by  $X_{R,L}$ . Note that we recover the original construction of Mumford by considering  $L = \emptyset$ .

The fact that we consider  $\mathcal{D}^{\vee}$  in place of the dominant Weyl chamber of  $R$  can be justified by the following: to each couple  $(R, L)$ , we can also associate a generalized flag variety which is an homogeneous space  $G/P$  where  $G$  is a simple group of root system  $R$  and  $P$  is a parabolic group containing a fixed maximal torus  $T$  of  $G$  and of Weyl group  $W_L$ . In this context, R. Dabrowski in [Dab96] define a fine notion of a “generic  $T$ -orbit in  $G/P$ ”. The remarkable result of this work is that the closure of a generic orbit is a normal variety, so this variety is toric and its associated fan is  $\Sigma_{R,L}$ .

In [VoKl85], V.E. Voskresenskiĭ and A.A. Klyachko considered only couples  $(R, L)$  such that varieties  $X_{R,L}$  were smooth, and among these varieties they gave

the list of the ones which are Fano, that is such that the anticanonical bundle  $-K_X$  is ample. The notion of  $\mathbb{Q}$ -Gorenstein Fano variety is a natural generalization of the notion of Fano variety. More precisely, if  $X$  is a normal variety, the anticanonical bundle does not necessarily exist, but we can define an anticanonical divisor  $-K_X$ . We say that  $X$  is  $\mathbb{Q}$ -Gorenstein Fano, if there exists an integer  $m$  such that  $m(-K_X)$  is an ample Cartier divisor, and Gorenstein Fano if we can take  $m = 1$ . In this work, we give the list of closures of generic  $T$ -orbits in  $G/P$  (or in an equivalent way, of varieties  $X_{R,L}$ ) which are  $\mathbb{Q}$ -Gorenstein Fano or Gorenstein Fano. Of course the list of V.E. Voskresenskii and A.A. Klyachko is included in our list. In a way, this inclusion is wide: in the smooth case, it appears only irreducible root systems of type  $A_n, C_n, G_2$  and the Fano Varieties forms three infinite series plus one exceptional case. By releasing the smooth constraint, we obtain varieties  $X_{R,L}$  which is  $\mathbb{Q}$ -Gorenstein Fano for all types of irreducible root systems except  $E_7$  and  $E_8$ , and the  $\mathbb{Q}$ -Gorenstein Fano varieties form twelve infinite series plus five exceptional cases.

It is well-known that Gorenstein Fano toric varieties are in correspondence with reflexive polytopes. As a by product of our work, we obtain a list of some pairs of dual reflexive polytopes. These pairs are as follow: in right hand, the polytope defined by the convex hull of  $\text{Prim}(\Sigma_{R,L})$  (see section 2.1 for definition) defined relatively to the weight lattice of  $R^\vee$ , in left hand convex hull of an orbit of  $W$  (*i.e.* a Weyl polytope) relatively to the root lattice of  $R$ .

We describe now the content of this paper.

In Section 2 we collect some basic facts on toric varieties and their associated fans, and we introduce the notion of Gorenstein Fano varieties in the toric context. In section 3, we present our notations for root systems, and we detail the construction of fans  $\Sigma_{R,L}$ . Then we explain the work of Dabrowski [Dab96] which make a link between these fans and the closure of the generic orbits.

In the section 4, we study combinatorial properties of the cone  $\sigma_{R,L}$ . This study permits to characterize the  $\mathbb{Q}$ -Gorenstein-Fano generic closures in theorem 4.14: a generic closure associated to a subset  $L \subset I$  is  $\mathbb{Q}$ -Gorenstein-Fano if and only if the convex hull of  $\text{Prim}(\sigma_{R,L})$  (the primitive vectors of the cone  $\sigma_{R,L}$ ) is a  $(n-1)$ -dimensional polytope, such that the normal of its support hyperplane is interior to the cone generated by  $\{\omega_i : i \in I \setminus L\}$ . In the section 5.1 we give a list of variety  $X_{R,L}$  which are ( $\mathbb{Q}$ -)Gorenstein Fano for  $R$  irreducible roots system. In section 6, by using results in the section 4, we give the proof of the classification.

Finally in the last section 8, we explicit pair of dual reflexive polytopes associated to each Gorenstein Variety  $X_{R,L}$ .

In a previous version of this paper, calculations for groups of exceptional type  $E_6, E_7, E_8, F_4$  were made by using the following softwares: Sage [St] and the version of Gap3 [Sch97] maintained by Jean Michel — that allow us to use the package Chevie (see [GHLMP96] and [Mic2015]). In this regard, we warmly thank Cédric Bonnafé for his short, but effective introduction to Gap3. Although this program is no longer necessary to prove our result, writing and using it allowed us to better understand the cone  $\sigma_{R,L}$ . Interested readers can download this program online (see [MR17]).

*Acknowledgments:* the authors thank the Instituto Franco-Uruguayo de Matemática (Uruguay), MathAmSud Project RepHomol, CSIC (Udelar, Uruguay) and the Institut Montpelliérain Alexander Grothendieck (France) for partial financial support.

## 2. PRELIMINARIES

**2.1. Toric varieties.** Our general reference for toric varieties is the book of Cox, Little and Schenck [CLS11]. Let  $T$  be an algebraic torus. We denote by  $\Lambda$  the characters group of  $T$  which is a  $\mathbb{Z}$ -lattice. We denote by  $\Lambda^\vee$  its  $\mathbb{Z}$ -dual and by  $\Lambda_{\mathbb{Q}}$  (resp.  $\Lambda_{\mathbb{Q}}^\vee$ ) the  $\mathbb{Q}$ -vector space  $\mathbb{Q} \otimes_{\mathbb{Z}} \Lambda$  (resp.  $\mathbb{Q} \otimes_{\mathbb{Z}} \Lambda^\vee$ ). For  $(u, v) \in \Lambda_{\mathbb{Q}} \times \Lambda_{\mathbb{Q}}^\vee$  we denote by  $\langle u, v \rangle$  the natural pairing.

If  $X$  is a subset of a  $\mathbb{Q}$ -finite dimensional vector space  $V$ , we denote by  $\text{Conv } X$  the convex hull of  $X$ , by  $\langle X \rangle$  the vector space generated by  $X$ , by  $\langle X \rangle_{\text{aff}}$  the affine space generated by  $X$  and by  $\mathbb{Q}^+ X$  the positive cone generated by  $X$ . We denote also by  $X^* \subset V^\vee$  the "positive dual" of  $X$ , that is:

$$X^* = \{\varphi \in V^\vee : \forall x \in X, \langle x, \varphi \rangle \geq 0\}$$

Now, we define toric variety.

**Definition 2.1.** Let  $T$  be an algebraic torus. A  $(T)$ -toric variety  $X$  is a normal variety with an effective action of  $T$  and such that  $T$  has an open orbit in  $X$ .

The theory of toric varieties is based on a correspondence between combinatorial objects called fans and some algebraic varieties.

**Definition 2.2.** A fan  $\Sigma$  is a finite collection of rational polyhedral, strictly convex cones in  $\Lambda_{\mathbb{Q}}^\vee$  such that:

- (i) if  $\sigma \in \Sigma$  and  $\tau$  is a face of  $\sigma$ , then  $\tau \in \Sigma$ ;
- (ii) for every  $\sigma, \tau \in \Sigma$ ,  $\sigma \cap \tau$  is a common face of  $\sigma$  and  $\tau$ .

If  $\Sigma$  is a fan, we denote  $X_\Sigma$  the associated toric variety. Here are some basic properties of toric varieties that we use in the sequel.

**Proposition 2.3.** *The variety  $X_\Sigma$  is smooth if and only if for each  $\sigma \in \Sigma$ ,  $\sigma$  is generated by family in  $\Lambda^\vee$  which can be completed in a basis of  $\Lambda^\vee$ .*

*The variety  $X_\Sigma$  is complete if and only if  $\Sigma$  is complete i.e.  $\bigcup_{\sigma \in \Sigma} \sigma = (\Lambda^\vee)_{\mathbb{Q}}$*

Other classic result: let's denote by  $\Sigma(r)$  the set of cone  $\sigma \in \Sigma$  of dimension  $r$ ; the set  $\Sigma(r)$  correspond to closed  $T$ -variety of co-dimension  $r$ , and the  $T$ -stable Weil divisors are in one-to-one correspondence with the  $\mathbb{Z}$ -linear combinations  $\sum_{\sigma \in \Sigma(1)} a_\rho D_\rho$ , where  $a_\rho \in \mathbb{Z}$  and  $D_\rho$  is the  $T$ -stable divisor associated to the cone  $\rho \in \Sigma(1)$ .

**2.2. Gorenstein Fano Toric variety.** If  $X$  is a normal variety, then we can define its canonical sheaf and its dual the anti-canonical sheaf. These sheafs are reflexive, we can associate a canonical divisor denoted by  $K_X$  and a anti-canonical divisor  $-K_X$ .

**Definition 2.4.** A normal variety  $X$  is a  $\mathbb{Q}$ -Gorenstein Fano variety (resp. Gorenstein Fano variety) if  $-K_X$  is an ample,  $\mathbb{Q}$ -Cartier divisor (resp. an ample, Cartier divisor). If  $X$  is  $\mathbb{Q}$ -Gorenstein, we denote by  $j_X$  the smallest positive integer such that  $j_X K_X$  is Cartier;  $j_X$  is called the Gorenstein Index of  $X$ . A smooth variety  $X$  is a Fano variety if  $-K_X$  is an ample divisor.

In the case of  $X = X_\Sigma$  is a toric variety associated to the fan  $\Sigma$ , we call  $\Sigma$   $\mathbb{Q}$ -Gorenstein Fano, Gorenstein Fano, Fano if  $X_\Sigma$  has the corresponding property. In toric case, the anti-canonical divisor  $-K_{X_\Sigma}$  has a very simple description. For all  $\rho \in \Sigma(1)$ , we have (see Theorem 8.2.3 of [CLS11]):

$$-K_{X_\Sigma} = \sum_{\rho \in \Sigma(1)} D_\rho.$$

For each  $\rho \in \Sigma(1)$  let  $u_\rho$  be the primitive element of the one dimensional monoid  $\rho \cap \Lambda^\vee$ . For each  $\sigma \in \Sigma$  we denote

$$\text{Prim}(\sigma) = \{u_\rho : \rho \subset \sigma\}$$

and

$$\text{Prim}(\Sigma) = \bigcup_{\sigma \in \Sigma} \text{Prim}(\sigma).$$

By using particular case of [CLS11, Lemma 6.1.13] and [CLS11, Theorem 4.2.8], we deduce the following equivalences:

**Lemma 2.5.** *Let  $\Sigma$  be a complete fan in  $\Lambda_\mathbb{Q}^\vee$ , the following assertions are equivalent:*

- (i)  $\Sigma$  is  $\mathbb{Q}$ -Gorenstein-Fano;
- (ii) the elements of  $\{\text{Conv}(\text{Prim}(\sigma)) : \sigma \in \Sigma(s), s = 1, \dots, n\}$  are the proper faces of the polytope  $\text{Conv}(\text{Prim}(\Sigma))$ ;
- (iii) for every cone  $\sigma \in \Sigma(n)$ , the polytope  $\text{Conv}(\text{Prim}(\sigma))$  is  $(n-1)$ -dimensional; let  $\varphi_\sigma \in \Lambda_\mathbb{Q}$  be such that  $\langle \varphi_\sigma, v \rangle = -1$  for  $v \in \text{Prim}(\sigma)$ . Then  $\langle \varphi_\sigma, w \rangle > -1$  for every  $w \in \text{Prim}(\Sigma) \setminus \text{Prim}(\sigma)$ .

Moreover, a  $\mathbb{Q}$ -Gorenstein-Fano fan  $\Sigma$  is Gorenstein-Fano if and only if  $\langle \varphi_\sigma, u \rangle \in \mathbb{Z}$  for all  $u \in \Lambda^\vee$  and  $\sigma \in \Sigma(n)$ .

### 3. TORIC VARIETY ASSOCIATED TO ROOT SYSTEMS

**3.1. Root systems.** When dealing with root systems, we follow the notations of Bourbaki (see [Bou68], or its English translation [B68en]). In what follows,  $R$  designed a root system of rank  $n$  and  $W$  the associated Weyl group. We denote by  $R^+$  a chosen set of positive roots. This choice define  $\{\alpha_i : i \in I\}$  the set of the simple roots and  $\{\omega_i : i \in I\}$  the set of associated fundamental weights,  $n$  is so equal to  $\#I$  the cardinal of  $I$ . Recall that  $(\alpha_i)_{i \in I}$  is a basis of the root lattice  $\Lambda_\alpha$  and  $(\omega_i)_{i \in I}$  is a basis of the weight lattice  $\Lambda_\omega$ . The rational positive linear combination of fundamental weights  $\{\omega_i : i \in I\}$  generate the dominant Weyl chamber  $\mathcal{D}$  in  $(\Lambda_\omega)_\mathbb{Q}$ ,

We also use the dual root system  $R^\vee$ ; let  $\{\alpha_i^\vee : i \in I\}$  the set of simple root of  $R^\vee$  and we denote by  $(\omega_i^\vee)_{i \in I}$  the set of fundamental weight of  $R^\vee$  (the set of fundamental co-weight of  $R$ ) and by  $\mathcal{D}^\vee$  the dominant Weyl Chamber of  $R^\vee$ . Recall that for all  $(i, j) \in I^2$ , we have  $\langle \alpha_i, \omega_j^\vee \rangle = \delta_{ij}$  and so  $(\omega_i^\vee)_{i \in I}$  is a basis of  $\Lambda_\alpha^\vee$  the

$\mathbb{Z}$ -dual of  $\Lambda_\alpha$ . We denote  $(\Lambda_\alpha)_\mathbb{Q}$  the  $\mathbb{Q}$ -vector space  $(\Lambda_\alpha) \otimes_{\mathbb{Z}} \mathbb{Q}$  and by  $(\Lambda_\alpha^\vee)_\mathbb{Q}$  its dual space.

Finally we choose in  $(\Lambda_\omega)_\mathbb{Q}$  and in  $(\Lambda_\omega)^\vee_\mathbb{Q}$  a scalar product  $W$ -invariant; this scalar product will be denoted by  $(\cdot, \cdot)$  in the two cases.

**Remark 3.1.** If the root system is *simply laced*, we can choose a scalar product such that  $(\alpha, \alpha) = (\alpha^\vee, \alpha^\vee) = 2$  for all roots. This scalar product gives an isomorphism between  $R$  and  $R^\vee$  and permits also to identify  $\Lambda_\alpha^\vee$  with  $\Lambda_\omega$ . This identification is not true in general.

Finally if  $\lambda = \sum_{i=1}^n a_i \omega_i \in \Lambda_\omega$  is a weight, we define the *support* of  $\lambda$  as the set  $I_\lambda = \{i : a_i \neq 0\}$ .

**3.2. Fans defined by root systems.** Now we define a fan (and so a toric variety) for a root system  $R$  and a subset of simple root of  $R$ , as follow.

**Definition 3.2.** Let  $R$  be a root system of rank  $n$ , and  $L \subset I$ ; let  $W_L$  be the subgroup of  $W$  generated by the following set  $\{s_{\alpha_i} : i \in L\}$ . We define

$$\sigma_{R,L} = \bigcup_{w \in W_L} w\mathcal{D}^\vee$$

and  $\tilde{\Sigma}_{R,L}$  the translate of  $-\sigma_{R,L}$  by  $W$ :

$$\tilde{\Sigma}_{R,L} = \{-w\sigma_{R,L} : w \in W^L\}$$

where  $W^L \subset W$  is a set-theoretical section of  $W/W_L$ .

To show that under a simple hypothesis, the cone  $\sigma_{R,L}$  is strictly convex, we state a proposition about the dual cone of  $\sigma_{R,L}$ . This easy result appears without proof in the work of Dabrowski [Dab96], we give it for completeness and to have a precise formulation.

**Proposition 3.3.** *Let  $(R^L)^+$  be the set of positive roots which are not sum of simple roots  $\alpha_i$  for  $i \in L$  and  $S^L$  the sub-monoid generated by  $(R^L)^+$ . Then the dual to the convex cone generated by the sub-monoid  $S^L$  is equal to  $\sigma_{R,L}$ , that is to say:*

$$(\mathbb{Q}^+ \cdot (S^L))^* = \sigma_{R,L}.$$

*Proof.* We will show that:

$$((R^L)^+)^* = \sigma_{R,L}.$$

For this, let  $R_L$  be the set of roots which are sum of simple roots in  $\{\alpha_i : i \in L\}$ , then by definition  $(R^L)^+ = R^+ \setminus (R_L \cap R^+)$ , so the two sets  $(R^L)^+$  and  $S^L$  are stable by  $W_L$ . We deduce that  $((R^L)^+)^*$  is stable by  $W_L$  and as it contains the dominant chamber  $\mathcal{D}^\vee$ , we have the inclusion:  $\sigma_{R,L} \subset ((R^L)^+)^*$ .

The set  $((R^L)^+)^*$  is the intersection of half-space of type:

$$\{\chi^\vee \in (\Lambda_\alpha^\vee)_\mathbb{Q} : \langle \beta, \chi^\vee \rangle \geq 0\}$$

with  $\beta$  positive root, so  $((R^L)^+)^*$  is convex and union of Weyl chamber, which conclude the proof.  $\square$

We denote by  $R = \prod_{k=1}^k R_k$  the decomposition of the root system  $R$  in irreducible root systems and we denote by  $I(k)$  the set of simple roots of  $R_k$ .

**Proposition 3.4.** *Suppose that for each  $k = 1, 2, \dots, r$ ,  $L \cap I(k) \neq I(k)$  then  $\sigma(R, L)$  is a strictly convex polyhedral cone.*

*Proof.* By using the proposition 3.3 and classical result on the dual cone, we have essentially to show that the cone  $\mathbb{Q}^+(S^L)$  generates the vector space  $(\Lambda_\alpha^\vee)_\mathbb{Q}$ . If  $R$  is irreducible, it is well-known that if  $L$  is a strict subset of  $I$ , then  $(R^L)^+$  generates a space of maximal dimension. The general case can be deduced directly.  $\square$

**Definition 3.5.** Suppose that the hypothesis of the proposition 3.4 is verified, then the set  $\tilde{\Sigma}_{R,L}$  defined a fan which was denoted by  $\Sigma_{R,L}$ ; this fan and the co-weight lattice  $(\Lambda_\alpha)^\vee$  define a toric variety  $X_{R,L}$ .

**Remark 3.6.** (i) Clearly the fan  $\Sigma_{R,L}$  is a product of the fan  $\Sigma(R_k, L \cap I_k)$  and so the variety  $X_{R,L}$  is a product of  $X(R_k, L \cap I_k)$  for  $k = 1, 2, \dots, r$ . For study the variety  $X_{R,L}$  we can suppose that  $R$  is irreducible.  
(ii) The justification of the minus sign in the definition of  $\Sigma_{R,L}$ , of the choice of the co-weight lattice and of the fact that we define  $\sigma_{R,L}$  in  $(\Lambda_\alpha^\vee)_\mathbb{Q}$  and not in  $(\Lambda_\omega)_\mathbb{Q}$  will be appear now in the following section 3.3.

**3.3. Generic orbits of  $G/P$ , results of Dabrowski.** Let  $G$  be a semi-simple group over  $k$ , let's denote by  $T$  a maximal torus of  $G$ ; let  $R$  be the root system associated to the couple  $(G, T)$ . We choose a Borel subgroup  $B$  of  $G$  which induces a choice of the set of positive roots  $R^+$ . We take the same notation for  $R$  as in the section 3. To each subset  $L$  of  $I$ , let's define the parabolic subgroup  $P$  containing the Borel subgroup  $B^-$  opposite to  $B$  and such that the Weyl group  $W_P$  of  $P$  is equal to  $W_L$ . Let's define  $\bar{L} = I \setminus L$  and let  $\lambda$  be a dominant weight such its support  $I_\lambda$  is equal to  $\bar{L}$ . Then  $\lambda$  can be extended to  $P$ . We denote by  $V(\lambda)$  the Weyl  $G$ -module associated to  $\lambda$  — recall that

$$V(\lambda) = \{f \in \mathbb{k}[G] : f(xy) = \lambda^{-1}(y)f(x) \forall x \in G, y \in P\}.$$

**Definition 3.7** (see [Dab96, §1]). Let  $L, P \supset B^-$  and  $\lambda$  be defined as above.

Let  $\Pi_\lambda = \{\mu \in \Lambda_P : V(\lambda)_\mu \neq 0\}$  the set of  $T$ -weights of  $V(\lambda)$  and  $\mathcal{A}_\lambda$  be the list of the  $T$ -weights counted with multiplicity. A set of Plücker coordinates  $\{f_\mu : \mu \in \mathcal{A}_\lambda\}$  is a choice of a basis of  $T$ -semi-invariants functions  $f_\mu \in V(-\lambda)_\mu$ .

If  $x = uP \in G/P$ , we consider

$$\Pi_\lambda(x) := \{\mu \in \Pi_\lambda : f_\mu(x) \neq 0 \text{ for some } f_\mu \text{ in the Plücker basis}\}.$$

It is easy to see that  $\Pi_\lambda(x)$  does not depends on the choice of the Plücker coordinates. Moreover,  $\lambda - w\Pi_\lambda(x) \subset S^L \subset \Lambda_\alpha$ , for every  $w \in W$ .

We say that the  $T$ -orbit  $T \cdot x$  is *generic* in the sense of Dabrowski if:

- (i)  $W \cdot \lambda \subset \Pi_\lambda(x)$
- (ii) The set  $\lambda - w\Pi_\lambda(x)$  generates  $S^L$  as a sub-monoid.

We recall in the next theorem some of the properties of generic orbits shown on [Dab96], that we need for the rest of this work.

**Theorem 3.8** ([Dab96, Theorem 3.2]). *If  $x \in G/P$  is such that all its Plücker coordinates do not vanish, then  $T \cdot x$  is a generic orbit. In particular, generic orbits exist.*

If  $T \cdot x$  is a generic orbit, then the  $T$ -orbit closure  $\overline{T \cdot x} \subset G/P$  is a toric variety. This toric variety is isomorphic to the variety  $X_{R,L}$  defined by the fan  $\Sigma_{R,L}$ .

**Remark 3.9.** The closure of a generic orbit is a toric variety, but not for the torus  $T$  which doesn't act effectively on  $G/P$ . But if the hypothesis of the proposition 3.4 is verified this closure is a toric variety for the quotient  $T/Z(G)$ . Note that the lattice  $\Lambda_\alpha$  the lattice of characters of this quotient. This explains why the fan  $\Sigma_{R,L}$  is defined in the space  $(\Lambda_\alpha)_\mathbb{Q}^\vee$  and relatively to the lattice  $\Lambda_\alpha^\vee$  (the lattice of co-weights).

In the work of Dabrowski [Dab96] the fan associated to the generic orbit is defined in the space  $(\Lambda_\omega)_\mathbb{Q}$  (relatively to the lattice  $(\Lambda_\omega)$ ); but with this definition, and if the root system is not simply laced, the fan obtained does not correspond to the closure of a generic orbit. We give an explicit example in 6.4.

#### 4. VARIOUS COMBINATORIAL PROPERTIES OF $\sigma_{R,L}$ .

We gather here various properties of  $\sigma_{R,L}$  which are useful for the main result of this paper. Now we always consider  $L \subset I$  such the hypothesis of the proposition 3.4 is verified.

First we make a link between  $\Sigma_{R,L}$  and the Weyl Polytope associated to a dominant weight.

**Definition 4.1.** Let  $R$  a root system, and  $\lambda \in (\Lambda_\alpha)_\mathbb{Q}$ . We define the Weyl polytope:  $\mathcal{WP}(\lambda) = \text{Conv}(W\lambda) \subset (\Lambda_\omega)_\mathbb{Q}$ .

**Remark 4.2.** Recall that if  $\lambda$  is a dominant weight then a classical result of representation theory make a link between  $\mathcal{WP}_\lambda$  and  $S^L$ :

$$\Lambda_\alpha \cap (\lambda - \mathcal{WP}(\lambda)) = S^L \cap (\lambda - \mathcal{WP}(\lambda)).$$

We deduce of this remark and of the proposition 3.3 the following proposition:

**Proposition 4.3.** Let be  $R$  a root system,  $L$  be a subset of the set of simple root which verify the hypothesis of the proposition 3.4; let  $\lambda$  be a dominant weight such that  $I_\lambda = \overline{L}$ , then the fan dual to the polytope  $\mathcal{P}_\lambda$  is equal to  $\Sigma_{R,L}$ .

Now we study the cone  $\sigma_{R,L}$ .

**Proposition 4.4.** Let's  $\sigma_{R,L}(r)$  the set of faces of  $\sigma_{R,L}$  of dimension  $r$ , we have the following equality:

$$W_L(\sigma_{R,L}(r) \cap \mathcal{D}^\vee) = \sigma_{R,L}(r).$$

*Proof.* By definition, the cone  $\sigma_{R,L}$  is stable by  $W_L$ , so if  $\mathcal{F} \in \sigma_{R,L}(r)$  and  $w \in W_L$ , then  $w\mathcal{F} \in \sigma_{R,L}(r)$ . This remark shows the inclusion  $\subset$ .

Reciprocally, let's  $\mathcal{F} \in \sigma_{R,L}(r)$ , then by definition of  $\sigma_{R,L}$ , there exists  $w \in W_L$  such that  $\mathcal{F}$  is a face of  $w\mathcal{D}^\vee$ . This remark prove the inclusion  $\supset$ . On the other hand,  $\mathcal{F}$  is a union of face  $(\mathcal{F}_w)_{w \in W_L}$  with  $\mathcal{F}_w$  is a face of the cone  $w\mathcal{D}^\vee$ . As these faces generate the same vector space, and the cone  $\sigma_{R,L}$  is strictly convex so all faces  $\mathcal{F}_w$  are equal which conclude the proof.  $\square$

**Definition 4.5.** We define the core of  $\sigma_{R,L}$ , denoted by  $\mathcal{C}(\sigma_{R,L})$ , as the face of  $D^\vee$  generating by the set  $\{\omega_i^\vee : i \in \bar{L}\}$ .

There is various way to define the core of  $\sigma_{R,L}$ .

**Proposition 4.6.** *We have following equalities:*

$$\mathcal{C}(\sigma_{R,L}) = (D^\vee)^{W_L} = \bigcap_{w \in W_L} wD^\vee = (\sigma_{R,L})^{W_L}.$$

*Proof.* This proof are left to the reader.  $\square$

For a polyhedral convex cone  $C$  in a  $\mathbb{Q}$ -vector space, we denote by  $\overset{\circ}{C}$  the relative interior of  $C$ , that is the set of positive linear combination of elements in arrays of  $C$ .

We state now elementary properties of the core but essential for the final Gorenstein Fano criteria.

**Proposition 4.7.** *We have the inclusion:*

$$\mathcal{C}(\sigma_{R,L}) \subset \overset{\circ}{\sigma}_{R,L}.$$

and the equality:

$$\overset{\circ}{\mathcal{C}}(\sigma_{R,L}) = (\overset{\circ}{\sigma}_{R,L})^{W_L}.$$

*Proof.* By a classic result on the convex polyhedral cone and by using the proposition 3.3, an element  $u$  belongs to the relative interior of  $\sigma_{R,L}$  if  $\langle \beta, u \rangle > 0$  for all  $\beta \in (R^L)^+$ .

Let  $v$  be an element of the relative interior of the core, then by definition:

$$v = \sum_{i \in \bar{I}} a_i \omega_i^\vee$$

with  $a_i > 0$  for all  $i \in I_\lambda$ . And by definition of  $(R^L)^+$ , we have  $\langle v, \beta \rangle > 0$  for all  $\beta \in (R^L)^+$ , the inclusion is proven.

We deduce that  $\overset{\circ}{\mathcal{C}}(\sigma_{R,L}) \subset (\overset{\circ}{\sigma}_{R,L})^{W_L}$ . For the reverse inclusion, suppose that  $v \in (\overset{\circ}{\sigma}_{R,L})^{W_L}$ , then  $v$  belongs to  $(D^\vee)^{W_L} \cap \overset{\circ}{\sigma}_{R,L}$  by proposition 4.6. If  $v$  belongs to a proper face of  $(D^\vee)^{W_L}$ , then by proposition 4.4,  $v$  belongs to a face of  $\sigma_{R,L}$  which is a contradiction. So  $v$  belongs to the relative interior of  $(D^\vee)^{W_L}$  which is equal to  $\overset{\circ}{\mathcal{C}}(\sigma_{R,L})$  by proposition 4.6.  $\square$

To describe  $\text{Prim}(\sigma_{R,L})$  and the affine space generated by it, we need the following definition.

**Definition 4.8.** We define  $J_L$  as the set of  $j \in \{1, 2, \dots, n\}$  such that  $\omega_j^\vee$  belongs to  $\text{Prim}(\sigma_{R,L})$ .

**Proposition 4.9.** *Let's  $L \subset I$ , let's choose  $\omega_k^\vee \in J_L$ , then we have*

(i)

$$\text{Prim}(\sigma_{R,L}) = W_L \{\omega_j^\vee \mid j \in J_L\}$$



(ii)

$$\begin{aligned} \langle \text{Prim}(\sigma_{R,L}) \rangle_{\text{aff}} &= \omega_k^\vee + \left\langle \left( \bigcup_{j \in J_L} W_L \cdot (\omega_j^\vee) - \omega_j^\vee \right) \cup \{ \omega_i^\vee - \omega_j^\vee : i, j \in J_L \} \right\rangle \\ &= \omega_k^\vee + \left\langle \{ \alpha_i^\vee : i \in L \} \cup \{ \omega_i^\vee - \omega_k^\vee : i \in J_L \} \right\rangle \end{aligned}$$

*Proof.* The point (i) is a direct consequence of the proposition 4.4.

For point (ii) first note that if  $i, j \in J_L$  and  $f, g \in W_L$ , then

$$f \cdot (-\omega_i^\vee) - g \cdot (-\omega_j^\vee) = f \cdot (-\omega_i^\vee) - \omega_i + \omega_i^\vee - \omega_j^\vee + \omega_j^\vee - g \cdot (-\omega_j^\vee),$$

and the first equality follows.

For the second equality, let  $f = s_\ell \cdots s_1 \in W_L$ , with  $s_i \in \{s_{\alpha_i^\vee} : i \in L\}$ . Then  $f \cdot (-\omega_i^\vee) - \omega_i^\vee \in \langle \alpha_i \rangle_{\mathbb{Q}}$ , and the inclusion  $\subset$  follows.

Let  $i \in L$ ; if  $s_{\alpha_i}(\nu) = \nu$  for all  $\nu \in \text{Prim}(\sigma_{R,L})$ , then  $s_{\alpha_i} = \text{Id}$ ; since  $\sigma_{R,L}$  is of maximal dimension, this is a contradiction. It follows that there exists  $\nu \in \text{Prim}(\sigma_{R,L})$  such that  $s_{\alpha_i}(\nu) \neq \nu$ , and therefore  $\alpha_i^\vee \in \langle \text{Prim}(\sigma_{R,L}) \rangle_{\text{aff}} - \omega_k$ .  $\square$

The set  $J_L$  is fundamental for describe the cone  $\sigma_{R,L}$ . By using the duality between the cone  $\sigma_{R,L}$  and the cone  $\mathbb{Q}^+ \cdot S^P$  and the work of Khare [Kha17], we can decide when a fundamental co-weight belongs to  $J_L$ . For this, we define the notion of essential fundamental co-weight relatively to  $\lambda$ .

**Definition 4.10.** Let  $\lambda$  a dominant weight and  $\mathcal{D}_\lambda$  the Dynkin diagram of  $G$ , with vertices belong to  $I_\lambda$  marked. The fundamental dominant co-weight  $\omega_i^\vee$  is essential relatively to  $\lambda$  if each irreducible components of the graph  $\mathcal{D}_\lambda \setminus \{\omega_i^\vee\}$  contains a marked vertex.

**Example 4.11.** Consider the following Dynkin diagram:

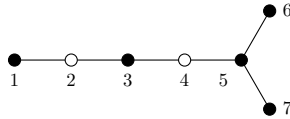

where marked points correspond to points  $\circ$ . Then the essential fundamental co-weights are:  $\{\omega_1^\vee, \omega_3^\vee, \omega_6^\vee, \omega_7^\vee\}$ .

Now we can describe the set  $J_L$ .

**Theorem 4.12.** Let  $L$  be a subset of  $I$  and  $\lambda$  a dominant weight such that  $I_\lambda = \bar{L}$ , then the fundamental co-weight  $\omega_j^\vee$  belongs to  $J_L$  if and only if  $\omega_j^\vee$  is essential relatively to  $\lambda$ .

*Proof.* The duality between  $\sigma_{R,L}$  and  $S^P$ , induces a bijection between the set  $\text{Prim}(\sigma_{R,L})$  and the set of facets of  $S^P$ . But these facets are precisely the facets of the Weyl polytope  $\mathcal{WP}(\lambda)$  containing  $\lambda$ , see remark 4.2. Facets of this Weyl polytope are described in the work of Khare [Kha17] (theorem C) in a more general setting. Traducing the condition of this theorem in our particular case implies the description of  $J_L$ .  $\square$

#### 4.1. A criteria for $\Sigma_{R,L}$ to be Gorenstein Fano.

**Definition 4.13.** Let  $G$  be a semi-simple group and  $L \subset I$ . Let's define  $\mathcal{F}_L$  as the convex hull of the set  $\text{Prim}(\sigma_{R,L})$  and  $\mathcal{P}_{R,L}$  the convex hull of  $\text{Prim}(\Sigma_{R,L})$ . Then  $\mathcal{F}_L$  is either a facet of  $-\mathcal{P}_{R,L}$  or  $n$ -dimensional. If  $\mathcal{F}_L$  is a facet, we denote by  $n_L$  the *exterior normal to the face  $\mathcal{F}_L$*  relatively to the scalar product; that is,  $n_L$  is the unique element of  $(\Lambda_\alpha^\vee)_\mathbb{Q}$  such that  $(n_L, \nu) = 1$  for all  $\nu \in \text{Prim}(\sigma_{R,L})$ . If  $\mathcal{F}_L$  is  $n$ -dimensional, we define  $n_L = 0$ .

Now we can state an useful criteria to decide which variety  $X_{R,L}$  will be Gorenstein Fano.

**Theorem 4.14.** *Let  $R$  be a root system and  $L$  be a subset of  $I$ , let's  $n_L \in (\Lambda_\alpha^\vee)_\mathbb{Q}$  defined as above, then  $X_{R,L}$  is  $\mathbb{Q}$ -Gorenstein-Fano if and only if  $n_L \in \mathring{\mathcal{C}}(\sigma_{R,L})$ . Moreover,  $X_{R,L}$  is Gorenstein Fano if  $(n_L, v) \in \mathbb{Z}$  for all  $v \in \Lambda_\alpha^\vee$ .*

*Proof.* First suppose that  $n_L \in \mathring{\mathcal{C}}(\sigma_{R,L})$ ; by the proposition 4.7, we have  $n_L \in \mathring{\sigma}_{R,L}$ . As  $\sigma_{R,L}$  is stable by  $W_L$  the vector  $n_L$  is  $W_L$  invariant. By using the action of  $W$ , for all  $w \in W$  the vector  $-wn_L$  is a normal vector to the affine space generated by  $\text{Prim}(-w\sigma_{R,L})$ . So for all  $\sigma \in \Sigma_{R,L}(n)$  the convex hull  $F_L^\sigma$  of  $\text{Prim}(\sigma)$  is of codimension 1. Moreover suppose that there exists  $w \in W$  such that  $-w.\sigma_{R,L}$  is distinct from  $-\sigma_{R,L}$  but with  $wn_L = n_L$ , then we can suppose that  $w = s_{\alpha_i}$  for  $i \in I$ , but this implies  $n_L \in (\alpha_i^\vee)^\perp$ , so  $n_L \notin (\mathring{\sigma}_{R,L})^{W_L}$  which is a contradiction.

If  $n_L \notin \mathring{\mathcal{C}}(\sigma_{R,L})$ , then by the proposition 4.6,  $n_L \in (\alpha_i)^\perp$ , with  $i \notin L$ , so the cone  $\sigma_{R,L}$  and  $s_{\alpha_i}\sigma_{R,L}$  are distincts but defined the same face of  $\text{Conv } \Sigma_{R,L}$ ; we conclude by the lemma 2.5.

The last assertion is a simple translation of the final assertion of the lemma 2.5.  $\square$

The following lemma is useful to verify the existence of the normal  $n_L$  and to compute it.

**Lemma 4.15.** *Let  $v = \sum_{i \in I} a_i \omega_i^\vee$  be a vector in  $(\Lambda_\alpha^\vee)_\mathbb{Q}$ ; we have equivalence:*

- (i) *the vector  $v$  is a non zero multiple of the normal  $n_L$  and  $v \in \mathring{\mathcal{C}}(\sigma_{R,L})$ ;*
- (ii) *The two conditions are verified:*
  - (a)  *$a_i > 0$  for all  $i \in \bar{L}$  and  $a_i = 0$  for  $i \in L$ ;*
  - (b) *the scalar product  $(v, \omega_j^\vee)$  is independent of  $j$  for all  $j \in J_L$ .*

*Proof.* Recall that a normal vector  $v$  to the affine space generated by  $\text{Prim}(\sigma_{R,L})$  is  $W_L$  invariant, so it is sum of the vector  $\omega_i^\vee$  for  $i \in L$  and also a sum of the root  $\alpha_i^\vee$  with  $i \in L$ .

By proposition 4.9 the direction to the affine space generated by  $\text{Prim}(\sigma_{R,L})$  is equal to:

$$\left\langle \{\alpha_i : i \in L\} \cup \{\omega_i^\vee - \omega_k^\vee : i \in J_L\} \right\rangle.$$

So a vector  $v$  which is a sum of  $\omega_i^\vee$  for  $i \in \bar{L}$  is a normal vector to this affine space if and only if the condition (b) is verified. The positivity of the coefficient  $a_i$  for  $i \in \bar{L}$  is equivalent to  $v \in \mathring{\mathcal{C}}$ .  $\square$

The following lemma permits to show that numerous variety  $\Sigma_{R,L}$  are not Gorenstein Fano. So its statement avoids repeating the same argument several times.

**Lemma 4.16.** *Let  $j, j'$  be two distinct elements  $j, j'$  in  $J_L$ ; let's define:*

$$b_i = (\omega_i^\vee, \omega_{j'}^\vee - \omega_j^\vee)$$

for  $i \in \bar{L}$ ; suppose that  $(b_i)_{i \in \bar{L}}$  are non negative but not all zero. Then there is no vector  $n$  proportional to  $n_L$  and such that:

$$n = \sum_{i \in \bar{L}} a_i \omega_i^\vee$$

with  $a_i$  positive for all  $i \in \bar{L}$ .

*Proof.* By absurd, suppose there exists a vector  $n$  proportional to  $n_L$  such that  $n = \sum_{i \in \bar{L}} a_i \omega_i^\vee$  with  $a_i$  positive for all  $i \in \bar{L}$ ; then by the lemma 4.15, we have  $(n, \omega_{j'}^\vee) = (n, \omega_j^\vee)$  for all  $(j, j') \in J_L^2$ . But this implies:

$$0 = (n, \omega_{j'}^\vee - \omega_j^\vee) = \sum_{i \in \bar{L}} a_i b_i$$

but by the hypothesis the last sum is positive and cannot be equal to zero.  $\square$

## 5. FANO GENERIC CLOSURES

**Theorem 5.1.** *The table next page gives a complete list of all  $\mathbb{Q}$ -Gorenstein-Fano, Gorenstein-Fano and Fano among varieties obtained by closures of generic orbits of  $T$  in  $G/P$ , where  $G$  is a simple algebraic group and  $P$  a class of conjugation of parabolic groups of  $G$ . The first column give the irreducible root system  $R$  of  $G$ . In the second column, there is the Dynkin diagram of  $R^\vee$  where the vertices belong to the set  $L$  are in black. In the third column, we give some information about the geometry of the variety.*

type( $G$ )	rank	Dynkin( $R^\vee$ ) and $L$	Geometry
$A_n$	$n \geq 1$		Smooth, Fano
	$n \geq 2$		Gorenstein Fano
	$n$ odd, $n \geq 3$		Gorenstein Fano
	$n$ even, $n \geq 4$		Smooth, Fano
$B_n$	$n \geq 2$		Gorenstein Fano
			Smooth, Fano
$C_n$	$n \geq 3$		Gorenstein Fano
			Gorenstein Fano
			Gorenstein Fano, if $n$ even $\mathbb{Q}$ -Gorenstein Fano, if $n$ odd
$D_n$	$n \geq 4$		Gorenstein Fano
			Gorenstein Fano
$E_6$	6		Gorenstein Fano
$F_4$	4		$\mathbb{Q}$ -Gorenstein Fano
			Gorenstein Fano
$G_2$	2		$\mathbb{Q}$ -Gorenstein Fano
			Smooth, Fano

**Remark 5.2.** (i) The list is modulo automorphisms of the root system; for example, varieties  $X_{(A_n, L \setminus \{1\})}$  and  $X_{(A_n, L \setminus \{n\})}$  are isomorphic (and both Fano). In the same spirit, conditions given on the rank permit to avoid repetition.  
 (ii) In cases of strict  $\mathbb{Q}$ -Gorenstein Fano, the index is two for  $B_n$  and  $F_4$  cases and three for the  $G_2$  case.

6. PROOF OF THEOREM 5.1 IN RANK 1 AND 2

These cases are straight forward, and the classification can be done just by examination of the figures of root systems. In figures 1–8, for each couple  $(R, L)$ , we draw the cone  $\sigma_{R,L}$  in gray.

6.1. **The case  $n = 1$ .** In this case, there is just one couple possible  $A_1, \{1\}$ ; the associated variety is  $\mathbb{P}^1$  which is Fano.

6.2. **Explicit calculations for  $G$  of type  $A_1 \times A_1$ .** In this case the Dynkin diagram is:



To have the hypothesis of the proposition 3.4 verified, we have to choose  $L = I = \{1, 2\}$ ; then  $X_{R,L}$  is isomorphic to  $\mathbb{P}^1 \times \mathbb{P}^1$  and is a Fano variety.

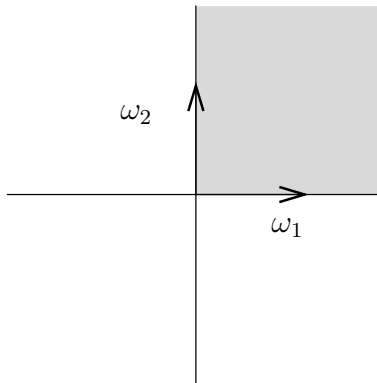

FIG. 1.

6.3. **Explicit calculations for  $G$  of type  $R = A_2$ .** The Dynkin diagram of  $R$  and  $R^\vee$  are the same:



As follows from figures 2 and 3,  $\Sigma_{A_2, L}$  is a smooth Fano complete fan for all  $L$  strict subset of  $I = \{1, 2\}$ . The variety  $X_{A_2, \{1\}}$  and  $X_{A_2, \{2\}}$  are isomorphic to  $\mathbb{P}^2$  and  $X(A_2, \emptyset)$  is isomorphic to the blowing of  $\mathbb{P}^2$  in three generic points.

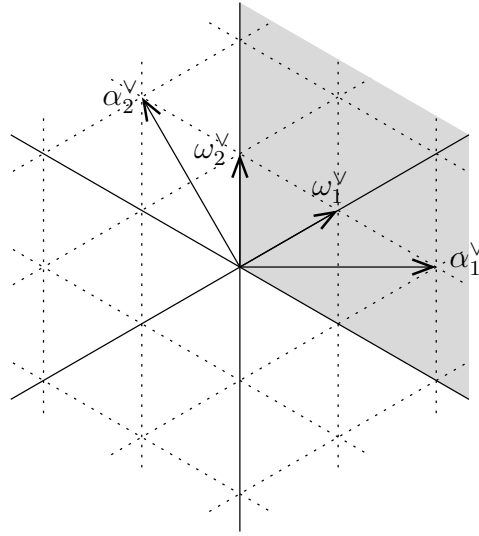

FIG. 2.

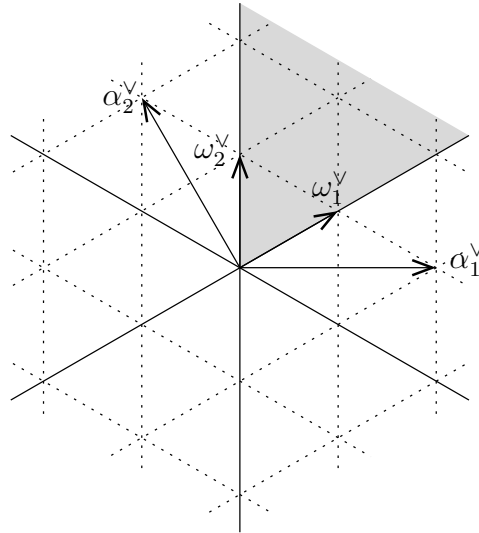

FIG. 3.

6.4. **Explicit calculations for  $G$  of type  $R = B_2$ .** The Dynkin diagram of  $R = B_2$  is:



and the dynkin diagrams of  $R^\vee = C_2$  is:



Then we have two possibilities for  $L$  such that  $X(B_2, L)$  is Gorenstein Fano. First if  $L = \{1\}$  which corresponds to the figure 4, the variety  $X(B_2, \{1\})$  is a smooth Fano variety isomorphic to  $\mathbb{P}^1 \times \mathbb{P}^1$ .

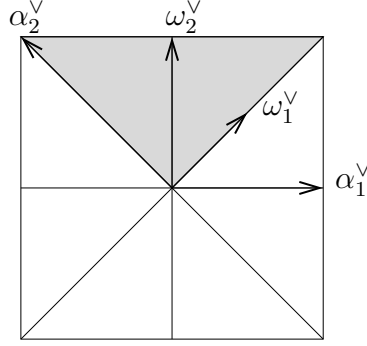

FIG. 4.

The second possibility is  $L = \{2\}$  which corresponds to the figure 5. The associated variety is not smooth. Following Dabrowski [Dab96], we give an explicit description of this variety: on  $V = \mathbb{k}^5$  and in the canonical basis  $(e_1, \dots, e_5)$ , let  $q$  be the non-degenerate quadratic form  $q(x) = x_1x_3 + x_2x_4 - 2x_5$ . Let  $G = SO(q)$  be the subgroup of determinant one linear transformations of  $V$ , preserving  $q$ . Then  $G$  is a connected, rank 2, simple algebraic group over  $\mathbb{k}$  of root system  $B_2$ . Let  $l$  be the line generated by  $e_1$ , and let  $P \subset G$  be the stabilizer of  $l$ . Then  $P$  is the parabolic subgroup of  $G$  such that  $W_P = W_L$  with  $L = \{2\}$ . Moreover  $G/P$  is naturally isomorphic to the smooth quadric hypersurface  $Q$  in the complex projective space  $\mathbb{P}(V)$  given by the homogeneous equation  $q(x) = 0$ . The torus  $T$  is equal to  $\{\text{diag}(t_1, t_2, l/t_1, 1/t_2, 1) : t_i \in \mathbb{k}^*, i = 1, 2\}$ . The orbit of the line generating by the vector  $v = (1, 1, 1, 1, 1)$  is generic and its closure  $X = \overline{T \cdot (\mathbb{k}v)}$  is the singular closed subvariety of  $\mathbb{P}(V)$  given by homogeneous equations  $x_1x_3 = x_5^2, x_2x_4 = x_5^2$  (the singular points of  $X$  are  $[1 : 1 : 0 : 0 : 0]$ ,  $[1 : 0 : 0 : 1 : 0]$ ,  $[0 : 1 : 1 : 0 : 0]$ , and  $[0 : 0 : 1 : 1 : 0]$ ). Therefore the fact that the fan of the generic orbits belongs to the space generated by coroots is essential in the non simply laced case.

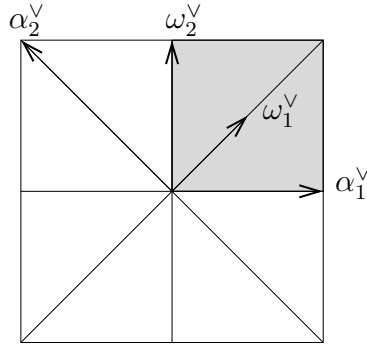

FIG. 5.

6.5. **Explicit calculations for  $G$  of type  $R = G_2$ .** The Dynkin diagram are the following:

$$R : \begin{array}{c} \bullet \rightleftarrows \bullet \\ 1 \quad 2 \end{array} \quad R^\vee : \begin{array}{c} \bullet \rightleftarrows \bullet \\ 1 \quad 2 \end{array}$$

For completeness, we give the matrix of a scalar product on  $(\Lambda_\alpha^\vee)_\mathbb{Q}$   $W$ -invariant:

$$\begin{pmatrix} 2 & 3 \\ 3 & 6 \end{pmatrix}$$

Then there is only two possibilities for  $L$  such that  $X(G_2, L)$  is Gorenstein Fano. First the case  $L = \{1\}$  which correspond to the figure 6. The associated variety

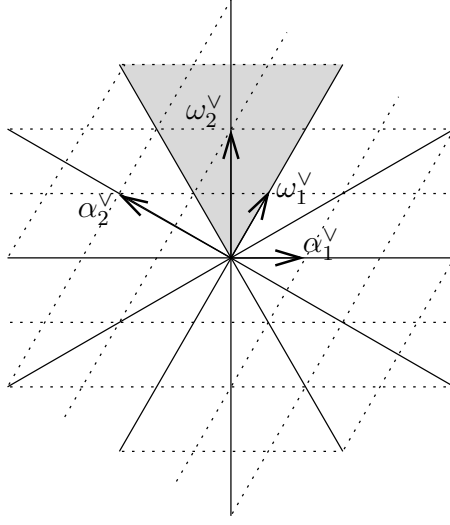

FIG. 6.

is Fano and isomorphic as  $\mathbb{P}^2$  blowing up in three generic points (as in the case associated to  $(R, L) = (A_2, \emptyset)$ ).

The second possibility is the case  $L = \{2\}$  which corresponds to the figure 7. The variety is  $\mathbb{Q}$ -Gorenstein Fano of Gorenstein index 3.

**Example 6.1.** Let  $G$  be of type  $G_2$ , and consider  $\Sigma$  as in the picture 8; clearly,  $\Sigma$  is a smooth complete fan. However,  $\Sigma$  does not correspond to a generic  $T$ -orbit of an homogeneous space  $G/P$ . Thus, there exists Fano toric varieties whose maximal cones are union of Weyl chambers, but are not of the form  $\Sigma_{R,L}$  for some subset  $L$ .

## 7. PROOF OF THEOREM 5.1 FOR RANK $n \geq 3$

Here we give the calculation for all type for rank  $n \geq 3$ . The strategy is similar for all cases. For each root system  $R$ , we describe for the dual root system  $R^\vee$  a matrix of a scalar product  $W$ -invariant in the basis of the fundamental co-weight. Note that this matrix is a multiple of the symmetrized of the inverse of the Cartan Matrix associated to  $R^\vee$ . This inverse is given for example in the book of Onischik and Vinberg [OV90] (p295) or in a article of Wei and Zou [WZ17]. Then for each



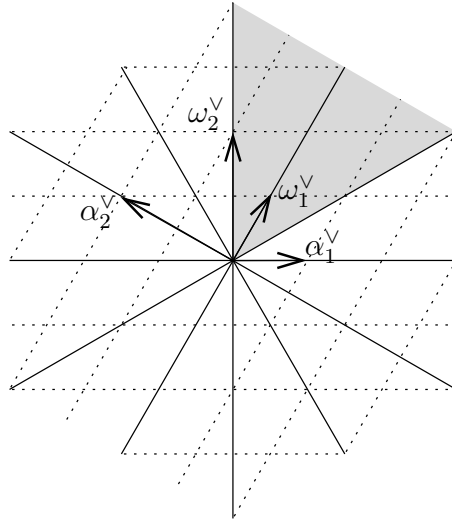

FIG. 7.

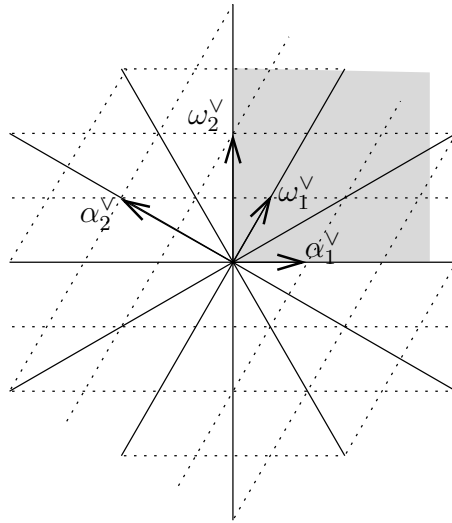
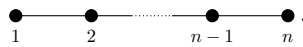

FIG. 8.

$L$ , we compute the rays of  $\sigma_{R,L}$  which belongs to  $D^\vee$  with the proposition 4.4 and then we deduce the normal to the face  $\mathcal{F}_L$ . Note that for simplicity of computing, we reason on  $\bar{L}$  rather than  $L$ .

**7.1. Explicit calculations for  $G$  of type  $A_n$ ,  $n \geq 3$ .** Here  $R$  and  $R^\vee$  are isomorphic, with following Dynkin diagram:



The matrix in the basis of fundamental (co)-weight of a  $W$ -invariant scalar product is:

$$\begin{pmatrix} n & n-1 & n-2 & \dots & \dots & \dots & 2 & 1 \\ n-1 & 2(n-1) & 2(n-2) & \dots & \dots & \dots & 2.2 & 2 \\ \vdots & \vdots & \vdots & \dots & \dots & \dots & \vdots & \vdots \\ n-i+1 & 2(n-i+1) & \dots & i(n-i+1) & i(n-i) & \dots & i.2 & i \\ \vdots & \vdots & \vdots & \dots & \dots & \dots & \vdots & \vdots \\ 1 & 2 & 3 & \dots & \dots & \dots & n-1 & n \end{pmatrix}$$

Let  $L$  be a subset of  $I = \{1, 2, \dots, n\}$ ; we denote by  $m$  (resp.  $M$ ) the minimum (resp. the maximum) of the set  $\bar{L}$ .

7.1.1. *Case  $\bar{L} = \{1\}$ .* In this case  $J_L$  contains a single element:  $\omega_n^\vee$ . Then by the corollary 4.9, any vector proportional to  $\omega_1^\vee$  has a scalar product constant with all elements in  $\text{Prim}(\sigma_{R,L})$ , and  $\mathcal{F}_L$  is of dimension  $n-1$ . The vector  $n_L$  defined in definition 4.13 is so equal to  $\omega_1^\vee$ . The variety  $\Sigma_{R,L}$  is Fano: indeed in this case, the set  $\text{Prim}(\sigma_{R,L})$  can be computing (see remark (4) in [VoK185]):

$$\text{Prim}(\sigma_{R,L}) = W_L \cdot (\omega_n^\vee) = \{\omega_n^\vee, \omega_{n-1}^\vee - \omega_n^\vee, \omega_{n-2}^\vee - \omega_{n-1}^\vee, \dots, \omega_1^\vee - \omega_2^\vee\}.$$

So, rays of the cone  $\sigma_{R,L}$  is a basis of the weight lattice and the variety  $X_{R,L}$  is Fano.

Note that the case  $\bar{L} = \{n\}$  is similar by using the symmetry of the Dynkin diagram.

7.1.2. *Case  $\bar{L} = \{i\}$   $i \neq 1, n$ .* In this case  $J_L$  contains  $\omega_1^\vee$  and  $\omega_n^\vee$ . We verify that  $(\omega_1^\vee, \omega_i^\vee) \neq (\omega_n^\vee, \omega_i^\vee)$ , except if  $n = 2i - 1$ . So if  $n \neq 2i - 1$ , the variety  $\Sigma_{R,L}$  is not Fano. If  $n = 2i - 1$ , then  $\mathcal{F}_L$  is of dimension  $n-1$ . The scalar product  $(\omega_i^\vee, \omega_n^\vee)$  is equal to  $i$ , so

$$n_L = \frac{\omega_i^\vee}{i}.$$

Then, we verify that  $(n_L, \omega_j^\vee)$  is an integer for all  $j \in \{1, 2, \dots, n\}$  and so  $\Sigma_{R,L}$  is Gorenstein Fano. Note that  $\text{Prim}(\sigma_{R,L})$  is the union of the two orbits:

$$W_L \cdot (\omega_1^\vee) = \{\omega_1^\vee, \omega_2^\vee - \omega_1^\vee, \dots, \omega_i^\vee - \omega_{i-1}^\vee\}$$

and

$$W_L \cdot (\omega_n^\vee) = \{\omega_n^\vee, \omega_{n-1}^\vee - \omega_n^\vee, \dots, \omega_i^\vee - \omega_{i+1}^\vee\}.$$

So  $\text{Prim}(\sigma_{R,L})$  is not simplicial and  $\Sigma_\lambda$  is not smooth.

7.1.3. *Case  $M = m + 1$ .* In this case the set  $J_L$  contains two elements: 1 and  $n$ . Let  $n_L$  be the vector as in the definition 4.13, suppose that  $n_L = a\omega_m^\vee + b\omega_{m+1}^\vee$ , with  $a, b$  two positive rational numbers such that  $(n_L, \omega_1^\vee - \omega_n^\vee) = 0$ . But, as

$$(\omega_i^\vee, \omega_1^\vee - \omega_n^\vee) = n - 2i + 1$$

we must have:

$$(a+b)(n-2m) + (a-b) = 0.$$

If  $n \neq 2m$ , this equation has no solution and  $\Sigma_{R,L}$  is not Fano. If  $n = 2m$ , then the face  $\mathcal{F}_L$  is of dimension  $n-1$  and is orthogonal to  $\omega_m^\vee + \omega_{m+1}^\vee$ . We have

$n_L = (\omega_m^\vee + \omega_{m+1}^\vee)$ . In this case, the variety  $\Sigma_{R,L}$  is Fano. Indeed,  $\text{Prim}(\sigma_{R,L})$  is equal to the union of the two orbits:  $W_L(\omega_1^\vee) \cup W_L(\omega_n^\vee)$ . But this two orbits are:

$$W_L(\omega_1^\vee) = \{\omega_1^\vee, \omega_2^\vee - \omega_1^\vee, \dots, \omega_m^\vee - \omega_{m-1}^\vee\}$$

and

$$W_L(\omega_n^\vee) = \{\omega_n^\vee, \omega_{n-1}^\vee - \omega_n^\vee, \dots, \omega_{m+1}^\vee - \omega_{m+2}^\vee\}.$$

And this union is a basis of the weight lattice.

7.1.4. *Case  $\#\bar{L} \geq 2$ ,  $M < n$  and  $m \neq M - 1$ .* In this case, the set  $J_L$  is given by:

$$\{1\} \cup \{m+1, \dots, M-1\} \cup \{n\}.$$

Let  $n_L$  be the vector normal to  $\mathcal{F}_L$  such that :

$$n_L = \sum_{i \in \bar{L}} a_i \omega_i^\vee$$

with  $a_i > 0$ . Then as  $n$  and  $M - 1$  belong to  $J_L$  we have:

$$(1) \quad \sum_{i \in \bar{L}} a_i (\omega_i^\vee, \omega_{M-1}^\vee - \omega_n^\vee) = 0.$$

The coefficient of the  $i$ -th row of the matrix of the scalar product is a strict unimodal sequence with peak at the  $i$ -place, so:  $(\omega_i^\vee, \omega_{M-1}^\vee - \omega_n^\vee) > 0$  for all  $i$  such that  $i \leq M - 1$ . And as  $M < n$ , we also have:  $(\omega_M^\vee, \omega_{M-1}^\vee - \omega_n^\vee) > 0$ . Since  $L \subset \{m, m+1, \dots, M\}$ , we can using the proposition 4.16 and  $\Sigma_{R,L}$  is not Gorenstein Fano.

The case  $\#I_\lambda \geq 2$ ,  $1 < m$  and  $m \neq M - 1$  is obtained from the preceding one by using the automorphism of the Dynkin diagram. So the following is the last case.

7.1.5. *Case  $m = 1$  and  $M = n$ .* Here we have  $J_L = \{1, \dots, n\}$ . Let  $n_L$  be the vector normal to the face  $\mathcal{F}_L$ , then as

$$(\omega_1^\vee + \omega_n^\vee, \omega_j^\vee - \omega_{j'}^\vee) = 0$$

$n_L$  is proportional to  $\omega_1^\vee + \omega_n^\vee$ . So if  $\bar{L} \neq \{1, n\}$ ,  $\Sigma_{R,L}$  is not Gorenstein-Fano.

If  $\bar{L} = \{1, n\}$ , then it is easy to verify that:

$$n_L = \frac{\omega_1^\vee + \omega_n^\vee}{n+1},$$

and that  $\Sigma_{R,L}$  is Gorenstein-Fano, but not Fano because the cone  $\text{Prim}(\sigma_{R,L})$ , which is convex hull of

$$W_L.\{\omega_j^\vee \mid j \in J_L\}$$

is clearly not simplicial.

### 7.2. Explicit calculations for $G$ of type $B_n$ .

The Dynkin diagram of the root system  $B_n$  is:



and  $R^\vee$  is the root system  $C_n$  with Dynkin diagram:

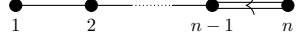

A  $W$ -scalar product matrix in the basis of the fundamental co-weight (relatively to  $R^\vee$ ) is given by:

$$\begin{pmatrix} 1 & 1 & 1 & \dots & \dots & \dots & 1 & 1 \\ 1 & 2 & 2 & \dots & \dots & \dots & 2 & 2 \\ \vdots & \vdots & & \dots & \dots & \dots & \vdots & \vdots \\ 1 & 2 & 3 & \dots & i & \dots & i & i \\ \vdots & \vdots & & \dots & \dots & \dots & \vdots & \vdots \\ 1 & 2 & 3 & \dots & \dots & \dots & n-1 & n \end{pmatrix}$$

7.2.1. *Case  $\#\bar{L} = 1$ .* Suppose that  $\bar{L} = \{i\}$  with  $i \neq 1, n$ . Then  $J_L = \{1, n\}$ , and  $n_L$  is proportional to  $\omega_i^\vee$ . Then by considering the matrix of the scalar product, we have  $(\omega_1^\vee, \omega_i^\vee) = 1$  and  $(\omega_n^\vee, \omega_i^\vee) = i$ , so  $n_L = 0$  and  $\Sigma_{R,L}$  is not Gorenstein Fano.

Suppose now that  $\bar{L} = \{1\}$ , then  $J_L = \{n\}$ . As  $(\omega_1^\vee, \omega_n^\vee) = 1$ , we have  $n_L = \omega_1^\vee$  and the variety is Gorenstein-Fano. By considering the cardinality of the  $W_L$  orbits of  $\omega_n^\vee$ , we see that the cone  $\sigma_L$  is not simplicial and the  $X_{R,L}$  cannot be smooth.

Finally, suppose that  $\bar{L} = \{n\}$ , then  $J_L = \{1\}$  and we have  $n_L = \omega_n^\vee$  and the variety is Gorenstein Fano. Moreover, we have  $W_L \cdot \omega_1^\vee = \{\omega_1, \omega_2 - \omega_1, \dots, \omega_n - \omega_{n-1}\}$  (see remark (4) in [VoKl85]) and so the  $X_{R,L}$  is smooth.

7.2.2. *Case  $\#\bar{L} > 1$ .* In this case, because  $n \geq 3$ , the set  $J_L$  contains at least two elements, let's denote it by  $j' > j$ . By considering the scalar product matrix, we have the following inequalities:

$$(2) \quad (\omega_{j'}^\vee, \omega_i^\vee) \geq (\omega_j^\vee, \omega_i^\vee)$$

for all  $i \in I$ . So we can apply the lemma 4.16 and the variety  $X_{R,L}$  is not Gorenstein Fano.

### 7.3. Explicit calculations for $G$ of type $C_n$ .

This case is the symmetric of the precedent. The matrix of a scalar product is equal to:

$$\begin{pmatrix} 2 & 2 & 2 & \dots & \dots & \dots & 2 & 1 \\ 2 & 4 & 4 & \dots & \dots & \dots & 4 & 2 \\ \vdots & \vdots & & \dots & \dots & \dots & \vdots & \vdots \\ 2 & 4 & 6 & \dots & 2i & \dots & 2i & i \\ \vdots & \vdots & & \dots & \dots & \dots & \vdots & \vdots \\ 1 & 2 & 3 & \dots & \dots & \dots & n-1 & n/2 \end{pmatrix}$$

7.3.1. *Case  $\#\bar{L} = 1$ .* Suppose that  $\bar{L} = \{i\}$  with  $i \neq 1, 2, n$ . Then  $J_L = \{1, n\}$ , and the vector normal to  $n_L$  is proportional to  $\omega_i^\vee$ . Then by considering the matrix of the scalar product, we have  $(\omega_1^\vee, \omega_i^\vee) = 2$  and  $(\omega_n^\vee, \omega_i^\vee) = i$ , so  $n_L = 0$  and  $\Sigma_{R,L}$  is not Gorenstein Fano.

The case  $\bar{L} = \{1\}$  is quite similar to the case  $R = B_n$  and  $\bar{L} = 1$ , we do not give the details.

Suppose that  $\bar{L} = \{n\}$ , then  $J_L = \{1\}$  and  $n_L = \omega_n^\vee$ , but as  $(\omega_n^\vee, \omega_i^\vee) = i$  if  $i \neq n$  and  $(\omega_n^\vee, \omega_n^\vee) = n/2$  the variety is Gorenstein Fano if  $n$  is even, and  $\mathbb{Q}$ -Gorenstein Fano of index 2 if  $n$  is odd. It is easy to computing the  $W_L$  orbit of  $\omega_n^\vee$ , it is equal to  $:\{\omega_1, \omega_2 - \omega_1, \dots, 2\omega_n - \omega_{n-1}\}$  (see remark (5) in [VoK185]), so the fan  $\Sigma_{R,L}$  is simplicial but not smooth.

Now suppose that  $L = \{2\}$ . We have  $J_L = \{1, n\}$  and we have following equalities:

$$(\omega_1^\vee, \omega_2^\vee) = 2 = (\omega_n^\vee, \omega_2^\vee).$$

So the vector normal  $n_L$  is equal to  $(\omega_2^\vee)/2$ . The variety is Gorenstein Fano, but not smooth because  $\sigma_L$  is not simplicial.

7.3.2. *Case  $\#\bar{L} > 1$ .* If  $\bar{L} \neq \{n-1, n\}$  then  $J_L$  contains two elements  $j' > j$  with  $j' \neq n$ , then by using the lemma 4.16, we have that the corresponding variety is not Gorenstein Fano.

If  $\bar{L} = \{n-1, n\}$ , then  $J_L = \{1, n\}$ . By a simple calculation, we verify that there is no vector  $n_L = a\omega_{n-1}^\vee + b\omega_n^\vee$  such that  $(n_L, \omega_1^\vee - \omega_n^\vee) = 0$  for positive  $a$  and  $b$ .

7.4. **Explicit calculations for  $G$  of type  $R = D_n$ .** In this case  $R$  and  $R^\vee$  are isomorphic with the same Dynkin diagram:

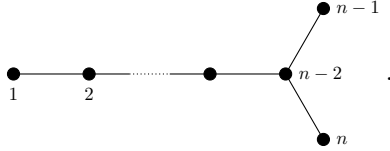

and the matrix of a scalar product is:

$$\begin{pmatrix} 4 & 4 & 4 & \dots & \dots & 4 & 2 & 2 \\ 4 & 8 & 8 & \dots & \dots & 8 & 4 & 4 \\ \vdots & \vdots & & \dots & \dots & \dots & \vdots & \vdots \\ 4 & 8 & 12 & \dots & & 4i & 2i & 2i \\ \vdots & \vdots & & \dots & \dots & \dots & \vdots & \vdots \\ 2 & 4 & 6 & \dots & \dots & 2(n-2) & n & n-2 \\ 2 & 4 & 6 & \dots & \dots & 2(n-2) & n-2 & n \end{pmatrix}$$

7.4.1. *Case  $\#\bar{L} = 1$ .* Then  $\bar{L} = \{i\}$ ; suppose first that  $i \neq 1, 2, n-1, n$  and  $n > 4$ . Then  $J_L$  is equal to  $\{1, n-1, n\}$ . We have  $(\omega_i^\vee, \omega_1^\vee) = 4$  but  $(\omega_n^\vee, \omega_1^\vee) \neq 4$  so the variety  $X_{R,L}$  is not Gorenstein Fano.

Suppose that  $\bar{L} = \{n\}$ , then  $J_L = \{1, n-1\}$  but  $(\omega_1^\vee, \omega_n^\vee) \neq (\omega_{n-1}^\vee, \omega_n^\vee)$  and the associated variety is not Gorenstein Fano. Note that by using the symmetry of the Dynkin diagram, the case  $\bar{L} = \{n-1\}$  is identical to the case  $\bar{L} = \{n\}$ .

Suppose now that  $\bar{L} = \{1\}$ , then  $J_L = \{n-1, n\}$ . Clearly  $(\omega_1^\vee, \omega_n^\vee) = (\omega_1^\vee, \omega_{n-1}^\vee)$  and  $n_L = (\omega_1^\vee)/2$  is the normal to  $\mathcal{F}_L$ . As  $(n_L, \omega_i^\vee)$  is an integer for all  $i \in I$ , the variety  $X_{R,L}$  is Gorenstein Fano. The cone  $\sigma_L$  is not simplicial, this variety is not smooth.

If  $\bar{L} = \{2\}$ , then  $J_L = \{1, n-1, n\}$ . By considering the scalar products,  $(\omega_2^\vee, \omega_1^\vee)$ ,  $(\omega_2^\vee, \omega_{n-1}^\vee)$ ,  $(\omega_2^\vee, \omega_n^\vee)$ , we see that the normal  $n_L$  is equal to  $(\omega_2^\vee)/4$  and the variety  $X_{R,L}$  is Gorenstein Fano.

Finally in the case  $n = 4$ , by using the extra symmetry of  $D_4$ , we remark that all varieties  $X_{R,L}$  with  $\#\bar{L} = 1$  are Gorenstein Fano.

7.4.2. *Case  $\#\bar{L} > 1$ .* We use again the lemma 4.16 by distinguish two cases: first  $L \neq \{n-1, n\}$  and second the case  $L = \{n-1, n\}$ .

7.5. **Explicit calculations for  $G$  of type  $R = E_6, E_7, E_8$ .** In this case  $R$  and  $R^\vee$  are isomorphic and the Dynkin diagram are:

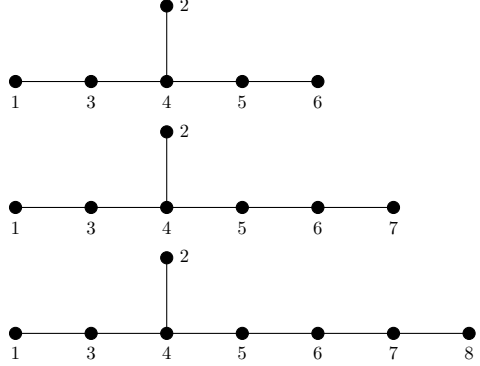

We choose the following matrix of the scalar product:

$$\begin{pmatrix} 4 & 3 & 5 & 6 & 4 & 2 \\ 3 & 6 & 6 & 9 & 6 & 3 \\ 5 & 6 & 10 & 12 & 8 & 4 \\ 6 & 9 & 12 & 18 & 12 & 6 \\ 4 & 6 & 8 & 12 & 10 & 5 \\ 2 & 3 & 4 & 6 & 5 & 4 \end{pmatrix}$$

$$\begin{pmatrix} 4 & 4 & 6 & 8 & 6 & 4 & 2 \\ 4 & 7 & 8 & 12 & 9 & 6 & 3 \\ 6 & 8 & 12 & 16 & 12 & 8 & 4 \\ 8 & 12 & 16 & 24 & 18 & 12 & 6 \\ 6 & 9 & 12 & 18 & 15 & 10 & 5 \\ 4 & 6 & 8 & 12 & 10 & 8 & 4 \\ 2 & 3 & 4 & 6 & 5 & 4 & 3 \end{pmatrix}$$

$$\begin{pmatrix} 4 & 5 & 7 & 10 & 8 & 6 & 4 & 2 \\ 5 & 8 & 10 & 15 & 12 & 9 & 6 & 3 \\ 7 & 10 & 14 & 20 & 16 & 12 & 8 & 4 \\ 10 & 15 & 20 & 30 & 24 & 18 & 12 & 6 \\ 8 & 12 & 16 & 24 & 20 & 15 & 10 & 5 \\ 6 & 9 & 12 & 18 & 15 & 12 & 8 & 4 \\ 4 & 6 & 8 & 12 & 10 & 8 & 6 & 3 \\ 2 & 3 & 4 & 6 & 5 & 4 & 3 & 2 \end{pmatrix}$$

7.5.1.  $\#\bar{L} = 1$ . Suppose that  $\bar{L}$  contains a single element  $i$  with  $1 \leq i \leq n$  (with  $n = 6, 7, 8$ ). Then by considering all possibilities of  $J_L$  and products  $((\omega_i^\vee, \omega_j^\vee)$  with  $j \in J_L$ , we can see that the only possibility for  $X_{(E_n, L \setminus \{i\})}$  to be Gorenstein Fano is  $n = 6$  and  $i = 2$ . In this case we have  $J_L = \{1, 6\}$ ,  $n_L = (\omega_2^\vee)/3$  and the variety is Gorenstein Fano and not smooth because  $\sigma_{R,L}$  is not simplicial.

7.5.2.  $\#\bar{L} > 1$ . Then the set  $J_L$  contains always 1, 2 and  $n$ ; if  $n \neq 6$  or if  $n = 6$  and  $1 \notin \bar{L}$ , suppose that

$$n_L = \sum_{i \in \bar{L}} a_i \omega_i^\vee$$

with  $a_i > 0$  for all  $i \in \bar{L}$ , then as  $(n_L, \omega_2^\vee) \geq (n_L, \omega_1^\vee)$ , the variety  $X_{R,L}$  is not Gorenstein Fano by the lemma 4.16.

If  $n = 6$  and suppose that  $1 \in \bar{L}$ , then in the two sub-cases  $6 \in \bar{L}$  and  $6 \notin \bar{L}$ , we conclude that the corresponding variety is not Gorenstein Fano by using the lemma 4.16.

**7.6. Explicit calculations for  $G$  of type  $F_4$ .** The Dynkin diagram of  $R$  is the following:

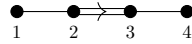

and that of  $R^\vee$  is:

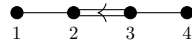

We choose the scalar product in  $(\Lambda_\alpha^\vee)_\mathbb{Q}$  given by the following matrix:

$$\begin{pmatrix} 2 & 3 & 4 & 2 \\ 3 & 6 & 8 & 4 \\ 4 & 8 & 12 & 6 \\ 2 & 4 & 6 & 4 \end{pmatrix}$$

7.6.1. *Case  $\#\bar{L} = 1$ .* Suppose that  $\bar{L} = \{i\}$ , then if  $i$  is not equal to 1 or 4, then  $J_L$  contains 1 and 4 and in the two case a non zero vector  $n_L$  orthogonal to  $\mathcal{F}_L$  does not exist.

If  $i = 1$ , then  $J_L = \{4\}$ , so  $n_L = (\omega_1^\vee)/2$ , the variety is  $\mathbb{Q}$ -Gorenstein Fano of Gorenstein index 2. If  $i = 4$ , then  $J_L = \{1\}$ , and  $n_L = (\omega_4^\vee)/2$ , the variety is Gorenstein Fano but not smooth.

7.6.2. *Case  $\#\bar{L} > 1$ .* In this case  $J_L$  contains at least 1, 4. But for all  $j \in I$ , we have  $(\omega_j^\vee, \omega_4^\vee) > (\omega_j^\vee, \omega_1^\vee)$ , and we conclude with the lemma 4.16.

## 8. SOME PAIRS OF DUAL REFLEXIVE POLYTOPES

Let's recall some definitions. If  $\mathcal{P} \subset \Lambda_{\mathbb{Q}}$  is a lattice polytope, the dual polytope  $\mathcal{P}^{\circ}$  of a polytope  $\mathcal{P}$  is defined by:

$$\mathcal{P}^{\circ} = \{u \in \Lambda_{\mathbb{Q}}^{\vee} : \langle v, u \rangle \geq -1 \forall v \in \mathcal{P}\}.$$

If  $\mathcal{P}^{\circ}$  is a lattice polytope,  $\mathcal{P}$  is called a reflexive polytope. It is well-known that a toric projective variety  $X_{\Sigma}$  is Gorenstein Fano if and only if the polytope  $\mathcal{P}_{R,L} = \text{Conv}(\text{Prim}(\Sigma))$  is reflexive (see for example theorem 8.3.4 of [CLS11]). So the classification of Gorenstein Fano varieties  $X_{R,L}$  give a list of a pair of dual lattice polytopes  $(\mathcal{P}_{R,L}, \mathcal{P}_{R,L}^{\circ})$ .

To describe this two polytopes, we recall some facts. The couple  $(L, J_L)$  determine completely the polytope  $\mathcal{P}_{R,L}$ . Note that if  $J_L$  contains a single fundamental co-weight  $\omega^{\vee}$ , then  $\mathcal{P}_{R,L}$  is simply the Weyl polytope  $\mathcal{WP}(-\omega^{\vee})$ .

On the other hand, the dual polytope  $\mathcal{P}_{R,L}^{\circ}$  can be defined as

$$\mathcal{P}_{R,L}^{\circ} = \text{Conv}\{u_F : \mathcal{F} \text{ facet of } \mathcal{P}_{R,L}\}$$

where  $u_F \in \Lambda_{\alpha}$  is the inward-pointing facet normal. If  $X_{R,L}$  is Gorenstein Fano, the outward-pointing normal (related to the scalar product) to the cone  $\sigma_{R,L}$  is the vector  $n_L \in (\Lambda_{\alpha}^{\vee})$ . So the set of the inward-pointing facet normal to  $\mathcal{P}_{R,L}$  are the  $W$ -orbit  $W \cdot \varphi_{n_L}$ , where  $\varphi_{n_L} \in \Lambda_{\alpha}$  is defined by  $\langle \varphi_{n_L}, u \rangle = (n_L, u)$  for all  $u \in \Lambda_{\alpha}^{\vee}$ . From this discussion, we deduce the following proposition:

**Proposition 8.1.** *If the variety  $X_{R,L}$  is Gorenstein Fano the weight lattice polytope  $\mathcal{P}_{R,L} \subset (\Lambda_{\alpha}^{\vee})_{\mathbb{Q}}$  is reflexive and its dual is the root lattice Weyl polytope  $\mathcal{WP}(\varphi_{n_L}) \subset (\Lambda_{\alpha})_{\mathbb{Q}}$ .*

In the next table, for each root system  $R$ , such that  $X_{R,L}$  is Gorenstein Fano, we give in the third column the Dynkin diagram of  $R^{\vee}$ , where blank circles  $\circ$  corresponding to elements in  $L$  and label  $J$  for elements in  $J_L$ . In the last column, we encode  $\varphi_{n_L} = \sum_{i \in I} a_i \omega_i$  as follow: on the Dynkin diagram of type  $R$ , if  $a_i \neq 0$  we put the coefficient  $a_i$  under the corresponding vertice. To compute  $\varphi_{n_L}$  we use the matrix:

$$((\omega_i, \omega_j^{\vee}))_{i,j \in I}$$

which is the inverse of the Cartan Matrix and computed in [OV90].



type( $G$ )	rank	Dynkin( $R^\vee$ ), $L$ and $J_L$	Dynkin( $R$ ) and $\varphi_{n_L}$
$A_n$	$n \geq 1$		
	$n \geq 2$		
	$n$ odd, $n \geq 3$		
	$n$ even, $n \geq 4$		
$B_n$	$n \geq 2$		
$C_n$	$n \geq 3$		
$D_n$	$n \geq 4$		
$E_6$	6		
$F_4$	4		
$G_2$	2		

We conclude with figures of some reflexive polytopes and their duals. For the type  $A_2$  (figure 9), we have two pairs: interior polytopes are  $\mathcal{P}_{R,L}$  with vertices in the weight lattice and duals are exterior polytopes in the root lattice. For the type  $B_2$  and  $L = \{1\}$ , in the figure 10, the polytope  $\mathcal{P}_{R,L}$  is the interior polytope in the weight lattice of  $C_2$  and its dual is in the root lattice of  $B_2$  (which is obtained from  $C_2$  by permutation of the simple roots). In dimension two, there is 16 reflexive

polygons (see for example [CLS11] p 382). Among these, we find five built from root systems.

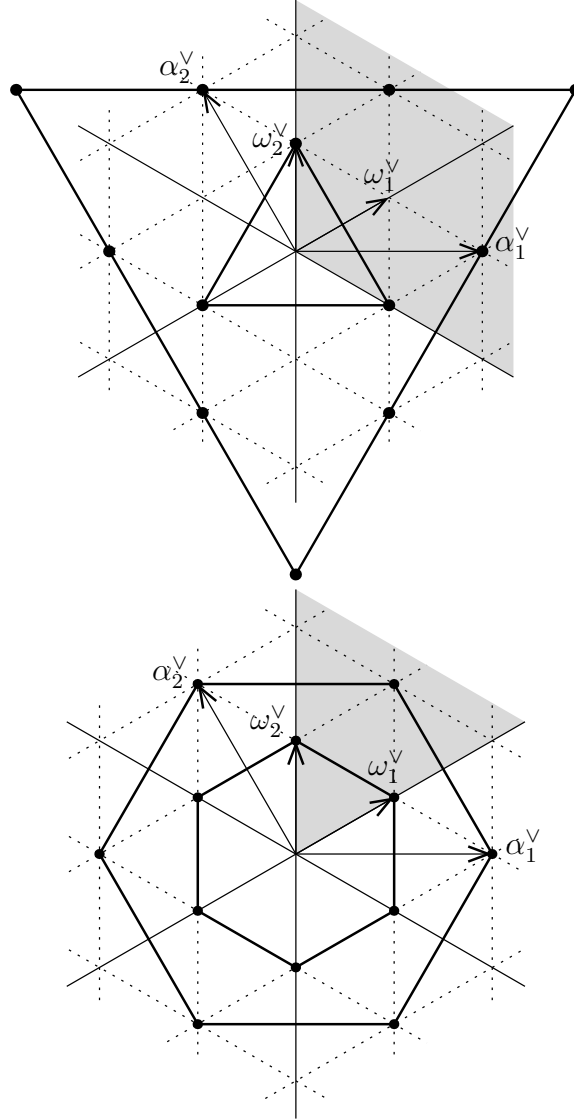

FIG. 9.

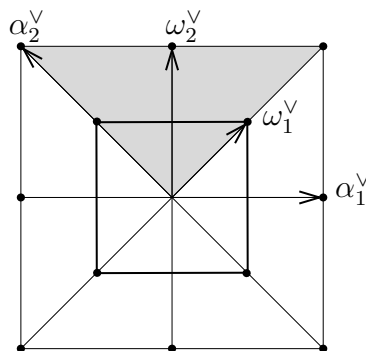

FIG. 10.

## REFERENCES

- [BaBl11] BATYREV, VICTOR AND BLUME, MARK, *The functor of toric varieties associated with Weyl chambers and Losev-Manin moduli spaces*, *Tohoku Math. J. (2)*, 63 (4), 2011 pp581–604.
- [Bou68] BOURBAKI, N., *Éléments de mathématique. Fasc. XXXIV. Groupes et algèbres de Lie. Chapitre IV: Groupes de Coxeter et systèmes de Tits. Chapitre V: Groupes engendrés par des réflexions. Chapitre VI: systèmes de racines*, French. Actualités Scientifiques et Industrielles, No. 1337, Hermann, Paris, 1968, 288 pp. (loose errata).
- [B68en] BOURBAKI, N., *Lie groups and Lie algebras. Chapters 4–6*, *Elements of Mathematics (Berlin)*. Translated from the 1968 French original by Andrew Pressley, Springer-Verlag, Berlin, 2002, xii+300pp.
- [DL94] DOLGACHEV, IGOR AND LUNTS, VALERY, *A character formula for the representation of a Weyl group in the cohomology of the associated toric variety*, *J. Algebra*, Vol. 168 (3), 1994, pp 741–772.
- [CLS11] COX, D., LITTLE, J.B. AND SCHENCK, H., *Toric varieties*, *Graduate Studies in Mathematics*, 124, AMS, 2011, xxiv+841 pages.
- [Kempf73] KEMPF ET AL. *Toroidal embeddings I* *Lectures notes in Math.* Vol. 339, Springer Verlag, 1973.
- [Kha17] KHARE, APOORVA, *Standard parabolic subsets of highest weight modules*, *Trans. Amer. Math. Soc.*, *Transactions of the American Mathematical Society*, 369 (4), 2017, pp 2363–2394.
- [Dab96] DABROWSKI, R., *On normality of the closure of a generic torus orbit in  $G/P$* , *Pacific J. Math.*, 172 (2), 1996, pp. 321–330.
- [GHLMP96] M. GECK, G. HISS, F. LÜBECK, G. MALLE, AND G. PFEIFFER. *CHEVIE – A system for computing and processing generic character tables for finite groups of Lie type, Weyl groups and Hecke algebras*. *Appl. Algebra Engrg. Comm. Comput.*, 7:175–210, 1996.
- [Mic2015] MICHEL, JEAN *The development version of the CHEVIE package of GAP3*, *J. of Algebra*, 435, 2015, pp. 308–336
- [MR17] <http://montagar.perso.math.cnrs.fr/WhichAreFano.zip>
- [Pro90] PROCESI, C., *The toric variety associated to Weyl chambers*, in *Mots*, Lang. Raison. Calc, Hermès, Parism 1990, pp. 153–161,
- [Sch97] MARTIN SCHÖNERT ET AL. *GAP – Groups, Algorithms, and Programming – version 3 release 4 patchlevel 4<sup>o</sup>*. Lehrstuhl D für Mathematik, Rheinisch Westfälische Technische Hochschule, Aachen, Germany, 1997.
- [St] W. A. Stein et al., *Sage Mathematics Software (Version 7.2)*, The Sage Development Team, 2016, <http://www.sagemath.org>.
- [VoKl85] VOSKRESENSKIĬ, V.E., KLYACHKO, A.A., *Toric Fano varieties and systems of roots*, *Izv. Akad. Nauk SSSR Ser. Mat.*, Vol. 48 (1984), No. 2, pp. 237–263. English version in *Math. USSR Izvestiya* Vol. 24 (1985), No. 2, pp. 237–263,
- [WZ17] WEI, YANGJIANG AND ZOU, YI MING, *Inverses of Cartan matrices of Lie algebras and Lie superalgebras*, *Linear Algebra Appl.*, Vol 521,(2017), pp. 283–298.

- [OV90] ONISHCHIK, A. L. AND VINBERG, È. B., *Lie groups and algebraic groups*, Springer Series in Soviet Mathematics, Translated from the Russian and with a preface by D. A. Leites, Springer-Verlag, Berlin.

Pierre-Louis Montagard  
Université de Montpellier  
IMAG  
UMR CNRS 5149  
Case courrier 051  
Place Eugène Bataillon  
34090 Montpellier – France  
pierre-louis.montagard@umontpellier.fr

Alvaro Rittatore  
Centro de Matemática  
Facultad de Ciencias  
Iguá 4225  
11400 Montevideo  
Uruguay  
alvaro@cmat.edu.uy