

HELICOIDAL MINIMAL SURFACES OF PRESCRIBED GENUS

DAVID HOFFMAN, MARTIN TRAIZET, AND BRIAN WHITE

ABSTRACT. For every genus g , we prove that $\mathbf{S}^2 \times \mathbf{R}$ contains complete, properly embedded, genus- g minimal surfaces whose two ends are asymptotic to helicoids of any prescribed pitch. We also show that as the radius of the \mathbf{S}^2 tends to infinity, these examples converge smoothly to complete, properly embedded minimal surfaces in \mathbf{R}^3 that are helicoidal at infinity. We prove that helicoidal surfaces in \mathbf{R}^3 of every prescribed genus occur as such limits of examples in $\mathbf{S}^2 \times \mathbf{R}$.

In 2005, Meeks and Rosenberg proved that the only complete, non flat, properly embedded minimal surface of genus zero and one end is the standard helicoid [MR05a]. Subsequently, Bernstein-Breiner [Ber11] and Meeks-Perez [MP15] proved that any complete, non flat, properly embedded minimal surface in \mathbf{R}^3 of finite genus g with one end must be asymptotic to a helicoid at infinity. We call such a surface a genus- g helicoid. Until 1993, the only known example was the helicoid itself. In that year, Hoffman, Karcher and Wei [HKW93] discovered a genus-one minimal surface asymptotic to a helicoid at infinity (see Figure 1, left), and numerical computations gave compelling evidence that it was embedded. Subsequently, Weber, Hoffman and Wolf proved existence of an embedded example, i.e., of a genus-one helicoid [WHW09]. In [HW08], Hoffman and White gave a different proof for the existence of a genus-one helicoid.

A genus-2 helicoid was computed numerically by the second author in 1993 while he was a postdoc in Amherst (see Figure 1, right). Helicoids of genus up to six have been computed by Schmies [Sch05] using the theoretical techniques developed by Bobenko [Bob98]. These surfaces were computed using the Weierstrass Representation and the period problem was solved numerically. However, there was no proof that the period problem could be solved for genus 2 or higher.

In this paper we prove:

Theorem 1. *For every g , there exist genus- g helicoids in \mathbf{R}^3 .*

To construct higher genus helicoids in \mathbf{R}^3 , we first construct helicoid-like minimal surfaces of prescribed genus in the Riemannian 3-manifold $\mathbf{S}^2 \times \mathbf{R}$, where \mathbf{S}^2 stands for a round sphere. This is achieved by a degree argument. Then we let the radius of the sphere \mathbf{S}^2 go to infinity and we prove that in the limit we get helicoids of prescribed genus in \mathbf{R}^3 . The delicate part in this limiting process is to ensure that the limit has the desired topology, in other words that the handles do not all drift away.

Date: April 6, 2013. Revised February, 2016.

2010 *Mathematics Subject Classification.* Primary: 53A10; Secondary: 49Q05, 53C42.

The research of the second author was partially supported by ANR-11-ISO1-0002. The research of the third author was supported by NSF grants DMS-1105330 and DMS 1404282.

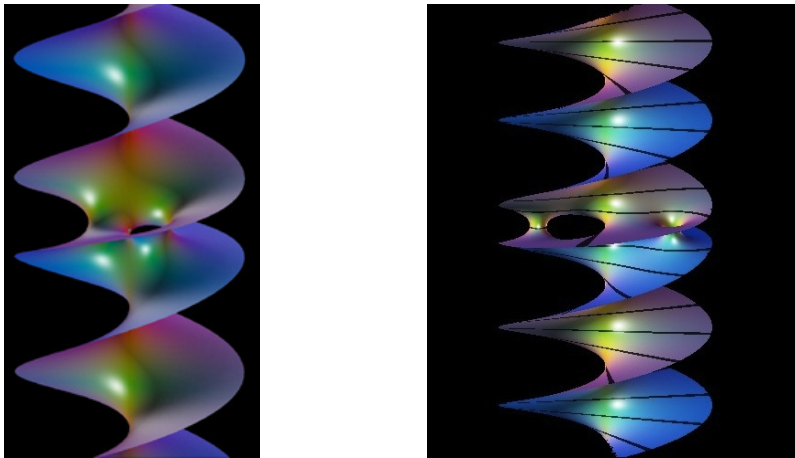

FIGURE 1. **Left:** A genus-one helicoid, computed by David Hoffman, Hermann Karcher and Fusheng Wei. **Right:** A genus-two helicoid, computed by Martin Traizet. Both surfaces were computed numerically using the Weierstrass representation, and the images were made with Jim Hoffman using visualization software he helped to develop.

The paper is divided into two parts. In part I, we construct helicoidal minimal surfaces in $\mathbf{S}^2 \times \mathbf{R}$, and we prove that they converge to helicoidal minimal surfaces in \mathbf{R}^3 as the radius goes to infinity. In part II, we prove that the limit has the desired topology by proving that, if we work with suitable helicoids of an even genus in $\mathbf{S}^2 \times \mathbf{R}$ and let the radius go to infinity, then exactly half of the handles drift away.

Parts I and II are in some ways independent of each other, and the methods used are very different. Of course, part II uses some properties of the $\mathbf{S}^2 \times \mathbf{R}$ surfaces obtained in part I, but otherwise it does not depend on the way in which those surfaces were obtained. We have stated those properties as they are needed in part II, so that part II can be read independently of part I.

CONTENTS

Part I: Genus-g Helicoids in $\mathbf{S}^2 \times \mathbf{R}$	3
1. Preliminaries	5
2. The Main Theorems	5
3. Positivity/Negativity of Surfaces at O	8
4. Y -surfaces	8
5. Periodic genus- g helicoids in $\mathbf{S}^2 \times \mathbf{R}$: theorem 2 for $h < \infty$	10
6. Adjusting the pitch of the helicoid	13
7. Eliminating jacobi fields by perturbing the metric	14
8. Rounding the curve Γ and the family of surfaces $t \mapsto S(t)$	17
9. Additional properties of the family $t \mapsto S(t)$	26
10. Counting the number of points in $Y \cap S(t)$	27
11. Counting minimal surfaces bounded by smooth curves	30

12. General results on existence of limits	32
13. Uniform Local Area Bounds in $\mathbf{S}^2 \times \mathbf{R}$	33
14. Nonperiodic genus- g helicoids in $\mathbf{S}^2 \times \mathbf{R}$: theorem 2 for $h = \infty$	35
15. Convergence to Helicoidal Surfaces in \mathbf{R}^3	36
16. The proof of theorem 3	48
17. Minimal surfaces in a thin hemispherical shell	50
18. Noncongruence Results	51
Part II: Genus-g Helicoids in \mathbf{R}^3	51
19. Preliminaries	52
20. The setup	53
21. Case 1: $p_1 \in (0, i)$	58
22. Case 2: $p_1 = 0$	69
23. Case 3: $p_1 = i$	71
Appendix A. Auxiliary results	78
References	85

Part I: Genus- g Helicoids in $\mathbf{S}^2 \times \mathbf{R}$

The study of complete, properly embedded minimal surfaces in $\Sigma \times \mathbf{R}$, where Σ is a complete Riemannian 2-manifold, was initiated by Harold Rosenberg in [Ros02]. The general theory of such surfaces was further developed by Meeks and Rosenberg in [MR05b]. In the case of $\mathbf{S}^2 \times \mathbf{R}$, if such a surface has finite topology, then either it is a union of horizontal spheres $\mathbf{S}^2 \times \{t\}$, or else it is conformally a connected, twice-punctured, compact Riemann surface, with one end going up and the other end going down [Ros02, Theorems 3.3, 4.2, 5.2]. In that same paper, Rosenberg described a class of such surfaces in $\mathbf{S}^2 \times \mathbf{R}$ that are very similar to helicoids in \mathbf{R}^3 , and hence are also called helicoids. They may be characterized as the complete, non-flat minimal surfaces in $\mathbf{S}^2 \times \mathbf{R}$ whose horizontal slices are all great circles. (See section 1 for a more explicit description of helicoids in $\mathbf{S}^2 \times \mathbf{R}$ and for a discussion of their basic properties.)

In part I of this paper, we prove the existence of properly embedded minimal surfaces in $\mathbf{S}^2 \times \mathbf{R}$ of prescribed finite genus, with top and bottom ends asymptotic to an end of a helicoid of any prescribed pitch. (The pitch of a helicoid in $\mathbf{S}^2 \times \mathbf{R}$ is defined in section 1. The absolute value of the pitch is twice the vertical distance between successive sheets of the helicoid. The sign of the pitch depends on the sense in which the helicoid winds about its axes.) Although the pitch of the helicoid to which the top end is asymptotic equals pitch of the helicoid to which the bottom is asymptotic, we do not know if these two helicoids coincide; one might conceivably be a vertical translate of the other. Each of the surfaces we produce contains a pair of antipodal vertical lines Z and Z^* (called axes of the surface) and a horizontal great circle X that intersects each of the axes. Indeed, for each of our surfaces, there is a helicoid whose intersection with the surface is precisely $X \cup Z \cup Z^*$.

For every genus, our method produces two examples that are not congruent to each other by any orientation-preserving isometry of $\mathbf{S}^2 \times \mathbf{R}$. The two examples are distinguished by their behavior at the origin O : one is “positive” at O and

the other is “negative” at O . (The positive/negative terminology is explained in section 3.) If the genus is odd, the two examples are congruent to each other by reflection μ_E in the totally geodesic cylinder consisting of all points equidistant from the two axes. If the genus is even, the two examples are not congruent to each other by any isometry of $\mathbf{S}^2 \times \mathbf{R}$, but each one is invariant under the reflection μ_E . The examples of even genus $2g$ are also invariant under $(p, z) \mapsto (\tilde{p}, z)$, where p and \tilde{p} are antipodal points in \mathbf{S}^2 , so their quotients under this involution are genus- g minimal surfaces in $\mathbf{RP}^2 \times \mathbf{R}$ with helicoidal ends.

For each genus g and for each helicoidal pitch, we prove that as the radius of the \mathbf{S}^2 tends to infinity, our examples converge subsequentially to complete, properly embedded minimal surfaces in \mathbf{R}^3 that are asymptotic to helicoids at infinity. The arguments in part II required to control the genus of the limit (by preventing too many handles from drifting away) are rather delicate. It is much easier to control whether the limiting surface has odd or even genus: a limit (as the radius of \mathbf{S}^2 tends to infinity) of “positive” examples must have even genus and a limit of “negative” examples must have odd genus. Such parity control is sufficient (without the delicate arguments of part II) to give a new proof of the existence of a genus-one helicoid in \mathbf{R}^3 . See the corollary to theorem 3 in section 2 for details.

Returning to our discussion of examples in $\mathbf{S}^2 \times \mathbf{R}$, we also prove existence of what might be called periodic genus- g helicoids. They are properly embedded minimal surfaces that are invariant under a screw motion of $\mathbf{S}^2 \times \mathbf{R}$ and that have fundamental domains of genus g . Indeed, our nonperiodic examples in $\mathbf{S}^2 \times \mathbf{R}$ are obtained as limits of the periodic examples as the period tends to infinity.

As mentioned above, all of our examples contain two vertical axes $Z \cup Z^*$ and a horizontal great circle $X \subset \mathbf{S}^2 \times \{0\}$ at height 0. Let Y be the great circle at height 0 such that X , Y , and Z meet orthogonally at a pair of points $O \in Z$ and $O^* \in Z^*$. All of our examples are invariant under 180° rotation about X , Y , and Z (or, equivalently, about Z^* : rotations about Z are also rotations about Z^*). In addition, the nonperiodic examples (and suitable fundamental domains of the periodic examples) are what we call “ Y -surfaces”. Intuitively, this means that they are ρ_Y -invariant (where ρ_Y is 180° rotation about Y) and that the handles (if there are any) occur along Y . The precise definition is that ρ_Y acts by multiplication by -1 on the first homology group of the surface. This property is very useful because it means that when we let the period of the periodic examples tend to infinity, the handles cannot drift away: they are trapped along Y , which is compact. In part II, when we need to control handles drifting off to infinity as we let the radius of the \mathbf{S}^2 tend to infinity, the Y -surface property means that the handles can only drift off in one direction (namely along Y).

Part I is organized as follows. In section 1, we present the basic facts about helicoids in $\mathbf{S}^2 \times \mathbf{R}$. In section 2, we state the main results. In section 3, we describe what it means for a surface to be positive or negative at O with respect to H . In section 4, we describe the general properties of Y -surfaces. In sections 5–11, we prove existence of periodic genus- g helicoids in $\mathbf{S}^2 \times \mathbf{R}$. In sections 12 and 13 we present general results we will use in order to establish the existence of limits. In section 14, we get nonperiodic genus- g helicoids as limit of periodic examples by letting the period tend to infinity. In section 15 and 16, we prove that as the radius of the \mathbf{S}^2 tends to infinity, our nonperiodic genus- g helicoids in $\mathbf{S}^2 \times \mathbf{R}$ converge to properly embedded, minimal surfaces in \mathbf{R}^3 with helicoidal ends.

1. PRELIMINARIES

Symmetries of $\mathbf{S}^2 \times \mathbf{R}$. Let $R > 0$ and $\mathbf{S}^2 = \mathbf{S}^2(R)$ be the sphere of radius R . Let C be a horizontal great circle in $\mathbf{S}^2 \times \mathbf{R}$ at height a , i.e., a great circle in the sphere $\mathbf{S}^2 \times \{a\}$ for some a . The union of all vertical lines through points in C is a totally geodesic cylinder. We let μ_C denote reflection in that cylinder: it is the orientation-reversing isometry of $\mathbf{S}^2 \times \mathbf{R}$ that leaves points in the cylinder fixed and that interchanges the two components of the complement. If we compose μ_C with reflection in the sphere $\mathbf{S}^2 \times \{a\}$, i.e., with the isometry

$$(p, z) \in \mathbf{S}^2 \times \mathbf{R} \mapsto (p, 2a - z),$$

we get an orientation-preserving involution ρ_C of $\mathbf{S}^2 \times \mathbf{R}$ whose fixed-point set is precisely C . Intuitively, ρ_C is 180° rotation about C .

Let L be a vertical line $\{p\} \times \mathbf{R}$ in $\mathbf{S}^2 \times \mathbf{R}$ and let L^* be the antipodal line, i.e., the line $\{p^*\} \times \mathbf{R}$ where p and p^* are antipodal points in \mathbf{S}^2 . Rotation through any angle θ about L is a well-defined isometry of $\mathbf{S}^2 \times \mathbf{R}$. If θ is not a multiple of 2π , then the fixed point set of the rotation is $L \cup L^*$. Thus any rotation about L is also a rotation about L^* . We let $\rho_L (= \rho_{L^*})$ denote the 180° rotation about L .

Helicoids in $\mathbf{S}^2 \times \mathbf{R}$. Let O and O^* be a pair of antipodal points in $\mathbf{S}^2 \times \{0\}$, and let Z and Z^* be the vertical lines in $\mathbf{S}^2 \times \mathbf{R}$ through those points. Let X and Y be a pair of great circles in $\mathbf{S}^2 \times \{0\}$ that intersect orthogonally at O and O^* . Let E be the equator in $\mathbf{S}^2 \times \{0\}$ with poles O and O^* , i.e., the set of points in $\mathbf{S}^2 \times \{0\}$ equidistant from O and O^* .

Fix a nonzero number κ and consider the surface

$$H = H_\kappa = \bigcup_{t \in \mathbf{R}} \sigma_{2\pi t, \kappa t} X,$$

where $\sigma_{\theta, v} : \mathbf{S}^2 \times \mathbf{R} \rightarrow \mathbf{S}^2 \times \mathbf{R}$ is the screw motion given by rotation by θ about Z (or, equivalently, about Z^*) together with vertical translation by v . We say that H is the *helicoid of pitch κ and axes $Z \cup Z^*$ that contains X* .

To see that H is a minimal surface, note that it is fibered by horizontal great circles. Let p be a point in H and let C be the horizontal great circle in H containing p . One easily checks that the involution ρ_C (180° rotation about C) maps H to H , reversing its orientation. It follows immediately that the mean curvature of H at p is 0. For if it were nonzero, it would point into one of the two components of $(\mathbf{S}^2 \times \mathbf{R}) \setminus H$. But then by the symmetry ρ_C (which interchanges the two components), it would also point into the other component, a contradiction.

Unlike helicoids in \mathbf{R}^3 , the helicoid H has two axes, Z and Z^* . Indeed, the reflection μ_E restricts to an orientation-reversing isometry of H that interchanges Z and Z^* .

The number κ is called the *pitch* of the helicoid: its absolute value is twice the vertical distance between successive sheets of H . Without loss of generality we will always assume that $\kappa > 0$. As κ tends to ∞ , the helicoid H_κ converges smoothly to the cylinder $X \times \mathbf{R}$, which thus could be regarded as a helicoid of infinite pitch.

2. THE MAIN THEOREMS

We now state our first main result in a form that includes the periodic case ($h < \infty$) and the nonperiodic case ($h = \infty$.) The reader may wish initially to ignore the periodic case. Here X and Y are horizontal great circles at height $z = 0$

that intersect each other orthogonally at points O and O^* , E is the great circle of points at height $z = 0$ equidistant from O and O^* , and Z and Z^* are the vertical lines passing through O and O^* .

Theorem 2. *Let H be a helicoid in $\mathbf{S}^2 \times \mathbf{R}$ that has vertical axes $Z \cup Z^*$ and that contains the horizontal great circle X . For each genus $g \geq 1$ and each height $h \in (0, \infty]$, there exists a pair M_+ and M_- of embedded minimal surfaces in $\mathbf{S}^2 \times \mathbf{R}$ of genus g with the following properties (where $s \in \{+, -\}$):*

- (1) *If $h = \infty$, then M_s has no boundary, it is properly embedded in $\mathbf{S}^2 \times \mathbf{R}$, and each of its two ends is asymptotic to H or to a vertical translate of H .*
- (2) *If $h < \infty$, then M_s is a smooth, compact surface-with-boundary in $\mathbf{S}^2 \times [-h, h]$. Its boundary consists of the two great circles at heights h and $-h$ that intersect H orthogonally at points in Z and in Z^* .*
- (3) *If $h = \infty$, then*

$$M_s \cap H = Z \cup Z^* \cup X.$$

If $h < \infty$, then

$$\text{interior}(M_s) \cap H = Z_h \cup Z_h^* \cup X,$$

where Z_h , and Z_h^ are the portions of Z and Z^* with $|z| < h$.*

- (4) *M_s is a Y -surface.*
- (5) *$M_s \cap Y$ contains exactly $2g + 2$ points.*
- (6) *M_+ and M_- are positive and negative, respectively, with respect to H at O .*
- (7) *If g is odd, then M_+ and M_- are congruent to each other by reflection μ_E in the cylinder $E \times \mathbf{R}$. They are not congruent to each other by any orientation-preserving isometry of $\mathbf{S}^2 \times \mathbf{R}$.*
- (8) *If g is even, then M_+ and M_- are each invariant under reflection μ_E in the cylinder $E \times \mathbf{R}$. They are not congruent to each other by any isometry of $\mathbf{S}^2 \times \mathbf{R}$.*

The positive/negative terminology in assertion (6) is explained in section 3, and Y -surfaces are defined and discussed in section 4.

Note that if $h < \infty$, we can extend M_s by repeated Schwarz reflections to get a complete, properly embedded minimal surface \widehat{M}_s that is invariant under the screw motion σ that takes H to H (preserving its orientation) and $\{z = 0\}$ to $\{z = 2h\}$. The intersection $\widehat{M}_s \cap H$ consists of Z , Z^* , and the horizontal circles $H \cap \{z = 2nh\}$, $n \in \mathbf{Z}$. The surfaces \widehat{M}_s are the periodic genus- g helicoids mentioned in the introduction.

2.1. Remark. Assertion (2) states (for $h < \infty$) that the boundary ∂M_s consists of two great circles that meet H orthogonally. Actually, we could allow ∂M_s to be any ρ_Y -invariant pair of great circles at heights h and $-h$ that intersect Z and Z^* . We have chosen to state theorem 2 for circles that meet the helicoid H orthogonally because when we extend M_s by repeated Schwarz reflections to get a complete, properly embedded surface \widehat{M} , that choice makes the intersection set $\widehat{M} \cap H$ particularly simple. In section 6, we explain why the choice does not matter: if the theorem is true for one choice, it is also true for any other choice. Indeed, in *proving* the $h < \infty$ case of theorem 2, it will be more convenient to let ∂M_s be the horizontal great circles $H \cap \{z = \pm h\}$ that lie in H . (Later, when we let $h \rightarrow \infty$ to get nonperiodic genus- g helicoids in $\mathbf{S}^2 \times \mathbf{R}$, the choice of great circles ∂M_s plays no role in the proofs.)

2.2. Remark. Theorem 2 remains true if the round metric on \mathbf{S}^2 is replaced by any metric that has positive curvature, that is rotationally symmetric about the poles O and O^* , and that is symmetric with respect to reflection in the equator of points equidistant from O and O^* . (In fact the last symmetry is required only for the assertions about μ_E symmetry.) No changes are required in any of the proofs.

In the nonperiodic case ($h = \infty$) of theorem 2, we do not know whether the two ends of M_s are asymptotic to opposite ends of the same helicoid. Indeed, it is possible that the top end is asymptotic to a H shifted vertically by some amount $v \neq 0$; the bottom end would then be asymptotic to H shifted vertically by $-v$. Also, we do not know whether M_+ and M_- must be asymptotic to each other, or to what extent the pair $\{M_+, M_-\}$ is unique.

Except for the noncongruence assertions, the proof of theorem 2 holds for all helicoids H including $H = X \times \mathbf{R}$, which may be regarded as a helicoid of infinite pitch. (When $H = X \times \mathbf{R}$ and $h = \infty$, theorem 2 was proved by Rosenberg in section 4 of [Ros02] by completely different methods.) When $X = H \times \mathbf{R}$, the noncongruence assertions break down: see section 18. The periodic (i.e., $h < \infty$) case of theorem 2 is proved at the end of section 5, assuming theorem 5.1, whose proof is a consequence of the material in subsequent sections. The nonperiodic ($h = \infty$) case is proved in section 14.

Our second main result lets us take limits as the radius of the \mathbf{S}^2 tends to infinity. For simplicity we only deal with the nonperiodic case ($h = \infty$) here.¹

Theorem 3. *Let R_n be a sequence of radii tending to infinity. For each n , let $M_+(R_n)$ and $M_-(R_n)$ be genus- g surfaces in $\mathbf{S}^2(R_n) \times \mathbf{R}$ satisfying the list of properties in theorem 2, where H is the helicoid of pitch 1 and $h = \infty$. Then, after passing to a subsequence, the $M_+(R_n)$ and $M_-(R_n)$ converge smoothly on compact sets to limits M_+ and M_- with the following properties:*

- (1) M_+ and M_- are complete, properly embedded minimal surfaces in \mathbf{R}^3 that are asymptotic to the standard helicoid $H \subset \mathbf{R}^3$.
- (2) If $M_s \neq H$, then $M_s \cap H = X \cup Z$ and M_s has sign s at O with respect to H .
- (3) M_s is a Y -surface.
- (4) $\|M_s \cap Y\| = 2\|M_s \cap Y^+\| + 1 = 2 \text{ genus}(M_s) + 1$.
- (5) If g is even, then M_+ and M_- each have genus at most $g/2$. If g is odd, then $\text{genus}(M_+) + \text{genus}(M_-)$ is at most g .
- (6) The genus of M_+ is even. The genus of M_- is odd.

Here if A is a set, then $\|A\|$ denotes the number of elements of A .

Theorem 3 is proved in section 16.

As mentioned earlier, theorem 3 gives a new proof of the existence of genus-one helicoids in \mathbf{R}^3 :

Corollary. *If $g = 1$ or 2 , then M_+ has genus 0 and M_- has genus 1.*

The corollary follows immediately from statements (5) and (6) of theorem 3.

In part II, we prove existence of helicoidal surfaces of arbitrary genus in \mathbf{R}^3 :

Theorem 4. *Let M_+ and M_- be the limit minimal surfaces in \mathbf{R}^3 described in theorem 3, and suppose that g is even. If $g/2$ is even, then M_+ has genus $g/2$. If $g/2$ is odd, then M_- has genus $g/2$.*

¹An analogous theorem is true for the periodic case ($h < \infty$).

The sign here is crucial: if $g/2$ is even, then M_- has genus strictly less than $g/2$, and if $g/2$ is odd, then M_+ has genus strictly less than $g/2$. (These inequalities follow immediately from statements (5) and (6) of theorem 3.)

3. POSITIVITY/NEGATIVITY OF SURFACES AT O

In this section, we explain the positive/negative terminology used in theorem 2. Let H be a helicoid that has axes $Z \cup Z^*$ and that contains X . The set

$$H \setminus (X \cup Z \cup Z^*)$$

consists of four components that we will call quadrants. The axes Z and Z^* are naturally oriented, and we choose an orientation of X allowing us to label the components of $X \setminus \{O, O^*\}$ as X^+ and X^- . We will refer to the quadrant bounded by X^+ , Z^+ and $(Z^*)^+$ and the quadrant bounded by X^- , Z^- , and $(Z^*)^-$ as the *positive quadrants* of H . The other two quadrants are called the *negative quadrants*. We orient Y so that the triple (X, Y, Z) is positively oriented at O , and let H^+ denote the the component of the complement of H that contains Y^+ .

Consider an embedded minimal surface S in $\mathbf{S}^2 \times \mathbf{R}$ such that in some open set U containing O ,

$$(1) \quad (\partial S) \cap U = (X \cup Z) \cap U.$$

If S and the two positive quadrants of $H \setminus (X \cup Z)$ are tangent to each other at O , we say that S is *positive* at O . If S and the two negative quadrants of $H \setminus (X \cup Z)$ are tangent to each other at O , we say that S is *negative* at O . (Otherwise the sign of S at O with respect to H is not defined.)

Now consider an embedded minimal surface M in $\mathbf{S}^2 \times \mathbf{R}$ such that

$$(2) \quad \begin{array}{l} \text{The origin } O \text{ is an interior point of } M, \text{ and} \\ M \cap H \text{ coincides with } X \cup Z \text{ in some neighborhood of } O. \end{array}$$

We say that M is positive or negative at O with respect to H according to whether $M \cap H^+$ is positive or negative at O .

Positivity and negativity at O^* is defined in exactly the same way.

3.1. Remark. A surface S satisfying (1) is positive (or negative) at O if and only if $\mu_E S$ is positive (or negative) at O^* , where μ_E denotes reflection in the totally geodesic cylinder consisting of all points equidistant from Z and Z^* . Similarly, a surface M satisfying (2) is positive (or negative) at O with respect to H if and only if $\mu_E M$ is positive (or negative) at O^* with respect to H . (If this is not clear, note that $\mu_E(H^+) = H^+$ and that $\mu_E(Q) = Q$ for each quadrant Q of H .)

4. Y -SURFACES

As discussed in the introduction, the surfaces we construct will be Y -surfaces. In this section, we define “ Y -surface” and prove basic properties of Y -surfaces.

4.1. Definition. Suppose N is a Riemannian 3-manifold that admits an order-two rotation ρ_Y about a geodesic Y . An orientable surface S in N is called a *Y -surface* if ρ_Y restricts to an orientation-preserving isometry of S and if

$$(3) \quad \rho_Y \text{ acts on } H_1(S, \mathbf{Z}) \text{ by multiplication by } -1.$$

The following proposition shows that the definition of a Y -surface is equivalent to two other topological conditions.

4.2. Proposition. *Suppose that S is an open, orientable Riemannian 2-manifold of finite topology, that $\rho : S \rightarrow S$ is an orientation-preserving isometry of order two, and that S/ρ is connected. Then the following are equivalent:*

- (a) ρ acts by multiplication by -1 on the first homology group $H_1(S, \mathbf{Z})$.
- (b) the quotient S/ρ is topologically a disk.
- (c) S has exactly $2 - \chi(S)$ fixed points of ρ , where $\chi(S)$ is the Euler characteristic of S .

Note that proposition 4.2 is intrinsic in nature. It does not require that the orientation-preserving automorphism ρ be a reflection in an ambient geodesic Y . Proposition 4.2 is easily proved using a ρ -invariant triangulation of S whose vertices include the fixed points of ρ ; details may be found in [HW08].

4.3. Corollary. *Let S be an open, orientable Y -surface such that S/ρ_Y is connected. Let k be the number of fixed points of $\rho_Y : S \rightarrow S$.*

- (i) *The surface S has either one or two ends, according to whether k is odd or even.*
- (ii) *If $k = 0$, then S is the union of two disks.*
- (iii) *If $k > 0$, then S is connected, and the genus of S is $(k - 2)/2$ if k is even and $(k - 1)/2$ if k is odd.*

In particular, S is a single disk if and only if $k = 1$.

Proof of Corollary 4.3. Since S/ρ_Y is a disk, it has one end, and thus S has either one or two ends. The Euler characteristic of S is $2c - 2g - e$, where c is the number of connected components, g is the genus, and e is the number of ends. Thus by proposition 4.2(b),

$$(4) \quad 2 - k = 2c - 2g - e.$$

Hence k and e are congruent modulo 2. Assertion (i) follows immediately. (Figure 2 shows two examples of assertion (i).)

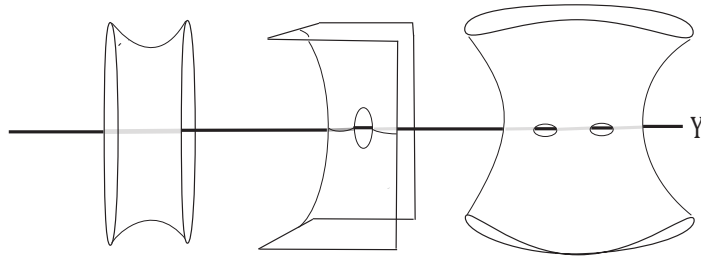

FIGURE 2. **Right:** A Y -surface of genus two. The number of fixed points of ρ_Y (180° rotation around Y) is even (equal to six) and the number of boundary components is two. **Center:** A Y -surface of genus one. The number of fixed points of ρ_Y is odd (equal to three) and there is a single boundary component. **Left:** This annular surface A is not a Y -surface. The rotation ρ_Y acts as the identity on $H_1(A, \mathbf{Z})$, not as multiplication by -1 .

Note that if S has more than one component, then since S/ρ_Y is a disk, in fact S must have exactly two components, each of which must be a disk. Furthermore, ρ_Y interchanges the two disks, so that ρ_Y has no fixed points in S , i.e., $k = 0$.

Conversely, suppose $k = 0$. Then $e = 2$ by Assertion (i), so from (4) we see that

$$2c = 2g + 4.$$

Hence $2c \geq 4$ and therefore $c \geq 2$, i.e., S has two or more components. But we have just shown that in that case S has exactly two components, each of which is a disk. This completes the proof of Assertion (ii).

Now suppose that $k > 0$. Then as we have just shown, S is connected, so (4) becomes $k = 2g + e$, or

$$(5) \quad g = \frac{k - e}{2}$$

This together with Assertion (i) gives Assertion (iii). \square

4.4. Remark. To apply proposition 4.2 and corollary 4.3 to a compact manifold M with non-empty boundary, one lets $S = M \setminus \partial M$. The number of ends of S is equal to the number of boundary components of M .

4.5. Proposition. *If S is a Y -surface in N and if U is an open subset of S such that U and $\rho_Y U$ are disjoint, then U has genus 0.*

Proof. Note that we can identify U with a subset of S/ρ_Y . Since S is a Y -surface, S/ρ_Y has genus 0 (by proposition 4.2) and therefore U has genus 0. \square

5. PERIODIC GENUS- g HELICOIDS IN $\mathbf{S}^2 \times \mathbf{R}$: THEOREM 2 FOR $h < \infty$

Let $0 < h < \infty$. Recall that we are trying to construct a minimal surface M in $\mathbf{S}^2 \times [-h, h]$ such that

$$\text{interior}(M) \cap H = Z_h \cup Z_h^* \cup X$$

(where Z_h and Z_h^* are the portions of Z and Z^* where $|z| < h$) and such that ∂M is a certain pair of circles at heights h and $-h$. Since such an M contains Z_h , Z_h^* , and X , it must (by the Schwarz reflection principle) be invariant under ρ_Z (which is the same as ρ_{Z^*}) and under ρ_X , the 180° rotations about Z and about X . It follows that M is invariant under ρ_Y , the composition of ρ_Z and ρ_X . In particular, if we let $S = \text{interior}(M) \cap H^+$ be the portion of the interior² of M in H^+ , then

$$M = \overline{S \cup \rho_Z S} = \overline{S \cup \rho_X S}.$$

Thus to construct M , it suffices to construct S . Note that the boundary of S is $Z_h \cup Z_h^* \cup X$ together with a great semicircle C in $\overline{H^+} \cap \{z = h\}$ and its image $\rho_Y C$ under ρ_Y . Let us call that boundary Γ_C . (See Figure 3.) Thus we wish to construct embedded minimal surface S in H^+ having specified topology and having boundary $\partial S = \Gamma_C$. Note we need S to be ρ_Y -invariant; otherwise Schwarz reflection in Z and Schwarz reflection in X would not produce the same surface.

We will prove existence by counting surfaces mod 2. Suppose for the moment that the curve Γ_C is nondegenerate in the following sense: if S is a smooth embedded, minimal, Y -surface in H^+ with boundary Γ_C , then S has no nonzero ρ_Y -invariant jacobi fields that vanish on Γ_C . For each $g \geq 0$, the number of such surfaces S of

²It will be convenient for us to have S be an open manifold, because although S is a smooth surface, its closure has corners.

genus g turns out to be even. Of course, for the purposes of proving existence, this fact is not useful, since 0 is an even number. However, if instead of considering all Y -surfaces of genus g , we consider only those that are positive (or those that are negative) at O , then the number of such surfaces turns out to be odd, and therefore existence follows.

For the next few sections, we fix a helicoid H and we fix an h with $0 < h < \infty$. Our goal is to prove the following theorem:

5.1. Theorem. *Let $0 < h < \infty$, let C be a great semicircle in $\overline{H^+} \cap \{z = h\}$ joining Z to Z^* , and let Γ_C be the curve given by*

$$\Gamma_C = Z_h \cup Z_h^* \cup C \cup \rho_Y C,$$

where $Z_h = Z \cap \{|z| \leq h\}$ and $Z^* = Z^* \cap \{|z| \leq h\}$.

For each sign $s \in \{+, -\}$ and for each $n \geq 1$, there exists an open, embedded minimal Y -surface $S = S_s$ in $H^+ \cap \{|z| < h\}$ such that $\partial S = \Gamma_C$, such that $Y^+ \cap S$

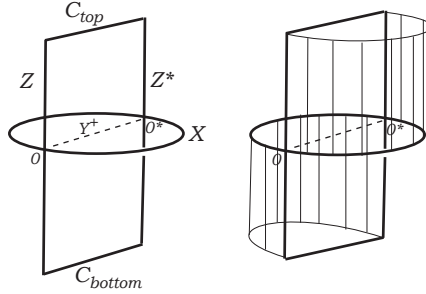

FIGURE 3. **The boundary curve Γ_C .** We depict $\mathbf{S}^2 \times \mathbf{R}$ in these illustrations as \mathbf{R}^3 with each horizontal $\mathbf{S}^2 \times \{z\}$ represented as horizontal plane via stereographic projection, with one point of the sphere at infinity. Here, that point is the antipodal point of the midpoint of the semicircle Y^+ . **Right:** For ease of illustration, we have chosen the reference helicoid H to be the vertical cylinder $X \times \mathbf{R}$, and the semicircle $C = C_{\text{top}}$ to meet H orthogonally. The geodesics X , Z and Z^* divide H into four components, two of which are shaded. The helicoid H divides $\mathbf{S}^2 \times \mathbf{R}$ into two components. The component H^+ is the interior of the solid cylinder bounded by H . **Left:** The boundary curve $\Gamma = \Gamma_C$ consists of the great circle X , two vertical line segments on the axes $Z \cup Z^*$ of height $2h$ and two semicircles in $(\mathbf{S}^2 \times \{\pm h\}) \cap H^+$. Note that Γ has ρ_Y symmetry. We seek a ρ_Y -invariant minimal surface in H^+ that has boundary Γ_C and has all of its topology concentrated along Y^+ . That is, we want a Y -surface as defined in section 4 with the properties established in proposition 4.2. According to theorem 5.1, there are in fact two such surfaces for every positive genus.

contains exactly n points, and such that S is positive³ at O if $s = +$ and negative at O if $s = -$.

If n is even, there is such a surface that is invariant under reflection μ_E in the totally geodesic cylinder $E \times \mathbf{R}$.

Before proving theorem 5.1, let us show that it implies the periodic case of theorem 2 of section 2:

5.2. Proposition. *Theorem 5.1 implies theorem 2 in the periodic case $h < \infty$.*

Proof. Let C be the great semicircle in $\overline{H^+} \cap \{z = h\}$ that has endpoints on $Z \cup Z^*$ and that meets H orthogonally at those endpoints. First suppose n is even, and let S_s for $s \in \{+, -\}$ be the surfaces given by theorem 5.1. Let M_s be the surface obtained by Schwarz reflection from S_s :

$$M_s = \overline{S_s \cup \rho_Z S_s} = \overline{S_s \cup \rho_X S_s},$$

(The second equality holds because S_s is ρ_Y -invariant and $\rho_Z \circ \rho_Y = \rho_X$.)

By lemma 5.3 below, M_s is a smoothly embedded minimal surface. Clearly it is ρ_Y -invariant, it lies in $\mathbf{S}^2 \times [-h, h]$, its interior has the desired intersection with H , it has the indicated sign at O , it has μ_E symmetry, and its boundary is the desired pair of horizontal circles. We claim that M_s is a Y -surface. To see this, note that since S_s is a Y -surface, the quotient S_s/ρ_Y is topologically a disk by proposition 4.2. The interior of M_s/ρ_Y is two copies of S_s/ρ_Y glued along a common boundary segment. Thus the interior of M_s/ρ_Y is also topologically a disk, and therefore M_s is a Y -surface by proposition 4.2.

Note that $M_s \cap Y$ has $2n + 2$ points: the n points in $S_s \cap Y^+$, an equal number of points in $\rho_Z S_s \cap Y^-$, and the two points O and O^* . Thus by corollary 4.3, M_s has genus n . Since n is an arbitrary even number, this completes the proof for even genus, except for assertion (8), the assertion that M_+ and M_- are not congruent.

Now let n be odd, and let S_+ be the surface given by theorem 5.1. By lemma 5.4 below, S_+ is negative at O^* , which implies that $\mu_E(S_+)$ is negative at O . In this case, we choose our S_- to be $\mu_E(S_+)$. Exactly as when n is even, we extend S_\pm by Schwarz reflection to get M_\pm . As before, the M_\pm are Y -surfaces of genus n . The proof that they have the required properties is exactly as in the case of even n , except for the statement that M_+ and M_- are not congruent by any orientation-preserving isometry of $\mathbf{S}^2 \times \mathbf{R}$.

It remains only to prove the statements about noncongruence of M_+ and M_- . Those statements (which we never use) are proved in section 18. \square

The proof above used the following two lemmas:

5.3. Lemma. *If S is a ρ_Y -invariant embedded minimal surface in H^+ with boundary Γ and with $Y \cap S$ a finite set, then the Schwarz-extended surface*

$$M = \overline{S \cup \rho_Z S} = \overline{S \cup \rho_X S}.$$

is smoothly embedded everywhere.

Proof. One easily checks that if q is a corner of Γ other than O or O^* , then the tangent cone to S at q is a multiplicity-one quarter plane. Thus the tangent cone to M at q is a multiplicity-one halfplane, which implies that M is smooth at q

³Positivity and negativity of S at O were defined in section 3.

by Allard's boundary regularity theorem [All75]. (In fact, the classical boundary regularity theory [Hil69] suffices here.)

Let B be an open ball centered at O small enough that B contains no points of $Y \cap S$. Now $S \cap B$ is a Y -surface, so by corollary 4.3(ii), it is topologically the union of two disks. It follows that $M \cap B$ is a disk, so M is a branched minimal immersion at O by [Gul76]. But since M is embedded, in fact M is unbranched. \square

5.4. Lemma. *Let $S \subset H^+$ be a Y -surface with $\partial S = \Gamma$. Then the signs of S at O and O^* agree or disagree according to whether the number of points of $Y \cap S$ is even or odd.*

Proof. Let \widehat{S} be the geodesic completion of S . We can identify \widehat{S} with $\overline{S} = S \cup \partial S$, except that $O \in \overline{S}$ corresponds to two points in \widehat{S} , and similarly for O^* . Note that the number of ends of S is equal to the number of boundary components of $\partial \widehat{S}$.

By symmetry, we may assume that the sign of S at O is $+$. Then at O , Z^+ is joined in $\partial \widehat{S}$ to X^+ and Z^- is joined to X^- . If the sign of S at O^* is also $+$, then the same pairing occurs at O^* , from which it follows that $\partial \widehat{S}$ has two components and therefore that S has two ends. If the sign of S at O^* is $-$, then the pairings are crossed, so that $\partial \widehat{S}$ has only one component and therefore S has only one end. Thus S has two ends or one end according to whether the signs of S at O and O^* are equal or not. The lemma now follows from corollary 4.3, according to which the number of ends of S is two or one according to whether the number of points of $Y \cap S$ is even or odd. \square

6. ADJUSTING THE PITCH OF THE HELICOID

Theorem 5.1 of section 5 asserts that the curve Γ_C bounds various minimal surfaces in H^+ . In that theorem, $C = \Gamma \cap \{z = h\}$ is allowed to be any semicircle in $\overline{H^+} \cap \{z = h\}$ with endpoints in $Z \cup Z^*$. In this section, we will show that in order to prove theorem 5.1, it is sufficient to prove it for the special case where C is a semicircle in the helicoid H .

6.1. Theorem. *[Special case of theorem 5.1] Let $0 < h < \infty$ and let C be the semicircle in $H \cap \{z = h\}$ joining Z to Z^* such that C and X^+ lie in the same component of $H \setminus (Z \cup Z^*)$. For each sign $s \in \{+, -\}$ and for each $n \geq 1$, there exists an open embedded minimal Y -surface $S = S_s$ in $H^+ \cap \{|z| < h\}$ such that*

$$\partial S = \Gamma_C := Z_h \cup Z_h^* \cup C \cup \rho_Y C,$$

such that $Y^+ \cap S$ contains exactly n points, and such that S is positive at O if $s = +$ and negative at O if $s = -$.

If n is even, there is such a surface that is invariant under reflection μ_E in the totally geodesic cylinder $E \times \mathbf{R}$.

We will prove that theorem 6.1, a special case of theorem 5.1, is in fact equivalent to it:

6.2. Proposition. *Theorem 6.1 implies theorem 5.1.*

Proof of Proposition 6.2. Let H be a helicoid and let C be a great semicircle in $\overline{H^+} \cap \{z = h\}$. We may assume that C does not lie in H , as otherwise there is nothing to prove. Therefore the interior of the semicircle C lies in H^+ . Now increase (or decrease) the pitch of H to get a one-parameter family of helicoids $H(t)$ with $0 \leq t \leq 1$ such that

- (1) $H(1) = \overline{H}$,
- (2) $C \subset \overline{H(t)^+}$ for all $t \in [0, 1]$,
- (3) $C \subset H(0)$.

Claim. *Suppose S is an open, ρ_Y -invariant, embedded minimal surface bounded by Γ_C with $S \cap Y^+$ nonempty. If S is contained in $H(0)^+$, then it is contained in $H(t)^+$ for all $t \in [0, 1]$. Furthermore, in that case the sign of S at O with respect to $H(t)$ does not depend on t .*

Proof of claim. Let T be the set of $t \in [0, 1]$ for which S is contained in $\overline{H(t)^+}$. Clearly T is a closed set. We claim that T is also open relative to $[0, 1]$. For suppose that $t \in T$, and thus that $S \subset \overline{H(t)^+}$. Now S is not contained in $H(t)$ since $S \cap Y^+$ is nonempty. Thus by the strong maximum principle and the strong boundary maximum principle, S cannot touch $H(t)$, nor is \overline{S} tangent to $H(t)$ at any points of Γ_C other than its corners.

At the corners O and O^* , S and $H(\tau)$ are tangent. However, the curvatures of H and $M := \overline{S \cup \rho_Y S}$ differ from each other⁴ at O , and also at O^* . It follows readily that t is in the interior of T relative to $[0, 1]$. Since T is open and closed in $[0, 1]$ and is nonempty, $T = [0, 1]$. This proves the first assertion of the claim. The second follows by continuity. \square

By the claim, if theorem 6.1 is true for Γ_C and $H(0)$, then theorem 5.1 is true for $H = H(1)$ and Γ_C . This completes the proof of proposition 6.2. \square

7. ELIMINATING JACOBI FIELDS BY PERTURBING THE METRIC

Our proof involves counting minimal surfaces mod 2. Minimal surfaces with nontrivial jacobi fields tend to throw off such counts. (A nontrivial jacobi field is a nonzero normal jacobi field that vanishes on the boundary.) Fortunately, if we fix a curve Γ in a 3-manifold, then a generic Riemannian metric on the 3-manifold will be “bumpy” (with respect to Γ) in the following sense: Γ will not bound any minimal surfaces with nontrivial jacobi fields. Thus instead of working with the standard product metric on $\mathbf{S}^2 \times \mathbf{R}$, we will use a slightly perturbed bumpy metric and prove theorem 6.1 for that perturbed metric. By taking a limit of surfaces as the perturbation goes to 0, we get the surfaces whose existence is asserted in theorem 6.1 for the standard metric. In this section, we explain how to perturb the metric to make it bumpy, and how to take the limit as the perturbation goes to 0.

In what class of metrics should we make our perturbations? The metrics should have ρ_X and ρ_Z symmetry so that we can do Schwarz reflection, ρ_Y symmetry so that the notion of Y -surface makes sense, and μ_E -symmetry so that the conclusion of theorem 6.1 makes sense. It is convenient to use metrics for which the helicoid H and the spheres $\{z = \pm h\}$ are minimal, because we will need the region $N = \overline{H^+} \cap \{|z| \leq h\}$ to be weakly mean-convex. We will also need to have an isoperimetric inequality hold for minimal surfaces in N , which is equivalent (see remark 7.3) to the nonexistence of any smooth, closed minimal surfaces in N . Finally, at one point (see the last sentence in section 11) we will need the two bounded components of

⁴Recall that if two minimal surfaces in a 3-manifold are tangent at a point, then the intersection set near the point is like the zero set of a homogeneous harmonic polynomial. In particular, it consists of $(n + 1)$ curves crossing through the point, where n is the degree of contact of the two surfaces at the point. Near O , the intersection of M and H coincides with $X \cup Z$, so their order of contact at O is exactly one.

$H \setminus \Gamma$ to be strictly stable, so we restrict ourselves to metrics for which they are strictly stable.

The following theorem (together with its corollary) is theorem 6.1 with the standard metric on $\mathbf{S}^2 \times \mathbf{R}$ replaced by a suitably bumpy metric in the class of metrics described above, and with the conclusion strengthened to say that Γ_C bounds an odd number of surfaces with the desired properties:

7.1. Theorem. *Let $\Gamma = \Gamma_C$ be the curve in theorem 6.1:*

$$\Gamma = Z_h \cup Z_h^* \cup C \cup \rho_Y C,$$

where C is the semicircle in $H \cap \{z = h\}$ joining Z to Z^* such that C and X^+ lie in the same component of $H \setminus (Z \cup Z^*)$. Let G be the group of isometries of $\mathbf{S}^2 \times \mathbf{R}$ generated by ρ_X , ρ_Y , $\rho_Z = \rho_{Z^*}$, and μ_E . Let γ be a smooth, G -invariant Riemannian metric on $\mathbf{S}^2 \times \mathbf{R}$ such that

- (1) the helicoid H and the horizontal spheres $\{z = \pm h\}$ are γ -minimal surfaces.
- (2) the two bounded components of $H \setminus \Gamma$ are strictly stable (as γ -minimal surfaces).
- (3) the region $N := \overline{H^+} \cap \{|z| \leq h\}$ contains no smooth, closed, embedded γ -minimal surface.
- (4) the curve Γ does not bound any embedded γ -minimal Y -surfaces in $\overline{H^+} \cap \{|z| \leq h\}$ with nontrivial ρ_Y -invariant jacobi fields.

For each nonnegative integer n and each sign $s \in \{+, -\}$, let

$$\mathcal{M}^s(\Gamma, n) = \mathcal{M}_\gamma^s(\Gamma, n)$$

denote the set of embedded, γ -minimal Y -surfaces S in $\overline{H^+} \cap \{|z| \leq h\}$ bounded by Γ such that $S \cap Y^+$ has exactly n points and such that S has sign s at O . Then the number of surfaces in $\mathcal{M}^s(\Gamma, n)$ is odd.

7.2. Corollary. *Under the hypotheses of the theorem, if n is even, then the number of μ_E -invariant surfaces in $\mathcal{M}^s(\Gamma, n)$ is odd.*

Proof of corollary. Let n be even. By lemma 5.4, if $S \in \mathcal{M}^s(\Gamma, n)$, then S also has sign s at O^* , from which it follows that $\mu_E(S) \in \mathcal{M}^s(\Gamma, n)$. Thus the number of non- μ_E -invariant surfaces in $\mathcal{M}^s(\Gamma, n)$ is even because such surfaces come in pairs (S being paired with $\mu_E S$). By the theorem, the total number of surfaces in $\mathcal{M}^s(\Gamma, n)$ is odd, so therefore the number of μ_E -invariant surfaces must also be odd. \square

7.3. Remark. Hypothesis (1) of theorem 7.1 implies that the compact region $N := \overline{H^+} \cap \{|z| \leq h\}$ is γ -mean-convex. It follows (see [Whi09, §2.1 and §5]) that condition (3) is equivalent to the following condition:

- (3') There is a finite constant c such that $\text{area}(\Sigma) \leq c \text{length}(\partial\Sigma)$ for every γ -minimal surface Σ in N .

Furthermore, the proof of theorem 2.3 in [Whi09] shows that for any compact set N , the set of Riemannian metrics satisfying (3') is open, with a constant $c = c_\gamma$ that depends upper-semicontinuously on the metric⁵.

⁵As explained in [Whi09], for any metric γ , we can let c_γ be the supremum (possibly infinite) of $|V|/|\delta V|$ among all 2-dimensional varifolds V in N with $|\delta V| < \infty$, where $|V|$ is the mass of V and $|\delta V|$ is its total first variation measure. The supremum is attained by a varifold V_γ with mass $|V_\gamma| = 1$. Suppose $\gamma(i) \rightarrow \gamma$. By passing to a subsequence, we may assume that the $V_{\gamma(i)}$ converge

7.4. Proposition. *Suppose theorem 7.1 is true. Then theorem 6.1 is true.*

Proof. Let \mathcal{G}_1 be the space of all smooth, G -invariant Riemannian metrics γ on $\mathbf{S}^2 \times \mathbf{R}$ that satisfy hypothesis (1) of the theorem. Let $\widehat{\mathcal{G}}$ be the subset consisting of those metrics $\gamma \in \mathcal{G}_1$ such that also satisfy hypotheses (2) and (3) of theorem 7.1, and let \mathcal{G} be the set of metrics that satisfy all the hypotheses of the theorem.

We claim that the standard product metric γ belongs to $\widehat{\mathcal{G}}$. Clearly it is G -invariant and satisfies hypothesis (1). Note that each bounded component of $H \setminus \Gamma$ is strictly stable, because it is contained in one of the half-helicoidal components of $H \setminus (Z \cup Z^*)$ and those half-helicoids are stable (vertical translation induces a positive jacobian field). Thus γ satisfies the strict stability hypothesis (2). It also satisfies hypothesis (3) because if Σ were a closed minimal surface in N , then the height function z would attain a maximum value, say a , on Σ , which implies by the strong maximum principle that the sphere $\{z = a\}$ would be contained in Σ , contradicting the fact that $\Sigma \subset N \subset \overline{H^+}$. This completes the proof that the standard product metric γ belongs to $\widehat{\mathcal{G}}$.

By lemma 7.5 below, a generic metric in \mathcal{G}_1 satisfies the bumpiness hypothesis (4) of theorem 7.1. Since $\widehat{\mathcal{G}}$ is an open subset of \mathcal{G}_1 (see remark 7.3), it follows that a generic metric in $\widehat{\mathcal{G}}$ satisfies the bumpiness hypothesis. In particular, this means that \mathcal{G} is a dense subset of $\widehat{\mathcal{G}}$.

Since the standard metric γ is in $\widehat{\mathcal{G}}$, there is a sequence γ_i of metrics in \mathcal{G} that converge smoothly to γ . Fix a nonnegative integer n and a sign s . By theorem 7.1, $\mathcal{M}_{\gamma_i}^s(\Gamma, n)$ contains at least one surface S_i . If n is even, we choose S_i to be μ_E -invariant, which is possible by corollary 7.2.

By remark 7.3,

$$(6) \quad \limsup_i \frac{\text{area}_{\gamma_i}(S_i)}{\text{length}_{\gamma_i}(\partial S_i)} \leq c_\gamma$$

where c_γ is the constant in remark 7.3 for the standard product metric γ . Since

$$\text{length}_{\gamma_i}(\partial S_i) = \text{length}_{\gamma_i}(\Gamma) \rightarrow \text{length}_\gamma(\Gamma) < \infty,$$

we see from (6) that the areas of the S_i are uniformly bounded.

Let

$$M_i = \overline{S_i \cup \rho_Z S_i}$$

be obtained from S_i by Schwarz reflection. Of course the areas of the M_i are also uniformly bounded. Using the Gauss-Bonnet theorem, the minimality of the M_i , and the fact that the sectional curvatures of $\mathbf{S}^2 \times \mathbf{R}$ are bounded, it follows that

$$(7) \quad \sup_i \int_{M_i} \beta(M_i, \cdot) dA < \infty,$$

weakly to a varifold V . Under weak convergence, mass is continuous and total first variation measure is lower semicontinuous. Thus

$$c_\gamma \geq \frac{|V|}{|\delta V|} \geq \limsup \frac{|V_{\gamma(i)}|}{|\delta V_{\gamma(i)}|} = \limsup c_{\gamma(i)}.$$

This proves that the map $\gamma \mapsto c_\gamma \in (0, \infty]$ is upper semicontinuous, and therefore also that the set of metrics γ for which $c_\gamma < \infty$ is an open set. (The compactness, continuity, and lower semicontinuity results used here are easy and standard, and are explained in the appendix to [Whi09]. See in particular [Whi09, §7.5].)

where $\beta(M_i, p)$ is the square of the norm of the second fundamental form of M_i at the point p .

The total curvature bound (7) implies (see [Whi87, theorem 3]) that after passing to a further subsequence, the M_i converge smoothly to an embedded minimal surface M , which implies that the S_i converge uniformly smoothly to a surface S in N with $\partial S = \Gamma$ and with $M = \overline{S \cup \rho_Y S}$. The smooth convergence $M_i \rightarrow M$ implies that $S \in \mathcal{M}_\gamma^s(\Gamma, n)$, where γ is the standard product metric. Furthermore, if n is even, then S is μ_E -invariant. This completes the proof of theorem 6.1 (assuming theorem 7.1). \square

7.5. Lemma. *Let \mathcal{G}_1 be the set of smooth, G -invariant metrics γ on $\mathbf{S}^2 \times \mathbf{R}$ such that the helicoid H and the spheres $\{z = \pm h\}$ are γ -minimal. For a generic metric γ in \mathcal{G}_1 , the curve Γ bounds no embedded, ρ_Y -invariant, γ -minimal surfaces with nontrivial ρ_Y -invariant jacobi fields.*

Proof. By the bumpy metrics theorem [Whi17b], a generic metric γ in \mathcal{G}_1 has the property

- (*) The pair of circles $H \cap \{z = \pm h\}$ bounds no embedded γ -minimal surface in $H \cap \{|z| \leq h\}$ with a nontrivial jacobi field.

Thus it suffices to prove that if γ has the property (*), and if $S \subset N$ is an embedded, ρ_Y -invariant, γ -minimal surface with boundary Γ , then S has no nontrivial ρ_Y -invariant jacobi field.

Suppose to the contrary that S had such a nontrivial jacobi field v . Then v would extend by Schwarz reflection to a nontrivial jacobi field on $M := \overline{S \cup \rho_Y S}$, contradicting (*). \square

8. ROUNDING THE CURVE Γ AND THE FAMILY OF SURFACES $t \mapsto S(t)$

Our goal for the next few sections is to prove theorem 7.1. The proof is somewhat involved. It will be completed in section 11. From now until the end of section 11, we fix a helicoid H in $\mathbf{S}^2 \times \mathbf{R}$ and a height h with $0 < h < \infty$. We let $\Gamma = \Gamma_C$ be the curve in theorem 7.1. We also fix a Riemannian metric on $\mathbf{S}^2 \times \mathbf{R}$ that satisfies the hypotheses of theorem 7.1. In particular, in sections 8–11, every result is with respect to that Riemannian metric. In reading those sections, it may be helpful to imagine that the metric is the standard product metric. (In fact, for the purposes of proving theorem 2, the metric may as well be arbitrarily close to the standard product metric.) Of course, in carrying out the proofs in sections 8–11, we must take care to use no property of the metric other than those enumerated in theorem 7.1.

Note that theorem 7.1 is about counting minimal surfaces mod 2. The mod 2 number of embedded minimal surfaces of a given topological type bounded by a smoothly embedded, suitably bumpy curve is rather well understood. For example, if the curve lies on the boundary of a strictly convex set in \mathbf{R}^3 , the number is 1 if the surface is a disk and is 0 if not. Of course the curve Γ in theorem 7.1 is neither smooth nor embedded, so to take advantage of such results, we will round the corners of Γ to make a smooth embedded curve, and we will use information about the mod 2 number of various surfaces bounded by the rounded curve to deduce information about mod 2 numbers of various surfaces bounded by the original curve Γ .

In this section, we define the notion of a “rounding”. A rounding of Γ is a one-parameter family $t \in (0, \tau] \mapsto \Gamma(t)$ of smooth embedded curves (with certain properties) that converge to Γ as $t \rightarrow 0$. Now if Γ were smooth and bumpy, then by the implicit function theorem, any smooth minimal surface $S(0)$ bounded by Γ would extend uniquely to a one-parameter family $t \in [0, \tau'] \mapsto S(t)$ of minimal surfaces with $\partial S(t) \equiv \Gamma(t)$ (for some possibly smaller $\tau' \in (0, \tau]$.)

It is natural to guess that this is also the case even in our situation, when Γ is neither smooth nor embedded. In fact, we prove that the guess is correct⁶. The proof is still based on the implicit function theorem, but the corners make the proof significantly more complicated. However, the idea of the proof is simple: we project the rounded curve $\Gamma(t)$ to a curve in the surface

$$M := \overline{S \cup \rho_Z S}$$

by the nearest point projection. We already have a minimal surface bounded by that projected curve: it bounds a portion $\Omega(t)$ of M . Now we smoothly isotope the projected curve back to $\Gamma(t)$, and use the implicit function theorem to make a corresponding isotopy through minimal surfaces of $\Omega(t)$ to the surface $S(t)$ we want. Of course we have to be careful to verify that we do not encounter nontrivial jacobian fields on the way.

We also prove that, roughly speaking, the surfaces $S(t)$ (for the various S 's bounded by Γ) account for *all* the minimal Y -surfaces bounded by $\Gamma(t)$ when t is sufficiently small. The precise statement (theorem 9.2) is slightly more complicated because the larger the genus of the surfaces, the smaller one has to choose t .

Defining roundings, proving the existence of the associated one-parameter families $t \mapsto S(t)$ of minimal surfaces as described above, and proving basic properties of such families take up the rest of this section and the following section. Once we have those tools, the proof of theorem 7.1 is not so hard: it is carried out in section 10.

To avoid losing track of the big picture, the reader may find it helpful initially to skip sections 8.10–8.14 (the proof of theorem 8.8) as well as the proofs in section 9, and then to read section 10, which contains the heart of the proof of theorem 7.1 and therefore also (see remark 10.8) of the periodic case of theorem 2.

8.1. Lemma. *Suppose that S a minimal embedded Y -surface in $N = \overline{H^+} \cap \{|z| \leq h\}$ with $\partial S = \Gamma$. Let*

$$V(S, \epsilon) = \{p \in \mathbf{S}^2 \times \mathbf{R} : \text{dist}(p, S) < \epsilon\}.$$

For all sufficiently small $\epsilon > 0$, the following hold:

- (1) *if $p \in V(S, \epsilon)$, then there is a unique point $\pi(p)$ in $\overline{S \cup \rho_Z S}$ nearest to p .*
- (2) *if S' is a ρ_Y -invariant minimal surface in $\overline{V(S, \epsilon)}$ with $\partial S' = \Gamma$, and if S' is smooth except possibly at the corners of Γ , then $S' = S$.*

Proof of Lemma 8.1. Assertion (1) holds (for sufficiently small ϵ) because $M := \overline{S \cup \rho_Z S}$ is a smooth embedded manifold-with-boundary.

Suppose assertion (2) fails. Then there is a sequence of minimal Y -surfaces $S_n \subset \overline{V(S, \epsilon_n)}$ with $\partial S_n = \Gamma$ such that $S_n \neq S$ and such that $\epsilon_n \rightarrow 0$. Let M_n be

⁶The correctness of the guess can be viewed as a kind of bridge theorem. Though it does not quite follow from the bridge theorems in [Sma87] or in [Whi94a, Whi94b], we believe the proofs there could be adapted to our situation. However, the proof here is shorter and more elementary than those proofs. (It takes advantage of special properties of our surfaces.)

the closure of $S_n \cap \rho_Z S_n$ or (equivalently) of $S_n \cap \rho_X S_n$. (Note that $\rho_Z S_n = \rho_X S_n$ by the ρ_Y -invariance of S_n .) Then M_n is a minimal surface with boundary $\partial M_n = \partial M$, M_n is smooth away from Y and from the corners of Γ , and

$$\max_{p \in M_n} \text{dist}(p, M) \rightarrow 0.$$

Since M is a smooth, embedded manifold with nonempty boundary, this implies that the convergence $M_n \rightarrow M$ is smooth by the extension of Allard's boundary regularity theorem in [Whi16, 6.1].

A *normal graph* of $f : S \rightarrow \mathbf{R}$ over a hypersurface S in a Riemannian manifold is the hypersurface $\{\exp_p(f(p)n(p)) \mid p \in S\}$, where $n(p)$ is a unit normal vector field on $S \subset N$ and \exp_p is the exponential mapping at p . From the previous paragraph, it follows that for all sufficiently large n , M_n is the normal graph of a function $f_n : M \rightarrow \mathbf{R}$ with $f_n|_\Gamma = 0$ such that $f_n \rightarrow 0$ smoothly. But then

$$\frac{f_n}{\|f_n\|_0}$$

converges (after passing to a subsequence) to a nonzero jacobian field on S that vanishes on $\partial S = \Gamma$, contradicting the assumption (hypothesis (4) of theorem 7.1) that the Riemannian metric is bumpy with respect to Γ . \square

8.2. Roundings of Γ . Let $t_0 > 0$ be less than half the distance between any two corners of Γ . For t satisfying $0 < t \leq t_0$, we can form from Γ a smoothly embedded ρ_Y -invariant curve $\Gamma(t)$ in the portion of H with $|z| \leq h$ as follows:

- (1) If q is a corner of Γ other than O or O^* , we replace $\Gamma \cap \mathbf{B}(q, t)$ by a smooth curve in $H \cap \mathbf{B}(q, t)$ that has the same endpoints as $\Gamma \cap \mathbf{B}(q, t)$ but that is otherwise disjoint from $\Gamma \cap \mathbf{B}(q, t)$.
- (2) If $q = O$ or $q = O^*$ we replace $\Gamma \cap \mathbf{B}(q, t)$ by two smoothly embedded curves in H that have the same endpoints as $\Gamma \cap \mathbf{B}(q, t)$ but that are otherwise disjoint from $\Gamma \cap \mathbf{B}(q, t)$. See Figures 4 and 5.

Note that $\Gamma(t)$ lies in the boundary of ∂N of the region $N = \overline{H^+} \cap \{|z| \leq h\}$.

8.3. Definition. Suppose $\Gamma(t) \subset H$ is a family of smooth embedded ρ_Y -invariant curves created from Γ according to the recipe above. Suppose we do this in such a way that that for each corner q of Γ , the curve

$$(8) \quad (1/t)(\Gamma(t) - q)$$

converges smoothly to a smooth, embedded planar curve Γ' as $t \rightarrow 0$. Then we say that the family $\Gamma(t)$ is a *rounding* of Γ .

8.4. Remark. Since we are working in $\mathbf{S}^2 \times \mathbf{R}$ with some Riemannian metric, it may not be immediately obvious what we mean by translation and by scaling in definition 8.3. However, there are various ways to make sense of it. For example, by the Nash embedding theorem, we can regard $\mathbf{S}^2 \times \mathbf{R}$ with the given Riemannian metric as embedded isometrically in some Euclidean space. In that Euclidean space, the expression (8) is well defined, and its limit as $t \rightarrow 0$ lies in the 3-dimensional tangent space (at q) to $\mathbf{S}^2 \times \mathbf{R}$, which is of course linearly isometric to \mathbf{R}^3 .

8.5. Remark. In definition 8.3, note that if the corner q is O or O^* , then Γ' consists of two components, and Γ' coincides with a pair of perpendicular lines outside a disk of radius 1 about the intersection of those lines. In this case, Γ' is the boundary

of two regions in the plane: one region is connected, and the other region (the complement of the connected region) consists of two connected components. We refer to each of these regions as a **rounded quadrant pair**. If q is a corner other than O or O^* , then Γ' consists of a single curve. In this case, Γ' bounds a planar region which, outside of a disk, coincides with a quadrant of the plane. We call such a region a **rounded quadrant**.

8.6. The existence of bridged approximations to S . We will assume until further notice that $\Gamma \subset H$ bounds an embedded minimal Y -surface S in $N = \overline{H^+} \cap \{|z| \leq h\}$. As in the previous section we define $M = \overline{S} \cup \rho_Z \overline{S}$. For $p \in \mathbf{S}^2 \times \mathbf{R}$, let $\pi(p) = \pi_M(p)$ be the point in M closest to p , provided that point is unique. Thus the domain of π is the set of all points in $\mathbf{S}^2 \times \mathbf{R}$ such that there is a unique nearest point in M . Since M is a smooth embedded manifold-with-boundary, the domain of π contains M in its interior.

Consider a rounding $\Gamma(t)$ of Γ with $t \in [0, t_0]$. By replacing t_0 by a smaller value, we may assume that for all $t \in [0, t_0]$, the curve $\Gamma(t)$ is in the interior of the domain of π and $\pi(\Gamma(t))$ is a smooth embedded curve in M . It follows that $\Gamma(t)$ is the normal graph of a function

$$\phi_t : \pi(\Gamma(t)) \rightarrow \mathbf{R}.$$

(Here normal means normal to M .) We let $\Omega(t)$ be the domain in M bounded by $\pi(\Gamma(t))$.

8.7. Remark. Suppose that S is positive at O , i.e., that it is tangent to the positive quadrants of H (namely the quadrant bounded by X^+ and Z^+ and the quadrant bounded by X^- and Z^- .) Note that O is in $\Omega(t)$ if and only if $\Gamma(t) \cap \mathbf{B}(O, t)$ lies in

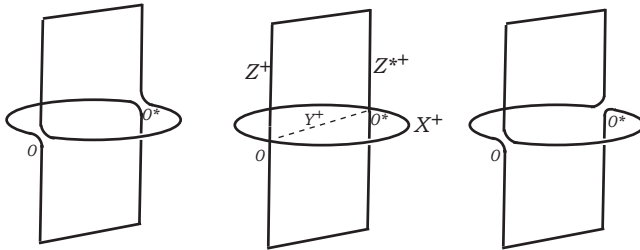

FIGURE 4. Rounding the corners of Γ . **Center:** The boundary curve Γ as illustrated in Figure 3. **Left and Right:** Desingularizations of Γ . The corners at O and O^* are removed, following the conditions (1) and (2) of 8.2. In both cases we have desingularized near O by joining X^+ to Z^+ and X^- to Z^- . In the language of Definition 10.1, both desingularizations are *positive at O* . On the left, the rounding is also *positive at O^** . On the right, the rounding is *negative at O^** . Note that when the signs of the rounding agree at O and O^* , as they do on the left, the rounded curve has two components; when the signs are different, as on the right, the rounded curve is connected.

the *negative* quadrants of H , or, equivalently, if and only if $\Gamma(t) \cap \mathbf{B}(O, t)$ connects Z^+ to X^- and Z^- to X^+ . See figure 5.

8.8. Theorem. *There exists a $\tau > 0$ and a smooth one-parameter family $t \in (0, \tau] \mapsto f_t$ of functions*

$$f_t : \Omega(t) \rightarrow \mathbf{R}$$

with the following properties:

- (1) *The normal graph $S(t)$ of f_t is a Y -nongenerate, minimal embedded Y -surface with boundary $\Gamma(t)$,*
- (2) *$\|f_t\|_0 + \|Df_t\|_0 \rightarrow 0$ as $t \rightarrow 0$,*
- (3) *$S(t)$ converges smoothly to S as $t \rightarrow 0$ except possibly at the corners of S ,*
- (4) *$S(t)$ lies in $\overline{H^+}$.*

Later (see theorem 9.1) we will prove that for small t , the surfaces $S(t)$ have a very strong uniqueness property. In particular, given S , the rounding $t \mapsto \Gamma(t)$, and any sufficiently small $\tau > 0$, there is a unique family $t \in (0, \tau] \rightarrow S(t)$ having the indicated properties.

8.9. Remark. Assertion (4) of the theorem follows easily from the preceding assertions, provided we replace τ by a suitable smaller number. To see this, note by the smooth convergence $S(t) \rightarrow S$ away from corners, each point of $S(t) \cap H^-$ must lie within distance ϵ_n of the corners of S , where $\epsilon_n \rightarrow 0$. By the implicit function theorem, each corner q of S has a neighborhood $U \subset \mathbf{S} \times [-h, h]$ that is foliated by minimal surfaces, one of which is $\overline{M} \cap U$. For t sufficiently small, the set of points of $S(t) \cap H^-$ that are near q will be contained entirely in U , which violates the maximum principle unless $S(t) \cap H^-$ is empty.

Idea of the proof of theorem 8.8. (The details will take up the rest of section 8.) The rounding is a one-parameter family of curves $\Gamma(t)$. We extend the one-parameter family to a two-parameter family $\Gamma(t, s)$ (with $0 \leq s \leq 1$) in such a way that $\Gamma(t, 1) = \Gamma(t)$ and $\Gamma(t, 0) = \pi(\Gamma(t))$. Now $\Gamma(t, 0)$ trivially bounds a minimal Y -surface that is a normal graph over $\Omega(t)$, namely $\Omega(t)$ itself (which is the normal graph of the zero function). We then use the implicit function theorem to get existence for all (t, s) with t sufficiently small of a minimal embedded Y -surface $S(t, s)$ with boundary $\Gamma(t, s)$. Then $t \mapsto S(t, 1)$ will be the desired one-parameter family of surfaces.

8.10. Definition. For $0 \leq t < t_0$, each $\Gamma(t)$ is the normal graph over $\pi(\Gamma(t))$ of a function $\phi_t : \pi(\Gamma(t)) \rightarrow \mathbf{R}$. For $0 \leq s \leq 1$, define

$$(9) \quad \Gamma(t, s) := \text{graph } s\phi_t.$$

Note that $\pi(\Gamma(t, s)) = \Gamma(t, 0)$.

8.11. Proposition. *There is a $\tau > 0$ and a smooth two-parameter family*

$$(t, s) \in (0, \tau] \times [0, 1] \mapsto S(t, s)$$

of Y -nondegenerate, minimal embedded Y -surfaces such that each $S(t, s)$ has boundary $\Gamma(t, s)$ and is the normal graph of a function $f_{t,s} : \Omega(t) \rightarrow \mathbf{R}$ such that

$$\|f_{t,s}\|_0 + \|Df_{t,s}\|_0 \rightarrow 0$$

as $t \rightarrow 0$. The convergence $f_{t,s} \rightarrow 0$ as $t \rightarrow 0$ is smooth away from the corners of S .

Theorem 8.8 follows from proposition 8.11 by setting $S(t) := S(t, 1)$. (See remark 8.9.)

Proof of proposition 8.11. Fix a $\eta > 0$ and a $\tau > 0$ and consider the following subsets of the domain $D := (0, \tau] \times [0, 1]$:

- (1) the relatively closed set A of all $(t, s) \in D$ such that $\Gamma(t, s)$ bounds a minimal embedded Y -surface that is the normal graph of a function from $\Omega(t) \rightarrow \mathbf{R}$ with Lipschitz constant $\leq \eta$.
- (2) the subset B of A consisting of all $(t, s) \in D$ such that $\Gamma(t, s)$ bounds a minimal embedded Y -surface that is Y -nondegenerate and that is the normal graph of a function from $\Omega(t)$ to \mathbf{R} with Lipschitz constant $< \eta$.
- (3) the subset C of A consisting of all $(t, s) \in D$ such that there is exactly one function whose Lipschitz constant is $\leq \eta$ and whose normal graph is a minimal embedded Y -surface with boundary $\Gamma(t, s)$.

By proposition 8.12 below, we can choose η and τ so that these three sets are equal: $A = B = C$. Clearly the set A is a relatively closed subset of $(0, \tau] \times [0, 1]$. Also, A is nonempty since it contains $(0, \tau] \times \{0\}$. (This is because $\Gamma(t, 0)$ is the boundary of the minimal Y -surface $\Omega(t)$, which is the normal graph of the zero function on $\Omega(t)$). By the implicit function theorem, the set B is a relatively open subset of $(0, \tau] \times [0, 1]$.

Since $A = B = C$ is nonempty and since it is both relatively closed and relatively open in $(0, \tau] \times [0, 1]$, we must have

$$A = B = C = (0, \tau] \times [0, 1].$$

For each $(t, s) \in (0, \tau] \times [0, 1] = C$, let $f_{t,s} : \Omega(t) \rightarrow \mathbf{R}$ be the unique function with Lipschitz constant $\leq \eta$ whose normal graph is a minimal embedded Y -surface $S(t, s)$ with boundary $\Gamma(t, s)$. Since $B = C$, in fact $f_{t,s}$ has Lipschitz constant $< \eta$ and $S(t, s)$ is Y -nondegenerate. By the Y -nondegeneracy and the implicit function theorem, $S(t, s)$ depends smoothly on (t, s) . Also,

$$(10) \quad \|f_{t,s}\|_0 + \|Df_{t,s}\|_0 \rightarrow 0$$

as $t \rightarrow 0$ by proposition 8.12 below. Finally, the smooth convergence $S(t, s) \rightarrow S$ away from corners follows from (10) by standard elliptic PDE. \square

8.12. Proposition. *There is an $\eta > 0$ with the following property. Suppose S_n is a sequence of minimal embedded Y -surfaces with $\partial S_n = \Gamma(t_n, s_n)$ where $t_n \rightarrow 0$ and $s_n \in [0, 1]$. Suppose also that each S_n is the normal graph of a function*

$$f_n : \Omega(t_n) \rightarrow \mathbf{R}$$

with Lipschitz constant $\leq \eta$. Then

- (1) $\|f_n\|_0 + \|Df_n\|_0 \rightarrow 0$. (In particular, $\text{Lip}(f_n) < \eta$ for all sufficiently large n .)
- (2) S_n is Y -nondegenerate for all sufficiently large n ,
- (3) If g_n is a function with Lipschitz constant $\leq \eta$ and if the graph of g_n is a minimal embedded Y -surface, then $g_n = f_n$ for all sufficiently large n .
- (4) If Σ_n is a sequence of minimal embedded Y -surfaces such that $\partial \Sigma_n = \partial S_n$ and such that $\Sigma_n \subset V(S, \epsilon_n)$ where $\epsilon_n \rightarrow 0$, then $\Sigma_n = S_n$ for all sufficiently large n .

Proof of proposition 8.12. By lemma 8.1, there is an $\epsilon > 0$ such that S is the only embedded minimal Y -surface in $V(S, \epsilon)$ with boundary Γ . Choose $\eta > 0$ small enough that if $f : S \rightarrow \mathbf{R}$ is Lipschitz with Lipschitz constant $\leq \eta$ and if $f|_{\Gamma} = 0$, then the normal graph of f lies in $V(S, \epsilon)$. In particular, if the graph of f is a minimal embedded Y -surface, then $f = 0$.

Since the f_n have a common Lipschitz bound η , they converge subsequentially to a Lipschitz function $f : S \rightarrow \mathbf{R}$. By the Schauder estimates, the convergence is smooth away from the corners of Γ , so the normal graph of f is minimal. Thus by choice of η , $f = 0$. This proves that

$$\|f_n\|_0 \rightarrow 0.$$

Let

$$L = \limsup \|Df_n\|_0.$$

We must show that $L = 0$. By passing to a subsequence, we can assume that the limsup is a limit, and we can choose a sequence of points $p_n \in S_n \setminus \partial M_n = S_n \setminus \Gamma(t_n, s_n)$ such that

$$\lim |Df_n(p_n)| = L.$$

By passing to a further subsequence, we can assume that the p_n converge to a point $q \in S$. If q is not a corner of S , then $f_n \rightarrow 0$ smoothly near q , which implies that $L = 0$.

Thus suppose q is a corner point of S , that is, one of the corners of Γ . Let $R_n = \text{dist}(p_n, q)$. Now translate S_n , Ω_n , Y , and p_n by $-q$ and dilate by $1/R_n$ to get $S(t)'$, Ω'_n , Y'_n and p'_n . Note that $S(t)'$ is the normal graph over Ω'_n of a function f'_n where the $\|Df'_n\|_0$ are bounded (independently of n).

By passing to a subsequence, we may assume that the Ω'_n converges to a planar region Ω' , which must be one of the following:

- (1) A quadrant
- (2) a rounded quadrant.
- (3) a quadrant pair.
- (4) a rounded quadrant pair.
- (5) an entire plane.

(If q is O or O^* , then (3), (4), and (5) occurs according to whether t_n/R_n tends to 0, to a finite nonzero limit, or to infinity. If q is one of the other corners, then (1) or (2) occurs according to whether t_n/R_n tends to 0 or not.) We may also assume that the f'_n converge to a Lipschitz function $f : \Omega' \rightarrow \mathbf{R}$ and that the convergence is smooth away from the origin. Furthermore, there is a point $p \in \Omega'$ with

$$(11) \quad |p| = 1 \text{ and } |Df(p)| = L.$$

Suppose first that Ω' is a plane, which means that q is O or O^* , and thus that Y' is the line that intersects the plane of Ω' orthogonally. Since S' is a minimal graph over Ω' , S' must also be a plane (by Bernstein's theorem). Since Y intersects each $S(t)$ perpendicularly, Y' must intersect S' perpendicularly. Thus S' is a plane parallel to Ω' , so $Df' \equiv 0$. In particular, $L = 0$ as asserted.

Thus we may suppose that $\partial\Omega'$ (which is also $\partial S'$) is nonempty.

By Schwartz reflection, we can extend S' to a surface S^\dagger such that ∂S^\dagger is a compact subset of the plane P containing $\partial S'$ and such that S^\dagger has only one end, which is a Lipschitz graph over that plane. Thus the end is either planar or

catenoidal. It cannot be catenoidal since it contains rays. Hence the end is planar, which implies that

$$\lim_{x \rightarrow \infty} f(x) = 0.$$

But then $f \equiv 0$ by the maximum principle, so $Df \equiv 0$, and therefore $L = 0$ by (11). This completes the proof that $\|Df_n\|_0 \rightarrow 0$ and thus the proof of assertion (1).

For the proofs of assertions (2)–(4), it is convenient to make the following observation:

8.13. Claim. *Suppose that $p_n \in S_n \setminus \partial S_n$ and that $\text{dist}(p_n, \partial S_n) \rightarrow 0$. Translate S_n by $-p_n$ and dilate by $1/\text{dist}(p_n, \partial S_n)$ to get a surface S'_n . Then a subsequence of the S'_n converges to one of the following planar regions:*

- a quadrant,
- a rounded quadrant,
- a quadrant pair,
- a rounded quadrant pair, or
- a halfplane.

The claim follows immediately from the definitions (and the fact that $\|Df_n\| \rightarrow 0$) so we omit the proof.

Next we show assertion (2) of proposition 8.12: that S_n is Y -nondegenerate for all sufficiently large n . In fact, we prove somewhat more:

8.14. Claim. *Suppose u_n is an eigenfunction of the Jacobi operator on S_n with eigenvalue λ_n , normalized so that*

$$\|u_n\|_0 = \max |u_n(\cdot)| = \max u_n(\cdot) = 1.$$

Suppose also that the λ_n are bounded. Then (after passing to a subsequence) the S_n converge smoothly on compact sets to an eigenfunction u on S with eigenvalue $\lambda = \lim_n \lambda_n$.

(With slightly more work, one could prove that for every k , the k th eigenvalue of the Jacobi operator on S_n converges to the k th eigenvalue of the Jacobi operator on S . However, we do not need that result.)

Proof. By passing to a subsequence, we can assume that the λ_n converge to a limit λ , and that the u_n converge smoothly away from the corners of S to a solution of

$$Ju = -\lambda u$$

where J is the Jacobi operator on S . To prove the claim, it suffices to show that u does not vanish everywhere, and that u extends continuously to the corners of S .

Since u is bounded, that u extends continuously to the corners is a standard removal-of-singularities result. (One way to see it is as follows. Extend u by reflection to the smooth manifold-with-boundary $M = \bar{S} \cup \rho_Z \bar{S}$. Now u solves $\Delta u = \phi u$ for a certain smooth function ϕ on M . Let v be the solution of $\Delta v = \phi v$ on M with $v|_{\partial M} = 0$ given by the Poisson formula. Then v is continuous on M and smooth away from a finite set (the corners of Γ). Away from the corners of M , $u - v$ is a bounded harmonic function that vanishes on ∂M . But isolated singularities of bounded harmonic functions are removable, so $u - v \equiv 0$.)

To prove that u does not vanish everywhere, let p_n be a point at which u_n attains its maximum:

$$u_n(p_n) = 1 = \max_{S_n} |u_n(\cdot)|.$$

By passing to a subsequence, we can assume that the p_n converge to a point $p \in \overline{S}$. We assert that $p \notin \partial S$. For suppose $p \in \partial S$. Translate⁷ S_n by $-p_n$ and dilate by

$$c_n := \frac{1}{\text{dist}(p_n, \partial S_n)} = \frac{1}{\text{dist}(p_n, \Gamma(t_n, s_n))}$$

to get S'_n . Let u'_n be the eigenfunction on S'_n corresponding to u_n . Note that u'_n has eigenvalue λ_n/c_n^2 .

We may assume (after passing to a subsequence) that the S'_n converge to one of the planar regions S' listed in lemma 8.13. The convergence $S'_n \rightarrow S_n$ is smooth except possibly at the corner (if there is one) of S' .

By the smooth convergence of S'_n to S' , the u'_n converge subsequentially to a jacobi field u' on S' that is smooth except possibly at the corner (if there is one) of S' . Since S' is flat, u' is a harmonic function. Note that $u'(\cdot)$ attains its maximum value of 1 at O . By the strong maximum principle for harmonic functions, $u' \equiv 1$ on the connected component of $S' \setminus \partial S'$ containing O . But $u' \equiv 0$ on $\partial S'$, a contradiction. Thus p is in the interior of S , where the smooth convergence $u_n \rightarrow u$ implies that $u(p) = \lim u(p_n) = 1$.

This completes the proof of claim 8.14 (and therefore also the proof of assertion (2) in proposition 8.12.) \square

To prove assertion (3) of proposition 8.12, note that by assertion (1) of the proposition applied to the g_n ,

$$\|g_n\|_0 + \|Dg_n\| \rightarrow 0.$$

Thus if Σ_n is the normal graph of g_n , then $\Sigma_n \subset V(S, \epsilon_n)$ for $\epsilon_n \rightarrow 0$. Hence assertion (3) of the proposition is a special case of assertion (4).

Thus it remain only to prove assertion (4). Suppose it is false. Then (after passing to a subsequence) there exist embedded minimal Y -surfaces $\Sigma_n \neq S_n$ such that $\partial \Sigma_n = \partial S_n$ and such that

$$(*) \quad \Sigma_n \subset \overline{V(S, \epsilon_n)} \text{ with } \epsilon_n \rightarrow 0.$$

Now (*) implies, by the extension of Allard's boundary regularity theorem in [Whi16], that the Σ_n converge smoothly to S away from the corners of S . (We apply theorem 6.1 of [Whi16] in the ambient space obtained by removing the corners of S from $\mathbf{S}^2 \times \mathbf{R}$.)

Choose a point $q_n \in \Sigma_n$ that maximizes $\text{dist}(\cdot, S_n)$. Let p_n be the point in S_n closest to q_n . Since $\partial S_n = \partial \Sigma_n$,

$$(12) \quad \text{dist}(p_n, q_n) \leq \text{dist}(p_n, \partial \Sigma_n) = \text{dist}(p_n, \partial S_n).$$

By passing to a subsequence, we may assume that p_n converges to a limit $p \in \overline{S}$.

If p is not a corner of S , then the smooth convergence $\Sigma_n \rightarrow S$ away from the corners implies that there is a bounded Y -invariant jacobi field u on $S \setminus C$ such that u vanishes on $\partial S \setminus C = \Gamma \setminus C$ and such that

$$\max |u(\cdot)| = u(p) = 1.$$

By standard removal of singularities (see the second paragraph of the proof of claim 8.14), the function u extends continuously to the corners. By hypothesis, there is no such u . Thus p must be one of the corners of S (i.e., one of the corners

⁷See Remark 8.4.

of Γ .) Translate S_n , Σ_n , and q_n by $-p_n$ and dilate by $1/\text{dist}(p_n, \partial S_n)$ to get S'_n , Σ'_n , and q'_n .

By passing to a subsequence, we can assume that the S'_n converge to one of the planar regions S' listed in the statement of lemma 8.13. We can also assume that the Σ'_n converge as sets to a limit set Σ' , and that the points q'_n converge to a limit point q' . Note that

$$(13) \quad \sup_{\Sigma'} \text{dist}(\cdot, S') = \text{dist}(q', S') \leq \text{dist}(O, S') = 1$$

by (12).

We claim that $\Sigma' \subset S'$. We prove this using catenoid barriers as follows. Let P be the plane containing S' and consider a connected component \mathcal{C} of the set of catenoids whose waists are circles in $P \setminus S'$. (There are either one or two such components according to whether $P \setminus S'$ has one or two components.) Note that the ends of each such catenoid are disjoint from Σ' since Σ' lies with a bounded distance of S' . By the strong maximum principle, the catenoids in \mathcal{C} either all intersect S' or else are all disjoint from S' . Now \mathcal{C} contains catenoids whose waists are unit circles that are arbitrarily far from S' . Such a catenoid (if its waist is sufficiently far from S') is disjoint from Σ' . Thus all the catenoids in \mathcal{C} are disjoint from Σ' . We have shown that if the waist of catenoid is a circle in $P \setminus S'$, then the catenoid is disjoint from Σ' . The union of all such catenoids is $\mathbf{R}^3 \setminus S'$, so $\Sigma' \subset S'$ as claimed.

Again by the extension of Allard's boundary regularity theorem in [Whi16, theorem 6.1], the Σ'_n must converge smoothly to S' except at the corner (if there is one) of S' .

The smooth convergence of Σ'_n and S'_n to S' implies existence of a bounded jacobi field u' on S' that is smooth except at the corner, that takes its maximum value of 1 at O , and that vanishes on $\partial S'$. Since S' is flat, u' is a harmonic function. By the maximum principle, $u' \equiv 1$ on the connected component of $S' \setminus \partial S'$ containing O . But that is a contradiction since u' vanishes on $\partial S'$. \square

9. ADDITIONAL PROPERTIES OF THE FAMILY $t \mapsto S(t)$

We now prove that the surfaces $S(t)$ of theorem 8.8 have a strong uniqueness property for small t :

9.1. Theorem. *Let $t \in (0, \tau] \mapsto S(t)$ be the one-parameter family of minimal Y -surfaces given by theorem 8.8. For every sufficiently small $\epsilon > 0$, there is a $\tau' > 0$ with the following property. For every $t \in (0, \tau']$, the surface $S(t)$ lies in $V(S, \epsilon)$ (the small neighborhood of S defined in section 8) and is the unique minimal embedded Y -surface in $V(S, \epsilon)$ with boundary $\Gamma(t)$.*

Proof. Suppose the theorem is false. Then there is a sequence of $\epsilon_n \rightarrow 0$ such that, for each n , either

- (1) there are arbitrarily large t for which $S(t)$ is not contained in $V(S, \epsilon_n)$, or
- (2) there is a t_n for which $S(t_n)$ is contained in $V(S, \epsilon_n)$ but such that $V(S, \epsilon_n)$ contains a second embedded minimal Y -surface Σ_n with boundary $\Gamma(t_n)$.

The first is impossible since $S(t) \rightarrow S$ as $t \rightarrow 0$. Thus the second holds for each n . But (2) contradicts assertion (4) of proposition 8.12. \square

According to theorem 8.8, for each embedded minimal Y -surface S bounded by Γ , we get a family of minimal surfaces $t \mapsto S(t)$ with $\partial S(t) = \Gamma(t)$. The following theorem says, roughly speaking, that as $t \rightarrow 0$, those surfaces account for all minimal embedded Y -surfaces bounded by $\Gamma(t)$.

9.2. Theorem. *Let $t \mapsto \Gamma(t)$ be a rounding of Γ . Let S_n be a sequence of embedded minimal Y -surfaces in $H^+ \cap \{|z| \leq h\}$ such that $\partial S_n = \Gamma(t_n)$ where $t_n \rightarrow 0$. Suppose the number of points in $S_n \cap Y^+$ is bounded independent of n . Then, after passing to a subsequence, the S_n converge to a smooth minimal embedded Y -surface S bounded by Γ , and $S_n = S(t_n)$ for all sufficiently large n , where $t \mapsto S(t)$ is the one-parameter family given by theorem 8.8.*

Proof. The areas of the S_n are uniformly bounded by hypothesis on the Riemannian metric on $\mathbf{S}^2 \times \mathbf{R}$: see (3'') in remark 7.3. Using the Gauss-Bonnet theorem, the minimality of the S_n , and the fact that the sectional curvatures of $\mathbf{S}^2 \times \mathbf{R}$ are bounded, it follows that

$$\int_{S_n} \beta(S_n, \cdot) dA$$

is uniformly bounded, where $\beta(S_n, x)$ is the square of the norm of the second fundamental form of S_n at x . It follows (see [Whi87, theorem 3]) that after passing to a subsequence, the S_n converge smoothly (away from the corners of Γ) to a minimal embedded Y -surface S with boundary Γ . By the uniqueness theorem 9.1, $S_n = S(t_n)$ for all sufficiently large n . \square

10. COUNTING THE NUMBER OF POINTS IN $Y \cap S(t)$

Consider a rounding $t \rightarrow \Gamma(t)$ of a boundary curve Γ , as specified in definition 8.3. There are two qualitatively different ways to do the rounding at the crossings O and O^* . We describe what can happen at O (the same description holds at O^*):

- (1) Near O , each $\Gamma(t)$ connects points of Z^+ to points of X^+ (and therefore points of Z^- to points of X^-), or
- (2) the curve $\Gamma(t)$ connects points of Z^+ to points of X^- (and therefore points of Z^- to points of X^+).

10.1. Definition. In case (1), the rounding $t \rightarrow \Gamma(t)$ is *positive* at O . In case (2), the rounding $t \rightarrow \Gamma(t)$ is *negative* at O . Similar statements hold at O^* .

In what follows, we will use the notation $\|A\|$ to denote the number of elements in a finite set A .

10.2. Proposition. *Let S be an open minimal embedded Y -surface in $N := \overline{H^+} \cap \{|z| \leq h\}$ bounded by Γ . Let $t \mapsto S(t)$ be the family given by theorem 8.8, and suppose $S \cap Y$ has exactly n points. Then*

$$\|S(t) \cap Y\| = \|S \cap Y\| + \delta(S, \Gamma(t))$$

where $\delta(S, \Gamma(t))$ is 0, 1, or 2 according to whether the signs of S and $\Gamma(t)$ agree at both O and O^* , at one but not both of O and O^* , or at neither O nor O^* . (In other words, $\delta(S, \Gamma(t))$ is the number of sign disagreements of S and $\Gamma(t)$. See Figure 5.)

Proof. Recall that $S(t)$ is normal graph over $\Omega(t)$, the region in $M = \overline{S \cup \rho_Z S}$ bounded by the image of $\Gamma(t)$ under the nearest point projection from a neighborhood of M to M . It follow immediately that

$$\|Y \cap S(t)\| = \|Y \cap \Omega(t)\|.$$

Note that $Y \cap \Omega(t)$ consists of $Y \cap S$ together with one or both of the points O and O^* . (The points O and O^* in $\partial S = \Gamma$ do not belong to S because S is open.) Recall also (see remark 8.7) that $O \in \Omega(t)$ if and only if S and $\Gamma(t)$ have the same sign at O . Likewise, $O^* \in \Omega(t)$ if and only if S and $\Gamma(t)$ have the same sign at O^* . The result follows immediately. \square

10.3. Definition. Let $\mathcal{M}(\Gamma)$ be the set of all open, minimal embedded Y -surfaces $S \subset N$ such that $\partial S = \Gamma$. (Here $\Gamma = \Gamma_C$ is the curve in the statement of theorem 7.1.)

Let $\mathcal{M}^s(\Gamma, n)$ be the set of surfaces S in $\mathcal{M}(\Gamma)$ such that $S \cap Y = n$ and such that S has sign s at O .

If Γ' is a smooth, ρ_Y -invariant curve (e.g., one of the rounded curves $\Gamma(t)$) in $\overline{H^+}$ such that Γ'/ρ_Y has exactly one component, we let $\mathcal{M}(\Gamma', n)$ be the set of embedded minimal Y -surfaces S in $\overline{H^+}$ such that $\partial S = \Gamma'$ and such that $S \cap Y$ has exactly n points.

10.4. Proposition. *Suppose the rounding $t \mapsto \Gamma(t)$ is positive at O and at O^* .*

- (1) *If n is even and $S \in \mathcal{M}^+(\Gamma, n)$, then $S(t) \in \mathcal{M}(\Gamma(t), n)$.*
- (2) *If n is odd and $S \in \mathcal{M}^s(\Gamma, n)$, then $S(t) \in \mathcal{M}(\Gamma(t), n+1)$.*
- (3) *If n is even and $S \in \mathcal{M}^-(\Gamma, n)$, then $S(t) \in \mathcal{M}(\Gamma(t), n+2)$.*

10.5. Remark. Of course, the statement remains true if we switch all the signs.

Proof. If n is odd and $S \in \mathcal{M}^s(\Gamma, n)$, then S has different signs at O and O^* by lemma 5.4, and thus $\delta(S, \Gamma(t)) = 1$.

Now suppose that n is even and that $S \in \mathcal{M}^s(\Gamma, n)$. Then by lemma 5.4, the surface S has the same sign at O^* as at O , namely s . Thus $\delta(S, \Gamma)$ is 0 if $s = +$ and is 2 if $s = -$. Proposition 10.4 now follows immediately from proposition 10.2. \square

10.6. Proposition. *Suppose the rounding $t \mapsto \Gamma(t)$ has sign s at O and $-s$ at O^* .*

- (1) *If n is odd and $S \in \mathcal{M}^s(\Gamma, n)$, then $S(t) \in \mathcal{M}(\Gamma(t), n)$.*
- (2) *If n is even and S is in $\mathcal{M}^+(\Gamma, n)$ or $\mathcal{M}^-(\Gamma, n)$, then $S(t) \in \mathcal{M}(\Gamma(t), n+1)$.*
- (3) *If n is odd and $S \in \mathcal{M}^{-s}(\Gamma, n)$, then $S(t) \in \mathcal{M}(\Gamma(t), n+2)$.*

The proof is almost identical to the proof of proposition 10.4.

10.7. Theorem. *For every nonnegative integer n and for each sign s , the set $\mathcal{M}^s(\Gamma, n)$ has an odd number of surfaces.*

10.8. Remark. Note that theorem 10.7 is the same as theorem 7.1, because ever since section 7, we have been working with an arbitrary Riemannian metric on $\mathbf{S}^2 \times \mathbf{R}$ that satisfies the hypotheses of theorem 7.1. By proposition 7.4, theorem 7.1 implies theorem 6.1, which by proposition 6.2 implies theorem 5.1, which by proposition 5.2 implies theorem 2 for $h < \infty$. Thus in proving theorem 10.7, we complete the proof of the periodic case of theorem 2.

Proof. Let $f^s(n)$ denote the mod 2 number of surfaces in $\mathcal{M}^s(\Gamma, n)$. Note that $f^s(n) = 0$ for $n < 0$ since $Y \cap S$ cannot have a negative number of points. The theorem asserts that $f^s(n) = 1$ for every $n \geq 0$.

We prove the theorem by induction. Thus we let n be a nonnegative integer, we assume that $f^s(k) = 1$ for all nonnegative $k < n$ and $s = \pm$, and we must prove that $f^s(n) = 1$.

Case 1: n is even and s is $+$.

To prove that $f^+(n) = 1$, we choose a rounding $t \mapsto \Gamma(t)$ that is positive at both O and O^* .

We choose τ sufficiently small that for every $S \in \mathcal{M}(\Gamma)$ with $\|Y \cap S\| \leq n$, the family $t \mapsto S(t)$ is defined for all $t \in (0, \tau]$. We may also choose τ small enough that if S and S' are two distinct such surfaces, then $S(t) \neq S'(t)$ for $t \leq \tau$. (This is possible since $S(t) \rightarrow S$ and $S'(t) \rightarrow S'$ as $t \rightarrow 0$.)

By theorem 9.2, we can fix a t sufficiently small that for each surface $\Sigma \in \mathcal{M}(\Gamma(t), n)$, there is a surface $S = S_\Sigma \in \mathcal{M}(\Gamma)$ such that $\Sigma = S_\Sigma(t)$. Since all such $S(t)$ are ρ_Y -nondegenerate, this implies

(14) The surfaces in $\mathcal{M}(\Gamma(t), n)$ are all ρ_Y -nondegenerate.

By proposition 10.4, S_Σ belongs to the union U of

(15) $\mathcal{M}^+(\Gamma, n)$, $\mathcal{M}^+(\Gamma, (n-1))$, $\mathcal{M}^-(\Gamma, (n-1))$, and $\mathcal{M}^-(\Gamma, (n-2))$.

By the same proposition, if S belongs to the union U , then $S(t) \in \mathcal{M}(\Gamma(t), n)$. Thus $\Sigma \mapsto S_\Sigma$ gives a bijection from $\mathcal{M}(\Gamma(t), n)$ to U , so the number of surfaces in $\mathcal{M}(\Gamma(t), n)$ is equal to the sum of the numbers of surfaces in the four sets in (15). Reducing mod 2 gives

(16) $\|\mathcal{M}(\Gamma(t), n)\|_{\text{mod } 2} = f^+(n) + f^+(n-1) + f^-(n-1) + f^-(n-2)$.

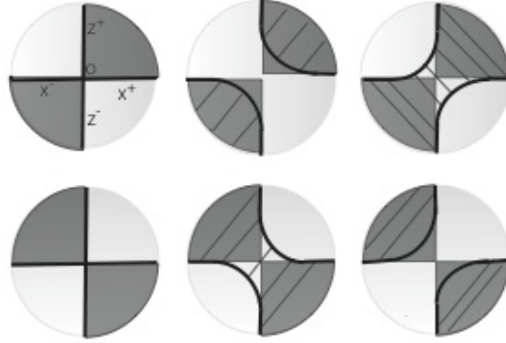

FIGURE 5. The sign of S and $\Gamma(t)$ at O .

The behavior near O of a surface $S \subset H^+$ with boundary Γ .

First Column: The surface S , here illustrated by the darker shading, is tangent at O to either the positive quadrants of H (as illustrated on top) or the negative quadrants (on the bottom). In the sense of section 3, S is positive at O in the top illustration and negative in the bottom illustration.

Second column: A curve $\Gamma(t)$ in a positive rounding $t \rightarrow \Gamma(t)$ of Γ . The striped regions lie in the projections $\Omega(t)$ defined in theorem 8.8. Note that on the top $O \notin \Omega(t)$. On the bottom, $O \in \Omega(t)$.

Third Column: A curve $\Gamma(t)$ in a negative rounding of Γ . The striped regions lie in $\Omega(t)$. Note that on top we have $O \in \Omega(t)$. On the bottom, $O \notin \Omega(t)$.

By induction, $f^+(n-1) = f^-(n-1)$ (it is 0 for $n = 0$ and 1 if $n \geq 2$), so

$$(17) \quad \|\mathcal{M}(\Gamma(t), n)\|_{\text{mod } 2} = f^+(n) + f^-(n-2).$$

As mentioned earlier, we have good knowledge about the mod 2 number of minimal surfaces bounded by suitably bumpy smooth embedded curves. In particular, $\Gamma(t)$ is smooth and embedded and has the bumpiness property (14), which implies that (see theorem 11.2)

$$(18) \quad \|\mathcal{M}(\Gamma(t), n)\|_{\text{mod } 2} = \begin{cases} 1 & \text{if } n = 1 \text{ and } \Gamma(t) \text{ is connected,} \\ 1 & \text{if } n = 0 \text{ and } \Gamma(t) \text{ is not connected, and} \\ 0 & \text{in all other cases.} \end{cases}$$

Combining (17) and (18) gives $f^+(n) = 1$.

Case 2: n is even and s is $-$. The proof is exactly like the proof of case 1, except that we use a rounding that is negative at O and at O^* . (See remark 10.5.)

Cases 3 and 4: n is odd and s is $+$ or $-$.

The proof is almost identical to the proof in the even case, except that we use a rounding $t \mapsto \Gamma(t)$ that has sign s at O and $-s$ at O^* . In this case we still get a bijection $\Sigma \mapsto S_\Sigma$, but it is a bijection from $\mathcal{M}(\Gamma(t), n)$ to the union U of the sets

$$(19) \quad \mathcal{M}^s(\Gamma, n), \mathcal{M}^+(\Gamma, n-1), \mathcal{M}^-(\Gamma, n-1), \text{ and } \mathcal{M}^{-s}(\Gamma, n-2).$$

Thus $\mathcal{M}(\Gamma(t), n)$ and U have the same number of elements mod 2:

$$\|\mathcal{M}(\Gamma(t), n)\|_{\text{mod } 2} = f^s(n) + f^+(n-1) + f^-(n-1) + f^{-s}(n-2).$$

As in case 1, $f^+(n-1) = f^-(n-1)$ by induction, so their sum is 0:

$$\|\mathcal{M}(\Gamma(t), n)\|_{\text{mod } 2} = f^s(n) + f^{-s}(n-2).$$

Combining this with (18) gives $f^s(n) = 1$. □

11. COUNTING MINIMAL SURFACES BOUNDED BY SMOOTH CURVES

In the previous section, we used certain facts about the mod 2 numbers of minimal surfaces bounded by smooth curves. In this section we state those facts, and show that they apply in our situation. The actual result we need is theorem 11.2 below, and the reader may go directly to that result. However, we believe it may be helpful to first state a simpler result that has the main idea of theorem 11.2:

11.1. Theorem. *Suppose N is compact, smooth, strictly mean-convex Riemannian 3-manifold diffeomorphic to the a ball. Suppose also that N contains no smooth, closed minimal surfaces. Let Σ be any compact 2-manifold with boundary. Let Γ be a smooth embedded curve in ∂N , and let $\mathcal{M}(\Gamma, \Sigma)$ be the set of embedded minimal surfaces in N that have boundary Γ and that are diffeomorphic to Σ . Suppose all the surfaces in $\mathcal{M}(\Gamma, \Sigma)$ are nondegenerate. Then the number of those surfaces is odd if Σ is a disk or union of disks, and is even if not.*

See [HW08, theorem 2.1] for the proof.

If we replace the assumption of strict mean convexity by mean convexity, then Γ may bound a minimal surface in ∂N . In that case, theorem 11.1 remains true provided (i) we assume that no two adjacent components of $\partial N \setminus \Gamma$ are both minimal surfaces, and (ii) we count minimal surfaces in ∂N only if they are stable. Theorem 11.1 also generalizes to the case of curves and surfaces invariant under

a finite group G of symmetries of N . If one of those symmetries is 180° rotation about a geodesic Y , then the theorem also generalizes to Y -surfaces:

11.2. Theorem. *Let N be a compact region in a smooth Riemannian 3-manifold such that N is homeomorphic to the 3-ball. Suppose that N has piecewise smooth, weakly mean-convex boundary, and that N contains no closed minimal surfaces. Suppose also that N admits a 180° rotational symmetry ρ_Y about a geodesic Y .*

Let C be a ρ_Y -invariant smooth closed curve in $(\partial N) \setminus Y$ such that C/ρ_Y is connected, and such that no two adjacent components of $(\partial N) \setminus C$ are both smooth minimal surfaces. Let $\mathcal{M}^(C, n)$ be the collection of G -invariant, minimal embedded Y -surfaces S in N with boundary C such that (i) $S \cap Y$ has exactly n points, and (ii) if $S \subset \partial N$, then S is stable. Suppose C is (Y, n) -bumpy in the following sense: all the Y -surfaces in $\mathcal{M}^*(C, n)$ are ρ_Y -nondegenerate (i.e., have no nontrivial ρ_Y -invariant jacobian fields.) Then:*

- (1) *If C has two components and $n = 0$, the number of surfaces in $\mathcal{M}^*(C, n)$ is odd.*
- (2) *If C has one component and $n = 1$, the number of surfaces in $\mathcal{M}^*(C, n)$ is odd.*
- (3) *In all other cases, the number of surfaces in $\mathcal{M}^*(C, n)$ is even.*

We remark (see corollary 4.3) that in case (2), each surface in $\mathcal{M}^*(C, n)$ is a disk, in case (1), each surface in $\mathcal{M}^*(C, n)$ is the union of two disks, and in case (3), each surface in $\mathcal{M}^*(C, n)$ has more complicated topology (it is connected but not simply connected).

Theorem 11.2 is proved in [HW08, §4.7].

In the proof of theorem 10.7, we invoked the conclusion of theorem 11.2. We now justify that. Let $\Gamma(t)$ be the one of the curves formed by rounding Γ in section 8.2. Note that $\Gamma(t)$ bounds a unique minimal surface $\Omega(t)$ that lies in the helicoidal portion of ∂N , i.e, that lies in $H \cap \{|z| \leq h\}$. (The surface $\Omega(t)$ is topologically a disk, an annulus, or a pair of disks, depending on the signs of the rounding at O and O^* .) Note also that the complementary region $(\partial N) \setminus \Omega(t)$ is piecewise smooth, but not smooth. To apply theorem 11.2 as we did, we must check that:

- (i) N contains no closed minimal surfaces.
- (ii) No two adjacent components of ∂N are smooth minimal surfaces.
- (iii) The surface $\Omega(t)$ is strictly stable. (We need this because in the proof of theorem 10.7, we counted $\Omega(t)$, whereas theorem 11.2 tells us to count it only if it is stable.)

Now (i) is true by hypothesis on the Riemannian metric on N : see theorem 7.1(3). Also, (ii) is true because (as mentioned above) the surface $(\partial N) \setminus \Omega(t)$ is piecewise-smooth but not smooth.

On the other hand, (iii) need not be true in general. However, in the proof of theorem 10.7, we were allowed to choose $t > 0$ as small as we like, and (iii) is true if t is sufficiently small:

11.3. Lemma. *Let $t \mapsto \Gamma(t) \subset H$ be a rounding as in theorem 8.8. Then the region $\Omega(t)$ in ∂N bounded by $\Gamma(t)$ is strictly stable provided t is sufficiently small.*

(We remark that is a special case of a more general principle: if two strictly stable minimal surfaces are connected by suitable thin necks, the resulting surface is also strictly stable.)

Proof. Let $\lambda(t)$ be the lowest eigenvalue of the jacobi operator on $\Omega(t)$. Note that $\lambda(t)$ is bounded. (It is bounded below by the lowest eigenvalue of a domain in H that contains all the $\Omega(t)$ and above by the lowest eigenvalue of a domain that is contained in all the $\Omega(t)$.) It follows that any subsequential limit λ as $t \rightarrow 0$ of the $\lambda(t)$ is an eigenvalue of the jacobi operator on Ω , where Ω is the region in H bounded by Γ . (This is a special case of claim 8.14.)

By hypothesis⁸ (2) of theorem 7.1, Ω is strictly stable, so $\lambda > 0$ and therefore $\lambda(t) > 0$ for all sufficiently small $t > 0$. \square

12. GENERAL RESULTS ON EXISTENCE OF LIMITS

At this point, we have completed the proof of theorem 2 in the case $h < \infty$. That is, we have established the existence of periodic genus- g helicoids in $\mathbf{S}^2(R) \times \mathbf{R}$. During that proof (in sections 7–11), we considered rather general Riemannian metrics on $\mathbf{S}^2(R) \times \mathbf{R}$. However, from now on we will always use the standard product metric. In the remainder of part I of the paper,

- (1) We prove existence of nonperiodic genus- g helicoids in $\mathbf{S}^2(R) \times \mathbf{R}$ by taking limits of periodic examples as the period tends to ∞ .
- (2) We prove existence of helicoid-like surfaces in \mathbf{R}^3 by taking suitable limits of nonperiodic examples in $\mathbf{S}^2(R) \times \mathbf{R}$ as $R \rightarrow \infty$.

(We remark that one can also get periodic genus g -helicoids in \mathbf{R}^3 as limits of periodic examples in $\mathbf{S}^2(R) \times \mathbf{R}$ as $R \rightarrow \infty$ with the period kept fixed.)

Of course one could take the limit as sets in the Gromov-Hausdorff sense. But to get smooth limits, one needs curvature estimates and local area bounds: without curvature estimates, the limit need not be smooth, whereas with curvature estimates but without local area bounds, limits might be minimal laminations rather than smooth, properly embedded surfaces.

In fact, local area bounds are the key, because such bounds allow one to use the following compactness theorem (which extends similar results in [CS85], [And85], and [Whi87]):

12.1. Theorem (General Compactness Theorem). *Let Ω be an open subset of a Riemannian 3-manifold. Let g_n be a sequence of smooth Riemannian metrics on Ω converging smoothly to a Riemannian metric g . Let $M_n \subset \Omega$ be a sequence of properly embedded surfaces such that M_n is minimal with respect to g_n . Suppose also that the area and the genus of M_n are bounded independently of n . Then (after passing to a subsequence) the M_n converge to a smooth, properly embedded g -minimal surface M' . For each connected component Σ of M' , either*

- (1) *the convergence to Σ is smooth with multiplicity one, or*
- (2) *the convergence is smooth (with some multiplicity > 1) away from a discrete set S .*

In the second case, if Σ is two-sided, then it must be stable.

Now suppose Ω is an open subset of \mathbf{R}^3 . (The metric g need not be flat.) If $p_n \in M_n$ converges to $p \in M$, then (after passing to a further subsequence) either

$$\text{Tan}(M_n, p_n) \rightarrow \text{Tan}(M, p)$$

⁸This is the only place where that hypothesis is used.

or there exists constants $c_n > 0$ tending to 0 such that the surfaces

$$\frac{M_n - p_n}{c_n}$$

converge to a non flat complete embedded minimal surface $M' \subset \mathbf{R}^3$ of finite total curvature with ends parallel to $\text{Tan}(M, p)$.

See [Whi17a] for the proof.

When we apply theorem 12.1, in order to get smooth convergence everywhere (and not just away from a discrete set), we will prove that the limit surface has no stable components. For that, we will use the following theorem of Fischer-Colbrie and Schoen. (See theorem 3 on page 206 and paragraph 1 on page 210 of [FCS80].)

Theorem. *Let M be an orientable, complete, stable minimal surface in a complete, orientable Riemannian 3-manifold of nonnegative Ricci curvature. Then M is totally geodesic, and its normal bundle is Ricci flat. (In other words, if ν is a normal vector to M , then $\text{Ricci}(\nu, \nu) = 0$.)*

12.2. Corollary. *If M is a connected, stable, properly embedded, minimal surface in $\mathbf{S}^2 \times \mathbf{R}$, then M is a horizontal sphere.*

To prove the corollary, note that since $\mathbf{S}^2 \times \mathbf{R}$ is orientable and simply connected and since M is properly embedded, M is orientable. Note also that if $\text{Ricci}(\nu, \nu) = 0$, then ν is a vertical vector.

In section 13, we prove the area bounds we need to get nonperiodic examples in $\mathbf{S}^2 \times \mathbf{R}$. In section 14, we prove area and curvature bounds in $\mathbf{S}^2(R) \times \mathbf{R}$ as $R \rightarrow \infty$. In section 15, we get examples in \mathbf{R}^3 by letting $R \rightarrow \infty$.

13. UNIFORM LOCAL AREA BOUNDS IN $\mathbf{S}^2 \times \mathbf{R}$

Let $\theta : \overline{H^+} \setminus (Z \cup Z^*) \rightarrow \mathbf{R}$ be the natural angle function which, if we identify $\mathbf{S}^2 \setminus \{O^*\}$ with \mathbf{R}^2 by stereographic projection, is given by $\theta(x, y, z) = \arg(x + iy)$. Note that since $\overline{H^+}$ is simply connected, we can let θ take values in \mathbf{R} rather than in \mathbf{R} modulo 2π .

13.1. Proposition. *Suppose H is a helicoid in $\mathbf{S}^2 \times \mathbf{R}$ with axes Z and Z^* . Let M be a minimal surface in $\overline{H^+}$ with compact, piecewise-smooth boundary, and let*

$$S = M \cap \{a \leq z \leq b\} \cap \{\alpha \leq \theta \leq \beta\}.$$

Then

$$\text{area}(S) \leq (b - a) \int_{(\partial M) \cap \{z > a\}} |\mathbf{v}_z \cdot \nu_{\partial M}| ds + (\beta - \alpha) \int_{(\partial M) \cap \{\theta > \alpha\}} |\mathbf{v}_\theta \cdot \nu_{\partial M}| ds$$

where $\mathbf{v}_z = \frac{\partial}{\partial z}$, $\mathbf{v}_\theta = \frac{\partial}{\partial \theta}$, and where $\nu_{\partial M}$ is the unit normal to ∂M that points out of M .

Proof. Let $u : \mathbf{S}^2 \times \mathbf{R}$ be the function $z(\cdot)$ or the function $\theta(\cdot)$. In the second case, u is well-defined as a single-valued function only on H^+ . But in both cases, $\mathbf{v} = \mathbf{v}_u := \frac{\partial}{\partial u}$ is well-defined Killing field on all of $\mathbf{S}^2 \times \mathbf{R}$. (Note that $\mathbf{v}_\theta \equiv 0$ on $Z \cup Z^*$.)

Now consider the vectorfield $w(u)\mathbf{v}$, where $w : \mathbf{R} \rightarrow \mathbf{R}$ is given by

$$w(u) = \begin{cases} 0 & \text{if } u < a, \\ u - a & \text{if } a \leq u \leq b, \text{ and} \\ b - a & \text{if } b < u. \end{cases}$$

Then⁹

$$\begin{aligned} \int_M \operatorname{div}_M(w\mathbf{v}) dA &= \int_M (\nabla_M(w(u)) \cdot \mathbf{v} + w(u) \operatorname{div}_M \mathbf{v}) dA \\ &= \int_M (w'(u) \nabla_M u \cdot \mathbf{v} + 0) dA \\ &= \int_{M \cap (u^{-1}[a,b])} \nabla_M u \cdot \mathbf{v} dA \end{aligned}$$

since $\operatorname{div}_M \mathbf{v} \equiv 0$ (because \mathbf{v} is a Killing vectorfield.)

Let $\mathbf{e} = \mathbf{e}_u$ be a unit vectorfield in the direction of ∇u . Then $\nabla u = |\nabla u| \mathbf{e}$ and $\mathbf{v} = \frac{\partial}{\partial u} = |\nabla u|^{-1} \mathbf{e}$, so

$$\begin{aligned} \nabla_M u \cdot \mathbf{v} &= (\nabla u)_M \cdot (\mathbf{v})_M \\ &= (|\nabla u| \mathbf{e})_M \cdot (|\nabla u|^{-1} \mathbf{e})_M \\ &= |(\mathbf{e})_M|^2 \\ &= 1 - (\mathbf{e} \cdot \nu_M)^2 \end{aligned}$$

where $(\cdot)_M$ denotes the component tangent to M and where ν_M is the unit normal to M .

Hence we have shown

$$(20) \quad \int_M \operatorname{div}_M(w\mathbf{v}) dA = \int_{M \cap \{a \leq u \leq b\}} (1 - (\mathbf{e}_u \cdot \nu_M)^2) dA.$$

Since M is a minimal surface,

$$\operatorname{div}_M(V) = \operatorname{div}_M(V^{\tan})$$

for any vectorfield V (where V^{\tan} is the component of V tangent to M), so

$$\begin{aligned} (21) \quad \int_M \operatorname{div}_M(w\mathbf{v}) dA &= \int_M \operatorname{div}_M(w\mathbf{v})^{\tan} dA \\ &= \int_{\partial M} (w\mathbf{v}) \cdot \nu_{\partial M} \\ &\leq (b-a) \int_{(\partial M) \cap \{u > a\}} |\mathbf{v}_u \cdot \nu_{\partial M}| \end{aligned}$$

Combining (20) and (21) gives

$$\int_{M \cap \{a \leq u \leq b\}} (1 - (\mathbf{e}_u \cdot \nu_M)^2) dA \leq (b-a) \int_{(\partial M) \cap \{u > a\}} |\mathbf{v}_u \cdot \nu_{\partial M}|$$

⁹The reader may find it helpful to note that in the proof, we are expressing $\frac{d}{dt} \operatorname{area}(M_t)$ in two different ways (as a surface integral and as a boundary integral), where M_t is a one-parameter family of surfaces with $M_0 = M$ and with initial velocity vectorfield $w(u)\mathbf{v}$.

Adding this inequality for $u = z$ to the same inequality for $u = \theta$ (but with α and β in place of a and b) gives

$$(22) \quad \begin{aligned} & \int_S (2 - (\mathbf{e}_z \cdot \nu_M)^2 - (\mathbf{e}_\theta \cdot \nu_M)^2) dA \\ & \leq (b - a) \int_{(\partial M) \cap \{z > a\}} |\mathbf{v}_z \cdot \nu_{\partial M}| ds \\ & \quad + (\beta - \alpha) \int_{(\partial M) \cap \{\theta > \alpha\}} |\mathbf{v}_\theta \cdot \nu_{\partial M}| ds \end{aligned}$$

Let \mathbf{e}_ρ be a unit vector orthogonal to \mathbf{e}_z and \mathbf{e}_θ . Then for any unit vector ν ,

$$1 = (\mathbf{e}_z \cdot \nu)^2 + (\mathbf{e}_\theta \cdot \nu)^2 + (\mathbf{e}_\rho \cdot \nu)^2,$$

so the integrand in the left side of (22) is $\geq 1 + (\mathbf{e}_\rho \cdot \nu_M)^2 \geq 1$. \square

13.2. Corollary. *Let M be a compact minimal surface in $\overline{H^+}$ and let L be the length of $(\partial M) \setminus (Z \cup Z^*)$. Then*

$$\text{area}(M \cap K) \leq c_H L \text{diam}(K)$$

for every compact set K , where $\text{diam}(K)$ is the diameter of K and where c_H is a constant depending on the helicoid H .

The corollary follows immediately from proposition 13.1 because $\mathbf{v}_z \cdot \nu_M = 0$ and $\mathbf{v}_\theta = 0$ on $(\partial M) \cap (Z \cup Z^*)$.

14. NONPERIODIC GENUS- g HELICOIDS IN $\mathbf{S}^2 \times \mathbf{R}$: THEOREM 2 FOR $h = \infty$

Fix a helicoid H in $\mathbf{S}^2 \times \mathbf{R}$ with axes Z and Z^* and fix a genus g . For each $h \in (0, \infty]$, consider the class $\mathcal{C}(h) = \mathcal{C}_g(h)$ of embedded, genus- g minimal surfaces M in $\mathbf{S}^2 \times [-h, h]$ such that

- (1) If $h < \infty$, then M is bounded by two great circles at heights h and $-h$. If $h = \infty$, then M is properly embedded with no boundary.
- (2) $M \cap H \cap \{|z| < h\} = (X \cup Z \cup Z^*) \cap \{|z| < h\}$.
- (3) M is a Y -surface.

By the $h < \infty$ case of theorem 2 (see section 5), the collection $\mathcal{C}(h)$ is nonempty for every $h < \infty$. Here we prove the same is true for $h = \infty$:

14.1. Theorem. *Let h_n be a sequence of positive numbers tending to infinity. Let $M_n \in \mathcal{C}(h_n)$. Then a subsequence of the M_n converges smoothly and with multiplicity one to a minimal surface $M \in \mathcal{C}(\infty)$. The surface M has bounded curvature, and each of its two ends is asymptotic to a helicoid having the same pitch as H .*

Proof of theorem 14.1. Note that $M_n \cap H^+$ is bounded by two vertical line segments, by the horizontal great circle X , and by a pair of great semicircles at heights h_n and $-h_n$. It follows that vertical flux is uniformly bounded. Thus by corollary 13.2, for any ball B , the area of

$$M_n \cap H^+ \cap B$$

is bounded by a constant depending only on the radius of the ball. Therefore the areas of the M_n (which are obtained from the $M_n \cap H^+$ by Schwarz reflection) are also uniformly bounded on compact sets. By the compactness theorem 12.1, we can (by passing to a subsequence) assume that the M_n converge as sets to a smooth, properly embedded limit minimal surface M . According to [Ros02, theorem 4.3],

every properly embedded minimal surface in $\mathbf{S}^2 \times \mathbf{R}$ is connected unless it is a union of horizontal spheres. Since M contains $Z \cup Z^*$, it is not a union of horizontal spheres, and thus it is connected. By corollary 12.2, M is unstable. Hence by the general compactness theorem 12.1, the convergence $M_n \rightarrow M$ is smooth with multiplicity one.

Now suppose that each M_n is a Y -surface, i.e., that

- (1) ρ_Y is an orientation-preserving involution of M_n ,
- (2) M_n/ρ_Y is connected, and
- (3) Each 1-cycle Γ in M_n is homologous (in M_n) to $-\rho_Y\Gamma$.

The smooth convergence implies that ρ_Y is also an orientation-preserving involution of M . Since M is connected, so is M/ρ_Y . Also, if Γ is a cycle in M , then the smooth, multiplicity one convergence implies that Γ is a limit of cycles Γ_n in M_n . Thus Γ_n together with $\rho_Y\Gamma_n$ bound a region, call it A_n , in M_n . Note that the $\Gamma_n \cup \rho_Y\Gamma_n$ lie in a bounded region in $\mathbf{S}^2 \times \mathbf{R}$. Therefore so do the A_n (by, for example, the maximum principle applied to the minimal surfaces A_n .) Thus the A_n converge to a region A in M with boundary $\Gamma + \rho_Y\Gamma$. This completes the proof that M is a Y -surface.

Recall that Y intersects any Y -surface transversely, and the number of intersection points is equal to twice the genus plus two. It follows immediately from the smooth convergence (and the compactness of Y) that M has genus g .

The fact that $M \cap H = X \cup Z \cup Z^*$ follows immediately from smooth convergence together with the corresponding property of the M_n .

Next we show that M has bounded curvature. Let $p_k \in M$ be a sequence of points such that the curvature of M at p_k tends to the supremum. Let f_k be a screw motion such that $f_k(H) = H$ and such that $z(f(p_k)) = 0$. The surfaces $f_k(M)$ have areas that are uniformly bounded on compact sets. (They inherit those bounds from the surfaces M_n .) Thus exactly as above, by passing to a subsequence, we get smooth convergence to a limit surface. It follows immediately that M has bounded curvature.

Since M is a minimal embedded surface of finite topology containing $Z \cup Z^*$, each of its two ends is asymptotic to a helicoid by [HW11]. Since $M \cap H = Z \cup Z^*$, those limiting helicoids must have the same pitch as H . (If this is not clear, observe that the intersection of two helicoids with the same axes but different pitch contains an infinite collection of equally spaced great circles.) \square

14.1. Proof of theorem 2 for $h = \infty$. The non-periodic case of theorem 2 follows immediately from the periodic case together with theorem 14.1. The various asserted properties of the non-periodic examples follow from the corresponding properties of the periodic examples together with the smooth convergence in theorem 14.1, except for the noncongruence properties, which are proved in section 18. \square

15. CONVERGENCE TO HELICOIDAL SURFACES IN \mathbf{R}^3

In the section, we study the behavior of genus- g helicoidal surfaces in $\mathbf{S}^2(R) \times \mathbf{R}$ as $R \rightarrow \infty$. The results in this section will be used in section 16 to prove theorem 3 of section 2.

We will identify $\mathbf{S}^2(R)$ with $\mathbf{R}^2 \cup \{\infty\}$ by stereographic projection, and therefore $\mathbf{S}^2(R) \times \mathbf{R}$ with

$$(\mathbf{R}^2 \cup \{\infty\}) \times \mathbf{R} = \mathbf{R}^3 \cup (\{\infty\} \times \mathbf{R}) = \mathbf{R}^3 \cup Z^*.$$

Thus we are working with \mathbf{R}^3 together with a vertical axis Z^* at infinity. The Riemannian metric is

$$(23) \quad \left(\frac{4R^2}{4R^2 + x^2 + y^2} \right)^2 (dx^2 + dy^2) + dz^2.$$

In particular, the metric coincides with the Euclidean metric along the Z axis. Inversion in the cylinder

$$(24) \quad C_{2R} = \{(x, y, z) : x^2 + y^2 = (2R)^2\}$$

is an isometry of (23). Indeed, C_{2R} corresponds to $E \times \mathbf{R}$, where E is the equator of $\mathbf{S}^2 \times \{0\}$ with respect to the antipodal points O and O^* . We also note for further use that

$$(25) \quad \text{dist}_R(C_{2R}, Z) = \pi R/2,$$

where $\text{dist}_R(\cdot, \cdot)$ is the distance function associated to the metric (23).

We fix a genus g and choose a helicoid $H \subset \mathbf{R}^3$ with axis Z and containing X . (Note that it is a helicoid for all choices of R .) As usual, let H^+ be the component of $\mathbf{R}^3 \setminus H$ containing Y^+ , the positive part of the y -axis. Let M be one of the nonperiodic, genus- g examples described in theorem 2. Let

$$S = \text{interior}(M \cap H^+).$$

According to theorem 2, M and S have the following properties:

- (1) S is a smooth, embedded Y -surface in H^+ that intersects Y^+ in exactly g points,
- (2) The boundary¹⁰ of S is $X \cup Z$.
- (3) $M = \bar{S} \cup \rho_Z \bar{S} \cup Z^*$ is a smooth surface that is minimal with respect to the metric (23).

15.1. Definition. An *example* is a triple (S, η, R) with $\eta > 0$ and $0 < R < \infty$ such that S satisfies (1), (2), and (3), where H is the helicoid in \mathbf{R}^3 that has axis Z , that contains X , and that has vertical distance between successive sheets equal to η . In the terminology of the previous sections, H is the helicoid of pitch 2η .

15.2. Convergence Away from the Axes. Until section 15.16 it will be convenient to work not in \mathbf{R}^3 but rather in the universal cover of $\mathbf{R}^3 \setminus Z$, still with the Riemannian metric (23). Thus the angle function $\theta(\cdot)$ will be well-defined and single valued. However, we normalize the angle function so that $\theta(\cdot) = 0$ on Y^+ . (In the usual convention for cylindrical coordinates, $\theta(\cdot)$ would be $\pi/2$ on Y^+ .) Thus $\theta = -\pi/2$ on X^+ and $\theta = \pi/2$ on X^- .

Of course Z and Z^* are not in the universal cover, but $\text{dist}(\cdot, Z)$ and $\text{dist}(\cdot, Z^*)$ still make sense.

Since we are working in the universal cover, each vertical line intersects H^+ in a single segment of length η .

¹⁰Here we are regarding M and S as subsets of \mathbf{R}^3 with the metric (23), so ∂S is $X \cup Z$ and not $X \cup Z \cup Z^*$.

15.3. Theorem (First Compactness Theorem). *Consider a sequence (S_n, η_n, R_n) of examples with R_n bounded away from 0 and with $\eta_n \rightarrow 0$. Suppose that*

(*) *each S_n is graphical in some nonempty, open cylindrical region $U \times \mathbf{R}$ such that $\theta(\cdot) > \pi/2$ on $U \times \mathbf{R}$. In other words, every vertical line in $U \times \mathbf{R}$ intersects M_n exactly once.*

Then after passing to a subsequence, the S_n converge smoothly away from a discrete set K to the surface $z = 0$. The convergence is with multiplicity one where $|\theta(\cdot)| > \pi/2$ and with multiplicity two where $|\theta(\cdot)| < \pi/2$.

Furthermore, the singular set K lies in the region $|\theta(\cdot)| \leq \pi/2$.

15.4. Remark. Later (corollary 15.7 and corollary 15.10) we will show the hypothesis (*) is not needed and that the singular set K lies in Y^+ .

Proof. By passing to a subsequence and scaling, we can assume that the R_n converge to a limit $R \in [1, \infty]$. Note that the H_n^+ converge as sets to the surface $\{z = 0\}$ in the universal cover of $\mathbf{R}^3 \setminus Z$. Thus, after passing to a subsequence, the S_n converge as sets to a closed subset of the surface $\{z = 0\}$. By standard estimates for minimal graphs, the convergence is smooth (and multiplicity one) in $U \times \mathbf{R}$. Thus the area-blowup set

$$Q := \{q : \limsup_n \text{area}(S_n \cap \mathbf{B}(q, r)) = \infty \text{ for all } r > 0\}$$

is contained in $\{z = 0\} \setminus U$ and is therefore a proper subset of $\{z = 0\}$. The constancy theorem for area-blowup sets [Whi16, theorem 4.1] states that the area-blowup set of a sequence of minimal surfaces cannot be a nonempty proper subset of a smooth, connected two-manifold, provided the lengths of the boundaries are uniformly bounded on compact sets. Hence Q is empty. That is, the areas of the S_n are uniformly bounded on compact sets.

Thus by the general compactness theorem 12.1, after passing to a subsequence, the S_n converge smoothly away from a discrete set K to a limit surface S' lying in $\{z = 0\}$. The surface S' has some constant multiplicity in the region where $\theta(\cdot) > \pi/2$. Since the $S_n \cap (U \times \mathbf{R})$ are graphs, that multiplicity must be 1. By ρ_Y symmetry, the multiplicity is also 1 where $\theta < -\pi/2$. Since each S_n has boundary X , the multiplicity of S' where $|\theta(\cdot)| < \pi/2$ must be 0 or 2.

Note that $\tilde{S}_n := S_n \cap \{|\theta(\cdot)| < \pi/2\}$ is nonempty and lies in the solid cylindrical region

$$(26) \quad \{|\theta(\cdot)| \leq \pi/2\} \cap \{|z| \leq 2\eta_n\}$$

and that $\partial\tilde{S}_n$ lies on the cylindrical, vertical edge of that region. It follows (by theorem 17.1 in section 17) that for η_n/R_n sufficiently small, every vertical line that intersects the region (26) is at distance at most $4\eta_n$ from S_n . Thus the limit of the \tilde{S}_n as sets is all of $\{z = 0\} \cap \{|\theta(\cdot)| \leq \pi/2\}$, and so the multiplicity there is two, not zero.

Since the convergence $S_n \rightarrow S'$ is smooth wherever S' has multiplicity 1 (either by the General Compactness Theorem 12.1 or by the Allard Regularity Theorem [All72]), $|\theta(\cdot)|$ must be $\leq \pi/2$ at each point of K . \square

15.5. Theorem. *Let (S_n, η_n, R_n) be a sequence of examples with $R_n \geq 1$ and with $\eta_n \rightarrow 0$. Let f_n be the screw motion through angle α_n that maps H_n^+ to itself, and assume that $|\alpha_n| \rightarrow \infty$. Let $S'_n = f_n(S_n)$. Suppose each S'_n is graphical in some*

nonempty open cylinder $U \times \mathbf{R}$ (as in (*) in Theorem 15.3). Then the S'_n converge smoothly (on compact sets) with multiplicity one to the surface $\{z = 0\}$.

The proof is almost identical to the proof of theorem 15.3, so we omit it.

15.6. Theorem. *For every genus g and angle $\alpha > \pi/2$, there is a $\lambda < \infty$ with the following property. If (S, η, R) is a genus- g example (in the sense of definition 15.1) with*

$$\text{dist}(Z, Z^*) = \pi R > 4\lambda\eta,$$

then S is graphical in the region

$$Q(\lambda\eta, \alpha) := \{|\theta(\cdot)| \geq \alpha, \text{dist}(\cdot, Z \cup Z^*) \geq \lambda\eta\}.$$

Proof. Suppose the result is false for some $\alpha > \pi/2$, and let $\lambda_n \rightarrow \infty$. Then for each n , there is an example (S_n, η_n, r_n) such that

$$(27) \quad \text{dist}_n(Z, Z^*) > 4\lambda_n\eta_n$$

and such that S_n is not a graphical in $Q(\lambda_n\eta_n, \alpha)$. Here $\text{dist}_n(\cdot, \cdot)$ denotes distance with respect the metric that comes from $\mathbf{S}^2(R_n) \times \mathbf{R}$. However, henceforth we will write $\text{dist}(\cdot, \cdot)$ instead of $\text{dist}_n(\cdot, \cdot)$ to reduce notational clutter.

Since the ends of $M_n = \overline{S_n \cup \rho_Z S_n}$ are asymptotic to helicoids as $z \rightarrow \pm\infty$, note that S_n is graphical in $Q(\lambda_n\eta_n, \beta)$ for all sufficiently large β . Let $\alpha_n \geq \alpha$ be the largest angle such that S_n is not graphical in $Q(\lambda_n\eta_n, \alpha_n)$. Note that there must be a point $p_n \in S_n$ such that

$$(28) \quad \theta(p_n) = \alpha_n,$$

$$(29) \quad \text{dist}(p_n, Z \cup Z^*) > \lambda_n\eta_n,$$

and such that $\text{Tan}(S_n, p_n)$ is vertical. Without loss of generality, we may assume (by scaling) that $\text{dist}(p_n, Z \cup Z^*) = 1$. In fact, by symmetry of Z and Z^* , we may assume that

$$1 = \text{dist}(p_n, Z) \leq \text{dist}(p_n, Z^*),$$

which of course implies that $\pi R_n = \text{dist}(Z, Z^*) \geq 2$, and therefore that

$$\lambda_n\eta_n \leq \frac{1}{2}.$$

By passing to a further subsequence, we can assume that

$$\lambda_n\eta_n \rightarrow \mu \in [0, \frac{1}{2}].$$

Since $\lambda_n \rightarrow \infty$, this forces

$$\eta_n \rightarrow 0.$$

We can also assume that

$$\alpha_n \rightarrow \tilde{\alpha} \in [\alpha, \infty].$$

Case 1: $\tilde{\alpha} < \infty$. Then the p_n converge to a point p with $\theta(p) = \tilde{\alpha}$ and with $\text{dist}(p, Z) = \text{dist}(p, Z \cup Z^*) = 1$.

Note that M_n is graphical in the region $Q(\lambda_n\eta_n, \alpha_n)$, and that those regions converge to $Q(\mu, \alpha)$. Thus by the Compactness Theorem 15.3, the S_n converge smoothly and with multiplicity one to $\{z = 0\}$ in the region $|\theta(\cdot)| > \pi/2$. But this is a contradiction since $p_n \rightarrow p$, which is in that region, and since $\text{Tan}(S_n, p_n)$ is vertical.

Case 2: Exactly as in case 1, except that we apply a screw motion f_n to M_n such that $\theta(f_n(p_n)) = 0$. (We then use theorem 15.5 rather than theorem 15.3.) \square

15.7. **Corollary.** *The hypothesis (*) in theorems 15.3 and 15.5 is always satisfied provided n is sufficiently large.*

15.8. **Catenoidal Necks.** The next theorem shows that, in the compactness theorem 15.3, any point away from $Z \cup Z^*$ where the convergence is not smooth must lie on Y , and that near such a point, the S_n have small catenoidal necks.

15.9. **Theorem.** *Let (S_n, η_n, R_n) be a sequence of examples and $p_n \in S_n$ be a sequence of points such that*

$$(30) \quad \text{slope}(S_n, p_n) \geq \delta > 0,$$

(where $\text{slope}(S_n, p_n)$ is the slope of the tangent plane to S_n at p_n) and such that

$$(31) \quad \frac{\text{dist}(p_n, Z \cup Z^*)}{\eta_n} \rightarrow \infty.$$

Then there exist positive numbers c_n such that (after passing to a subsequence) the surfaces

$$(32) \quad \frac{S_n - p_n}{c_n}$$

converge to a catenoid in \mathbf{R}^3 . The waist of the catenoid is a horizontal circle, and the line $(Y^+ - p_n)/c_n$ converges to a line that intersects the waist in two diametrically opposite points.

Furthermore,

$$(33) \quad \frac{\eta_n}{c_n} \rightarrow \infty.$$

and

$$(34) \quad \frac{\text{dist}(p_n, S_n \cap Y^+)}{\eta_n} \rightarrow 0.$$

Proof. By scaling and passing to a subsequence, we may assume that

$$(35) \quad 1 = \text{dist}(p_n, Z) \leq \text{dist}(p_n, Z^*).$$

and that $\theta(p_n)$ converges to a limit $\alpha \in [-\infty, \infty]$. By (31) (a statement that is scale invariant) and by (35), $\eta_n \rightarrow 0$. Thus by theorem 15.6 (and standard estimates for minimal graphs), $|\alpha| \leq \pi/2$.

First we prove that there exist $c_n \rightarrow 0$ such that the surfaces $(S_n - p_n)/c_n$ converge subsequentially to a catenoid with horizontal ends.

Case 1: $|\alpha| = \pi/2$. By symmetry, it suffices to consider the case $\alpha = \pi/2$. Let \tilde{S}_n be obtained from S_n by Schwartz reflection about X^- .

By the last sentence of the general compactness theorem 12.1, there exist numbers $c_n \rightarrow 0$ such that (after passing to a subsequence) the surfaces

$$\frac{\tilde{S}_n - p_n}{c_n}$$

converge smoothly to a complete, non-flat, properly embedded minimal surface $\tilde{S} \subset \mathbf{R}^3$ of finite total curvature whose ends are horizontal. By proposition 4.5, \tilde{S} has genus 0. By a theorem of Lopez and Ros[LR91], the only nonflat, properly

embedded minimal surfaces in \mathbf{R}^3 with genus zero and finite total curvature are the catenoids. Thus \tilde{S} is a catenoid. Note that

$$\frac{S_n - p_n}{c_n}$$

converges to a portion S of \tilde{S} . Furthermore, S is either all of \tilde{S} , or it is a portion of \tilde{S} bounded by a horizontal line $\tilde{X} = \lim_n((X^- - p_n)/c_n)$ in \tilde{S} . Since catenoids contain no lines, in fact $S = \tilde{S}$ is a catenoid.

Case 2: $|\alpha| < \pi/2$. By the last statement of the general compactness theorem 12.1, there are $c_n > 0$ tending to 0 such that (after passing to a subsequence) the surfaces

$$\frac{S_n - p_n}{c_n}$$

converge smoothly to a complete, nonflat, embedded minimal surface $S \subset \mathbf{R}^3$ of finite total curvature with ends parallel to horizontal planes. By monotonicity,

$$(36) \quad \limsup_n \frac{\text{area}\left(\frac{S_n - p_n}{c_n} \cap \mathbf{B}(0, \rho)\right)}{\pi\rho^2} \leq 2$$

for all $\rho > 0$. Thus S' has density at infinity ≤ 2 , so it has at most two ends. If it had just one end, it would be a plane. But it is not flat, so that is impossible. Hence it has two ends. By a theorem of Schoen [Sch83], a properly embedded minimal surface in \mathbf{R}^3 of with finite total curvature and two ends must be a catenoid.

This completes the proof that (after passing to a subsequence) the surfaces $(S_n - p_n)/c_n$ converge to a catenoid S with horizontal ends.

Note that for large n , there is a simple closed geodesic γ_n in S_n such that $(\gamma_n - p_n)/c_n$ converges to the waist of the catenoid S . Furthermore, γ_n is unique in the following sense: if γ'_n is a simple closed geodesic in S_n that converges to the waist of the catenoid S , then $\gamma'_n = \gamma_n$ for all sufficiently large n . (This follows from the implicit function theorem and the fact that the waist γ of the catenoid is non-degenerate as a critical point of the length function.)

Claim. $\rho_Y \gamma_n = \gamma_n$ for all sufficiently large n .

Proof of claim. Suppose not. Then (by passing to a subsequence) we can assume that $\gamma_n \neq \rho_Y \gamma_n$ for all n . Thus (passing to a further subsequence) the curves $(\rho_Y \gamma_n - p_n)/c_n$ do one of the following: (i) they converge to γ , (ii) they converge to another simple closed geodesic in S having the same length as γ , or (iii) they diverge to infinity. Now (i) is impossible by the uniqueness of the γ_n . Also, (ii) is impossible because the waist γ is the only simple closed geodesic in the catenoid S . Thus (iii) must hold: the curves $(\rho_Y \gamma_n - p_n)/c_n$ diverge to infinity.

Since S_n is a Y -surface, γ_n together with $\rho_Y \gamma_n$ bound a region A_n in S_n . By the maximum principle, $\theta(\cdot)$ restricted to A_n has its maximum on one of the two boundary curves γ_n and $\rho_Y \gamma_n$ and (by symmetry) its minimum on the other. (Note that the level sets of θ are totally geodesic and therefore minimal.)

By passing to a subsequence, we can assume that the regions $(A_n - p_n)/c_n$ converges to a subset \hat{A} of the catenoid S . Note that \hat{A} is the closure of one of the components of $S \setminus \Gamma$. (This is because one of the two boundary components of $(A_n - p_n)/c_n$, namely $(\gamma_n - p_n)/c_n$, converges to the waist of the catenoid, whereas the other boundary component, namely $(\rho_Y \gamma_n - p_n)/c_n$, diverges to infinity.) The fact that $\theta|_{\overline{A_n}}$ attains its maximum on γ_n implies that there is a linear function L

on \mathbf{R}^3 with horizontal gradient such that $L|\hat{A}$ attains its maximum on the waist $\gamma = \partial\hat{A}$. But that is impossible since the catenoid S has a horizontal waist. This proves the claim. \square

Since each γ_n is ρ_Y -invariant (by the claim), it follows that the waist γ is invariant under 180° rotation about the line Y' , where Y' is a subsequential limit of the curves $(Y_n - p_n)/c_n$. Since γ is a horizontal circle, Y' must be a line that bisects the circle. Thus

$$(37) \quad \frac{\text{dist}(p_n, S_n \cap Y)}{c_n} \rightarrow \text{dist}(O, S \cap Y') < \infty.$$

Note that $\eta_n/c_n \rightarrow \infty$, since if it converged to a finite limit, then the regions $(H_n^+ - p_n)/c_n$ would converge to a horizontal slab of finite thickness and the catenoid S would be contained in that slab, a contradiction. This completes the proof of (33).

Finally, (34) follows immediately from (33) and (37). \square

15.10. Corollary. *The singular set K in theorem 15.3 is a finite subset of Y^+ . In fact (after passing to a subsequence), $p \in K$ if and only if there is a sequence $p_n \in Y^+ \cap S_n$ such that $p_n \rightarrow p$.*

The following definition is suggested by theorem 15.9:

15.11. Definition. Let (S, η, R) be an example (as in definition 15.1). Consider the set of points of S at which the tangent plane is vertical. A *neck* of S is a connected component of that set consisting of a simple closed curve that intersects Y^+ in exactly two points. The *radius* of the neck is half the distance between those two points, and the *axis* of the neck is the vertical line that passes through the midpoint of those two points.

15.12. Theorem. *Suppose that (S, η, R) is an example (as in definition 15.1) and that V is a vertical line. If V is not too close to $Z \cup Z^*$ and also not too close to any neck axis, then V intersects M in at most two points, and the tangent planes to M at those points are nearly horizontal. Specifically, for every $\epsilon > 0$, there is a λ (depending only on genus and ϵ) with the following properties. Suppose that*

$$\frac{\text{dist}(V, Z \cup Z^*)}{\eta} \geq \lambda,$$

and that for every neck axis A , either

$$\frac{\text{dist}(V, A)}{r(A)} \geq \lambda$$

(where $r(A)$ is the neck radius) or

$$\frac{\text{dist}(V, A)}{\eta} \geq 1.$$

Then

- (i) *The slope of the tangent plane at each point in $V \cap M$ is $< \epsilon$, and*
- (ii) *V intersects \bar{S} in exactly one point if $\theta(V) > \pi/2$ and in exactly two points if $\theta(V) \leq \pi/2$.*

Proof. Let us first prove that there is a value $\Lambda < \infty$ of λ such that assertion (i) holds. Suppose not. Then there exist examples (S_n, η_n, R_n) and vertical lines V_n such that

$$(38) \quad \frac{\text{dist}(V_n, Z \cup Z^*)}{\eta_n} \geq \lambda_n \rightarrow \infty,$$

and such that

$$(39) \quad \frac{\text{dist}(V_n, A)}{r(A)} \geq \lambda_n \quad \text{or} \quad \frac{\text{dist}(V_n, A)}{\eta_n} \geq 1$$

for every neck axis A of S_n , but such that $V_n \cap S_n$ contains a point p_n at which the slope of M_n is $\geq \epsilon$.

Note that (38) and (39) are scale invariant. We can choose coordinates so that p_n is at the origin and, by theorem 15.9, we can choose scalings so that the S_n converge smoothly to a catenoid in \mathbf{R}^3 . Let A' be the axis of the catenoid, $r(A')$ be the radius of the waist of the catenoid, and V' be the vertical line through the origin. Then $\text{dist}(A', V')$ is finite, $r(A')$ is finite and nonzero, and $\eta_n \rightarrow \infty$ by (33). Thus if A_n is the neck axis of S_n that converges to A' , then

$$\lim_n \frac{\text{dist}(V_n, A_n)}{r(A_n)} < \infty \quad \text{and} \quad \lim_n \frac{\text{dist}(V_n, A_n)}{\eta_n} = 0,$$

contradicting (39). This proves that there is a value of λ , call it Λ , that makes assertion (i) of the theorem true.

Now suppose that there is no λ that makes assertion (ii) true. Then there is a sequence $\lambda_n \rightarrow \infty$, a sequence of examples (S_n, η_n, R_n) , and a sequence of vertical lines V_n such that (38) and (39) hold, but such that V_n does not intersect M_n in the indicated number of points. By scaling, we may assume that

$$1 = \text{dist}(V_n, Z) \leq \text{dist}(V_n, Z^*),$$

which implies that R_n is bounded below and (by (38)) that $\eta_n \rightarrow 0$. We may also assume that $\theta(V_n) \geq 0$, and that each λ_n is greater than Λ . Thus V_n intersects S_n transversely. For each fixed n , if we move V_n in such a way that $\text{dist}(V_n, Z) = 1$ stays constant and that $\theta(V_n)$ increases, then (38) and (39) remain true, so V_n continues to be transverse to M_n . Thus as we move V_n in that way, the number of points in $V_n \cap \overline{S_n}$ does not change unless V_n crosses X , so we may assume that $\theta(V_n) \geq \pi/4$. But now theorem 15.3 and Remark 15.4 imply that $V_n \cap \overline{S_n}$ has the indicated number of intersections, contrary to our assumption that it did not. \square

15.13. Corollary. *Let $\epsilon > 0$ and $\lambda > 1$ be as in theorem 15.12, and let (S, η, R) be an example. Consider the following cylinders: vertical solid cylinders of radius $\lambda\eta$ about Z and Z^* , and for each neck axis¹¹ A of S with $\text{dist}(A, Z \cup Z^*) > (\lambda - 1)\eta$, a vertical solid cylinder with axis A and radius $\lambda r(A)$. Let J be the union of those cylinders. Then $S \setminus J$ consists of two components, one of which can be parametrized as*

$$\{(r \cos \theta, r \sin \theta, f(r, \theta)) : r > 0, \theta \geq -\pi/2\} \setminus J$$

where $f(r, -\pi/2) \equiv 0$ and where

$$(40) \quad \eta \left(\frac{\theta}{\pi} - \frac{1}{2} \right) \leq f(r, \theta) \leq \eta \left(\frac{\theta}{\pi} + \frac{1}{2} \right).$$

¹¹See 15.11 for the definition of ‘‘neck axis’’.

Of course, by ρ_Y symmetry, the other component of $S \setminus J$ can be written

$$\{(r \cos \theta, r \sin \theta, -f(r, -\theta)) : r > 0, \quad \theta \leq \pi/2\} \setminus J.$$

The inequality (40) expresses the fact that S lies in H^+ . Note that in corollary 15.13, because we are working in the universal cover of $\mathbf{R}^3 \setminus Z$, each vertical cylinder about a neck axis in the collection J intersects H^+ in a single connected component. (If we were working in \mathbf{R}^3 , it would intersect H^+ in infinitely many components.) Thus the portion of S that lies in such a cylinder is a single catenoid-like annulus. If we were working in \mathbf{R}^3 , the portion of S in such a cylinder would be that annulus together with countably many disks above and below it.

15.14. Remark. In Corollary 15.13, the function $f(r, \theta)$ is only defined for $\theta \geq -\pi/2$. It is positive for $\theta > -\pi/2$ and it vanishes where $\theta = \pi/2$. Note that we can extend f by Schwarz reflection to get a function $f(r, \theta)$ defined for all θ :

$$\begin{aligned} f(r, \theta) &= f(r, \theta) && \text{for } \theta \geq -\pi/2, \text{ and} \\ f(r, \theta) &= -f(r, -\pi - \theta) && \text{for } \theta < -\pi/2. \end{aligned}$$

Corollary 15.13 states that, after removing the indicated cylinders, we can express S (the portion of M in H^+) as the union of two multigraphs: the graph of the original, unextended f together with the image of that graph under ρ_Y . Suppose we remove from M those cylinders together with their images under ρ_Z . Then the remaining portion of M can be expressed as the the union of two multigraphs: the graph of the extended function f (with $-\infty < \theta < \infty$) together with the image of that graph under ρ_Y .

15.15. Remark. Note that $H \setminus (Z \cup X)$ consists of four quarter-helicoids, two of which are described in the universal cover of $\mathbf{R}^3 \setminus Z$ by

$$z = \frac{\eta}{\pi} \left(\theta + \frac{\pi}{2} \right), \quad (\theta \geq -\pi/2)$$

and

$$z = \frac{\eta}{\pi} \left(\theta - \frac{\pi}{2} \right), \quad (\theta \leq \pi/2).$$

(As in the rest of this section, we are measuring θ from Y^+ rather than from X^+ .) These two quarter-helicoids overlap only in the region $-\pi/2 < \theta < \pi/2$: a vertical line in that region intersects both quarter-helicoids in points that are distance η apart, whereas any other vertical line intersects only one of the two quarter-helicoids. Roughly speaking, theorem 15.12 and corollary 15.13 say that if (S, η, R) is an example with R/η large, then S must be obtained from these two quarter-helicoids by joining them by catenoidal necks away from Z and in some possibly more complicated way near Z . The catenoidal necks lie along the Y -axis.

Figure 6 illustrates the intersection of $M = S \cup \rho_Z S$ with a vertical cylinder with axis Z . The shaded region is the intersection of the cylinder with H^+ . The intersections of the cylinder with the quarter-helicoids are represented by halflines on the boundary of the shaded region: $\theta \geq -\pi/2$ on top of the shaded region, and $\theta \leq \pi/2$ on the bottom. The radius of the cylinder is chosen so that the cylinder passes through a catenoidal neck of S that can be thought of as joining the quarter-helicoids, allowing S to make a transition from approximating one quarter helicoid to approximating to the other. The transition takes place in the region $-\pi/2 \leq \theta \leq \pi/2$.

15.16. **Behavior near Z .** In this section, we consider examples (see definition 15.1) $(S_n, 1, R_n)$ with $\eta = 1$ fixed and with $R_n \rightarrow \infty$. We will work in \mathbf{R}^3 (identified with $(\mathbf{S}^2(R_n) \times \mathbf{R}) \setminus Z^*$ by stereographic projection as described at the beginning of section 15), rather than in the universal cover of $\mathbf{R}^3 \setminus Z$.

15.17. **Theorem.** *Let $(S_n, 1, R_n)$ be a sequence of examples with $R_n \rightarrow \infty$. Let σ_n be a sequence of screw motions of \mathbf{R}^3 that map H to itself. Let*

$$M_n = \sigma_n(\overline{S_n \cup \rho_Z S_n}).$$

In other words, M_n is the full genus- g example (of which S_n is the subset in the interior of H^+) followed by the screw motion σ_n . Then (after passing to a subsequence), the M_n converge smoothly on compact sets to a properly embedded, multiplicity-one minimal surface M in \mathbf{R}^3 . Furthermore, there is a solid cylinder C about Z such that $M \setminus C$ is the union of two multigraphs.

Thus the family \mathcal{F} of all such subsequential limits M (corresponding to arbitrary sequences of M_n and σ_n) is compact with respect to smooth convergence. It is also closed under screw motions that leave H invariant. Those two facts immediately imply the following corollary:

15.18. **Corollary.** *Let \mathcal{F} be the family of all such subsequential limits. For each solid cylinder C around Z , each $M \in \mathcal{F}$, and each $p \in C \cap M$, the curvature of M at p is bounded by a constant $k(C) < \infty$ depending only on C (and genus).*

Proof of theorem 15.17. Let $0 < d_1^n < d_2^n < \dots < d_g^n$ be the distances of the points in $S_n \cap Y^+$ to the origin. By passing to a subsequence, we may assume that the limit

$$d_k := \lim_{n \rightarrow \infty} d_k^n \in [0, \infty]$$

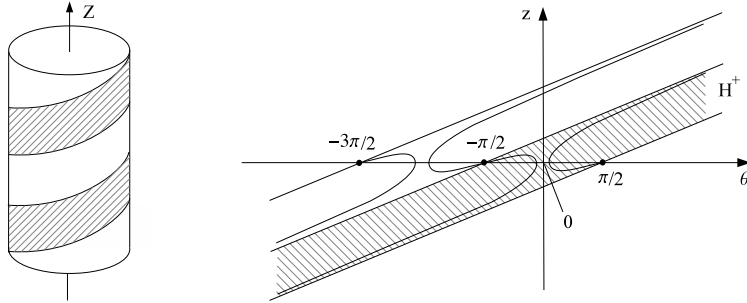

FIGURE 6. **Left:** the shaded region is the intersection of H^+ with the vertical cylinder of axis Z and radius r . **Right:** intersection of M with the same cylinder, unrolled in the plane. We use cylindrical coordinates (r, θ, z) , with $\theta = 0$ being the positive Y -axis. The radius r is chosen so that the cylinder intersects a catenoidal neck. The positive X -axis intersects the cylinder at the point $(\theta, z) = (-\pi/2, 0)$. The negative X -axis intersects the cylinder at the point $(\theta, z) = (\pi/2, 0)$, which is the same as the point $(-3\pi/2, 0)$ on the cylinder.

exists for each k . Let d be the largest finite element of $\{d_k : k = 1, \dots, g\}$. By passing to a further subsequence, we may assume that the $\sigma_n M_n$ converge as sets to a limit set M .

Let C be a solid cylinder of radius $\geq (\lambda + 1)(1 + d)$ around Z where λ is as in corollary 15.13 for $\epsilon = 1$. Let \hat{C} be any larger solid cylinder around Z . By corollary 15.13 (see also remark 15.14), for all sufficiently large n , $M_n \cap (\hat{C} \setminus C)$ is the union of two smooth multigraphs, and for each vertical line V in $\hat{C} \setminus C$, each connected component of $V \setminus H$ intersects M_n at most twice. In fact, all but one such component must intersect M_n exactly once.

By standard estimates for minimal graphs, the convergence $M_n \rightarrow M$ is smooth and multiplicity 1 in the region $\mathbf{R}^3 \setminus C$. It follows immediately that $M \setminus C$ is the union of two multigraphs, and that the area blowup set

$$Q := \{p : \limsup_{n \rightarrow \infty} \text{area}(\sigma_n M_n \cap \mathbf{B}(p, r)) = \infty \text{ for every } r > 0\}$$

is contained in C .

The halfspace theorem for area blowup sets [Whi16, 7.5] says that if an area blowup set is contained in a halfspace of \mathbf{R}^3 , then that blowup set must contain a plane. Since Q is contained in the cylinder C , it is contained in a halfspace but does not contain a plane. Thus Q must be empty. Consequently, the areas of the M_n are uniformly bounded locally. Since the genus is also bounded, we have, by the General Compactness Theorem 12.1, that M is a smooth embedded minimal hypersurface, and that either

- (1) the convergence $M_n \rightarrow M$ is smooth and multiplicity 1, or
- (2) the convergence $M_n \rightarrow M$ is smooth with some multiplicity $m > 1$ away from a discrete set. In this case, M must be stable.

Since the multiplicity is 1 outside of the solid cylinder C , it follows that the convergence $M_n \rightarrow M$ is everywhere smooth with multiplicity 1. \square

15.19. Theorem. *Suppose that in theorem 15.17, the screw motions σ_n are all the identity map. Let M be a subsequential limit of the M_n , and suppose that $M \neq H$. Then $M \cap H = X \cup Z$ and M is asymptotic to H at infinity.*

Proof. Since $M_n \cap H = X \cup Z$ for each n , the smooth convergence implies that M cannot intersect H transversely at any point not in $X \cup Z$. It follows from the strong maximum principle that M cannot touch $H \setminus (X \cup Z)$.

Since M is embedded, has finite topology, and has infinite total curvature, it follows from work by Bernstein and Breiner [Ber11] or by Meeks and Perez [MP15] that M is asymptotic to some helicoid H' at infinity. The fact that $M \cap H = X \cup Z$ implies that H' must be H .

The works of Bernstein-Breiner and Meeks-Perez quoted in the previous paragraph rely on many deep results of Colding and Minicozzi. We now give a more elementary proof that M is asymptotic to a helicoid at infinity.

According to theorem 4.1 of [HW09], a properly immersed nonplanar minimal surface in \mathbf{R}^3 with finite genus, one end, and bounded curvature must be asymptotic to a helicoid and must be conformally a once-punctured Riemann surface provided it contains $X \cup Z$ and provided it intersects some horizontal plane $\{x_3 = c\}$ in a set that, outside of a compact region in that plane, consists of two disjoint smooth embedded curves tending to ∞ . Now M contains $X \cup Z$ and has bounded curvature

(by corollary 15.18). Thus to prove theorem 15.19, it suffices to prove lemmas 15.20 and 15.21 below. \square

15.20. **Lemma.** *Let M be as in theorem 15.19. Then M has exactly one end.*

Proof. Let $Z(R)$ denote the solid cylinder with axis Z and radius R . By theorem 15.17, for all sufficiently large R , the set

$$M \setminus Z(R)$$

is the union of two connected components (namely multigraphs) that are related to each other by ρ_Z . We claim that for any such R , the set

$$(*) \quad M \setminus (Z(R) \cap \{|z| \leq R\})$$

contains exactly one connected component. To see that it has exactly one component, let \mathcal{E} be the component of $(*)$ containing $Z^+ \cap \{z > R\}$. Note that \mathcal{E} is invariant under ρ_Z . Now \mathcal{E} cannot be contained in $Z(R)$ by the maximum principle (consider catenoidal barriers). Thus \mathcal{E} contains one of the two connected components of $M \setminus Z(R)$. By ρ_Z symmetry, it must then contain both components of $M \setminus Z(R)$. It follows that if the set $(*)$ had a connected component other than \mathcal{E} , that component would have to lie in $Z(R) \cap \{z < -R\}$. But such a component would violate the maximum principle. \square

15.21. **Lemma.** *Let M be as in theorem 15.19. Then $M \cap \{z = 0\}$ is the union of X and a compact set.*

Proof. In the following argument, it is convenient to choose the angle function θ on H^+ so that $\theta = 0$ on X^+ , $\theta = \pi/2$ on Y^+ , and $\theta = \pi$ on X^- .

By theorem 15.17, for all sufficiently large R , the set

$$M \setminus Z(R)$$

is the union of two multigraphs that are related to each other by ρ_Z .

By the smooth convergence $M_n \rightarrow M$ together with corollary 15.13 and remark 15.14, one of the components of $M \setminus Z(R)$ can be parametrized as

$$(r \cos \theta, r \sin \theta, f(r, \theta)) \quad (r \geq R, \theta \in \mathbf{R})$$

where

$$(41) \quad f(r, 0) \equiv 0$$

and

$$(42) \quad \theta - \pi < f(r, \theta) < \theta + \pi.$$

(The bound (42) looks different from the bound (40) in corollary 15.13 because there we were measuring θ from Y^+ whereas here we are measuring it from X^+ .)

Of course f solves the minimal surface equation in polar coordinates.

For $0 < s < \infty$, define a function f_s by

$$f_s(r, \theta) = \frac{1}{s} f(sr, \theta).$$

Going from f to f_s corresponds to dilating S by $1/s$. (To be more precise, $(r, \theta) \mapsto (r \cos \theta, r \sin \theta, f_s(r, \theta))$ parametrizes the dilated surface.) Thus the function f_s will also solve the polar-coordinate minimal surface equation. By (42),

$$(43) \quad \theta - \pi \leq s f_s(r, \theta) \leq \theta + \pi.$$

By the Schauder estimates for f_s and by the bounds (43), the functions sf_s converge smoothly (after passing to a subsequence) as $s \rightarrow 0$ to a harmonic function $g(r, \theta)$ defined for all $r > 0$ and satisfying

$$(44) \quad \theta - \pi \leq g \leq \theta + \pi.$$

Here “harmonic” is with respect to the standard conformal structure on \mathbf{S}^2 (or equivalently on \mathbf{R}^2), so g satisfies the equation

$$g_{rr} + \frac{1}{r}g_r + \frac{1}{r^2}g_{\theta\theta} = 0.$$

Now define $G : \mathbf{R}^2 \rightarrow \mathbf{R}$ by

$$G(t, \theta) = g(e^t, \theta).$$

Then G is harmonic in the usual sense: $G_{tt} + G_{\theta\theta} = 0$.

By (44), $G(t, \theta) - \theta$ is a bounded, entire harmonic function, and therefore is constant. Also, $G - \theta$ vanishes where $\theta = 0$, so it vanishes everywhere. Thus

$$g(r, \theta) \equiv \theta,$$

and therefore $\frac{\partial}{\partial\theta}g \equiv 1$.

The smooth convergence of sf_s to g implies that

$$\lim_{r \rightarrow \infty} r \frac{\partial}{\partial\theta}f(r, \theta) = 1,$$

where the convergence is uniform given bounds on θ . Thus there is a $\rho < \infty$ such that for each $r \geq \rho$, the function

$$\theta \in [-2\pi, 2\pi] \mapsto f(r, \theta)$$

is strictly increasing. Thus it has exactly one zero in this interval, namely $\theta = 0$. But by the bounds (42), $f(r, \theta)$ never vanishes outside this interval. Hence for $r \geq \rho$, $f(r, \theta)$ vanishes if and only if $\theta = 0$.

So far we have only accounted for one component of $M \setminus Z(R)$. But the behavior of the other component follows by ρ_Z symmetry. \square

16. THE PROOF OF THEOREM 3

We now prove theorem 3 in section 2.

Proof. Smooth convergence to a surface asymptotic to H was proved in theorems 15.17 and 15.19. The other geometric properties of the surfaces M_s in statements (1) and (2) follow from the smooth convergence and the corresponding properties of the surfaces $M_s(R_n)$ in theorem 3.

Next we prove statement (3), i.e., that M_s is a Y -surface. The ρ_Y invariance of M_s follows immediately from the smooth convergence and the ρ_Y invariance of the $M_s(R_n)$. We must also show that ρ_Y acts on the first homology group of M_s by multiplication by -1 . Let γ be a closed curve in M_s . We must show that $\gamma \cup \rho_Y\gamma$ bounds a region of M_s^∞ . The curve γ is approximated by curves $\gamma_n \subset M_s(R_n)$. Since each $M_s(R_n)$ is a Y -surface, $\gamma_n \cup \rho_Y\gamma_n$ bounds a compact region in $W_n \subset M_s(R_n)$. These regions converge uniformly on compact sets to a region $W \subset M_s$ with boundary $\gamma \cup \rho_Y\gamma$ but a priori that region might not be compact. By the maximum principle, each W_n is contained in the smallest slab of the form $\{|z| \leq a\}$ containing $\gamma_n \cup \rho_Y\gamma_n$. Thus W is also contained in such a slab. Hence W is compact, since M_s contains only one end and that end is helicoidal (and therefore is not contained in a slab.) This completes the proof of statement (3).

Next we prove statement (4): $\|M_s \cap Y\| = 2\|M_s \cap Y^+\| + 1 = 2 \text{ genus}(M_s) + 1$, where $\|\cdot\|$ denotes the number of points in a set. Because M_s is a Y -surface,

$$\|M_s \cap Y\| = 2 - \chi(M_s)$$

by proposition 4.2(c). Also,

$$\chi(M_s) = 2 - 2 \text{ genus}(M_s) - 1$$

since M_s has exactly one end. Combining the last two identities gives statement (4). (Note that $M_s \cap Y$ consists of the points of $M_s \cap Y^+$, the corresponding points in $M_s \cap Y^-$, and the origin.)

Statement (5) gives bounds on the genus of M_+ and of M_- depending on the parity of g . To prove these bounds, note that $M_+(R_n) \cap Y^+$ contains exactly g points. By passing to a subsequence, we can assume (as $n \rightarrow \infty$) that a of those points stay a bounded distance from Z , that b of those points stay a bounded distance from Z^* , and that for each of the remaining $g - a - b$ points, the distance from the point to $Z \cup Z^*$ tends to infinity.

By smooth convergence,

$$\|M_+ \cap Y^+\| = a.$$

so the genus of M_+ is a by statement (4).

If g is even, then $M_+(R_n)$ is symmetric by reflection μ_E in the totally geodesic cylinder $E \times \mathbf{R}$ of points equidistant from Z and Z^* . It follows that $a = b$, so $\text{genus}(M_+) \leq a \leq g/2$. The proof for M_- and g even is identical.

If g is odd, then $M_-(R_n)$ is obtained from $M_+(R_n)$ by the reflection μ_E . Hence exactly b of the points of $M_-(R_n) \cap Y^+$ stay a bounded distance from Z . It follows that $M_- \cap Y^+$ has exactly b points, and therefore that M_- has genus b . Hence

$$\text{genus}(M_+) + \text{genus}(M_-) = a + b \leq g,$$

which completes the proof of statement (5).

It remain only to prove statement (6): the genus of M_+ is even and the genus of M_- is odd. By statement (4), this is equivalent to showing that $\|M_s \cap Y^+\|$ is even or odd according to whether s is $+$ or $-$. Let

$$S = S_s = M_s \cap H^+.$$

Then $M_s \cap Y^+ = S \cap Y$, so it suffices to show that $\|S \cap Y\|$ is even or odd according to whether s is $+1$ or -1 . By proposition 4.2, this is equivalent to showing that S has two ends if s is $+$ and one end if s is $-$.

Let $Z(R)$ be the solid cylinder of radius R about Z . By corollary 15.13 (see also the first three paragraphs of the proof of Lemma 15.21), we can choose R sufficiently large that $S \setminus Z(R)$ has two components. One component is a multigraph on which θ goes from $\theta(X^+)$ to ∞ , and on which z is unbounded above. The other component is a multigraph on which θ goes from $\theta(X^-)$ to $-\infty$ and on which z is unbounded below. In particular, if we remove a sufficiently large finite solid cylinder

$$C := Z(R) \cap \{|z| \leq A\}$$

from S , then the resulting surface $S \setminus C$ has two components. (We choose A large enough that C contains all points of $H \setminus Z$ at which the tangent plane is vertical.) One component has in its closure $X^+ \setminus C$ and $Z^+ \setminus C$, and the other component has in its closure $X^- \setminus C$ and $Z^- \setminus C$. Consequently Z^+ and X^+ belong to an end of S , and X^- and Z^- also belong to an end of S .

Thus S has one or two ends according to whether Z^+ and X^- belong to the same end of S or different ends of S . Note that they belong to the same end of S if and only if every neighborhood of O contains a path in S with one endpoint in Z^+ and the other endpoint in X^- , i.e., if and only if M_s is negative at O . By the smooth convergence, M_s is negative at O if and only if the $M_s(R_n)$ are negative at O , i.e., if and only if $s = -$. \square

17. MINIMAL SURFACES IN A THIN HEMISPHERICAL SHELL

If D is a hemisphere of radius R and J is an interval with $|J|/R$ is sufficiently small, we show that the projection of a minimal surface $M \subset D \times J$ with $\partial M \subset \partial D \times J$ onto D covers most of D . This result is used in the proof of theorem 15.3 to show that a certain multiplicity is 2, not 0.

17.1. Theorem. *Let $D = D_R$ be an open hemisphere in the sphere $\mathbf{S}^2(R)$ and let J be an interval with length $|J|$. If $|J|/R$ is sufficiently small, the following holds. Suppose that M is a nonempty minimal surface in $D \times J$ with ∂M in $(\partial D) \times J$. Then every point $p \in D$ is within distance $4|J|$ of $\Pi(M)$, where $\Pi : D \times J \rightarrow D$ is the projection map.*

Proof. By scaling, it suffices to prove that if $J = [0, 1]$ is an interval of length 1, then every point p of D_R is within distance 4 of $\Pi(M)$ provided R is sufficiently large.

For the Euclidean cylinder $\mathbf{B}^2(0, 2) \times [0, 1]$, the ratio of the area of the cylindrical side (namely 4π) to the sum of the areas of top and bottom (namely 8π) is less than 1. Thus the same is true for all such cylinders of radius 2 and height 1 in $\mathbf{S}^2(R) \times \mathbf{R}$, provided R is sufficiently large. It follows that there is a catenoid in $\mathbf{S}^2(R) \times \mathbf{R}$ whose boundary consists of the two circular edges of the cylinder.

Let $\Delta \subset D_R$ be a disk of radius 2 containing the point p . By the previous paragraph, we may suppose that R is sufficiently large that there is a catenoid C in $\Delta \times [0, 1]$ whose boundary consists of the two circular edges of $\Delta \times [0, 1]$. In other words, $\partial C = (\partial \Delta) \times (\partial[0, 1])$.

Now suppose $\text{dist}(p, \Pi(M)) > 4$. Since Δ has diameter 4, it follows that $\Pi(M)$ is disjoint from Δ and therefore that M is disjoint from C . If we slide C around in $D_R \times [0, 1]$, it can never bump into M by the maximum principle. That is, M is disjoint from the union K of all the catenoids in $D_R \times [0, 1]$ that are congruent to C . Consider all surfaces of rotation with boundary $(\partial D_R) \times (\partial[0, 1])$ that are disjoint from M and from K . The surface S of least area in that collection is a catenoid, and (because it is disjoint from K) it lies with distance 2 of $(\partial D_R) \times [0, 1]$.

We have shown: if R is sufficiently large and if the theorem is false for D_R and $J = [0, 1]$, then there is a catenoid S such that S and $\Sigma := (\partial D_R) \times [0, 1]$ have the same boundary and such that S lies within distance 2 of Σ .

Thus if the theorem were false, there would be a sequence of radii $R_n \rightarrow \infty$ and a sequence of catenoids S_n in $D_{R_n} \times [0, 1]$ such that

$$\partial S_n = \partial \Sigma_n$$

and such that S_n lies within distance 2 of Σ_n , where

$$\Sigma_n = (\partial D_{R_n}) \times [0, 1].$$

We may use coordinates in which the origin is in $(\partial D_{R_n}) \times \{0\}$. As $n \rightarrow \infty$, the Σ_n converge smoothly to an infinite flat strip $\Sigma = L \times [0, 1]$ in \mathbf{R}^3 (where L is a

straight line in \mathbf{R}^2), and the S_n converges smoothly to a minimal surface S such that (i) $\partial S = \partial \Sigma$, (ii) S has the translational invariance that Σ does, and (iii) S lies within a bounded distance of Σ . It follows that $S = \Sigma$.

Now both Σ_n and S_n are minimal surfaces. (Note that Σ_n is minimal, and indeed totally geodesic, since ∂D is a great circle.) Because Σ_n and S_n have the boundary and converge smoothly to the same limit S , it follows that there is a nonzero Jacobi field f on S that vanishes at the boundary. Since S is flat, f is in fact a harmonic function. The common rotational symmetry of Σ'_n and S'_n implies that the Jacobi field is translationally invariant along S , and thus that it achieves its maximum somewhere. (Indeed, it attains its maximum on the entire line $L \times \{1/2\}$.) But then f must be constant, which is impossible since f is nonzero and vanishes on ∂S . \square

18. NONCONGRUENCE RESULTS

In this section, we prove the noncongruence results in theorem 2: that M_+ and M_- are not congruent by any orientation-preserving isometry of $\mathbf{S}^2 \times \mathbf{R}$, and that if the genus is even, they are not congruent by any isometry of $\mathbf{S}^2 \times \mathbf{R}$. For these results, we have to assume that H does not have infinite pitch, i.e., that $H \neq X \times \mathbf{R}$. For simplicity, we consider only the non-periodic case ($h = \infty$). The periodic case is similar.

Let $s \in \{+, -\}$. Since $M_s \cap H = Z \cup Z^* \cup X$ and since every vertical line intersects H infinitely many times, we see that Z and Z^* are the only vertical lines contained in M_s .

Let C be a horizontal great circle in M_s that intersects Z and therefore also Z^* . We claim that $C = X$. To see this, first note that C must lie in $\mathbf{S}^2 \times \{0\}$, since otherwise M_s would be invariant under the screw motion $\rho_X \circ \rho_C$ and would therefore have infinite genus, a contradiction. It follows that C contains O and O^* . But then C must be X , since otherwise the tangents to C , X , and Z at O would be three linearly independent vectors all tangent to M_s at O .

Now suppose ϕ is an isometry of $\mathbf{S}^2 \times \mathbf{R}$ that maps M_+ to M_- . We must show that the genus is odd and that ϕ is orientation reversing on $\mathbf{S}^2 \times \mathbf{R}$. By composing with ρ_Y if necessary, we can assume that ϕ does not switch the two ends of $\mathbf{S}^2 \times \mathbf{R}$. Also, by the discussion above, ϕ must map $Z \cup Z^* \cup X$ to itself.

The symmetries of $Z \cup Z^* \cup X$ that do not switch up and down are: I , μ_E , μ_Y (reflection in $Y \times \mathbf{R}$), and $\mu_E \circ \mu_Y$.

The ends of M_+ and M_- are asymptotic to helicoids of positive pitch with axes Z and Z^* , which implies that the ends of $\mu_Y(M_+)$ and of $(\mu_E \circ \mu_Y)(M_+)$ are asymptotic to helicoids of negative pitch. Thus ϕ cannot be μ_Y or $\mu_E \circ \mu_Y$. Since M_+ and M_- have different signs at O , ϕ cannot be the identity. Thus ϕ must be μ_E , which is orientation reversing on $\mathbf{S}^2 \times \mathbf{R}$. Since $M_- = \phi(M_+)$ and M_+ have different signs at O , we see that $\phi(M_+)$ and M_+ are not equal, which implies (by (8) of theorem 2) that the genus is odd. \square

Part II: Genus- g Helicoids in \mathbf{R}^3

By theorem 2 (part I, section 2), for every radius $R > 0$ and positive integer g , there exist two distinct helicoidal minimal surfaces of genus $2g$ in $\mathbf{S}^2(R) \times \mathbf{R}$, with certain additional properties described below (see theorem 6). We denote those

surfaces $M_+(R)$ and $M_-(R)$. In part I, the genus of $M_s(R)$ was denoted by g and could be even or odd. In part II, we only use the examples of even genus, and it is more convenient to denote that genus by $2g$.

Let R_n be a sequence of radii diverging to infinity. By theorem 3 (part I, section 2), for each $s \in \{+, -\}$, a subsequence of $M_s(R_n)$ converges to a helicoidal minimal surface M_s in \mathbf{R}^3 . The main result of part II is the following:

Theorem 5. *If g is even, M_+ has genus g . If g is odd, M_- has genus g .*

Thus \mathbf{R}^3 contains genus- g helicoids for every g .

19. PRELIMINARIES

In this section, we recall the notations and results that we need from part I. Some notations are slightly different and better suited to the arguments of part II.

Our model for $\mathbf{S}^2(R)$ is $\mathbf{C} \cup \{\infty\}$ with the conformal metric obtained by stereographic projection:

$$(45) \quad \lambda^2 |dz|^2 \quad \text{with } \lambda = \frac{2R^2}{R^2 + |z|^2},$$

In this model, the equator is the circle $|z| = R$. Our model for $\mathbf{S}^2(R) \times \mathbf{R}$ is $(\mathbf{C} \cup \{\infty\}) \times \mathbf{R}$ with the metric

$$(46) \quad \lambda^2 |dz|^2 + dt^2, \quad (z, t) \in (\mathbf{C} \cup \{\infty\}) \times \mathbf{R}.$$

When $R \rightarrow \infty$, this metric converges to the Euclidean metric $4|dz|^2 + dt^2$ on $\mathbf{C} \times \mathbf{R} = \mathbf{R}^3$. (This metric is isometric to the standard Euclidean metric by the map $(z, t) \mapsto (2z, t)$.)

The real and imaginary axes in \mathbf{C} are denoted X and Y . The circle $|z| = R$ is denoted E (the letter E stands for “equator”). Note that X , Y and E are geodesics for the metric (45). We identify \mathbf{S}^2 with $\mathbf{S}^2 \times \{0\}$, so X , Y and E are horizontal geodesics in $\mathbf{S}^2 \times \mathbf{R}$. The antipodal points $(0, 0)$ and $(\infty, 0)$ are denoted O and O^* , respectively. The vertical axes through O and O^* in $\mathbf{S}^2 \times \mathbf{R}$ are denoted Z and Z^* , respectively. If γ is a horizontal or vertical geodesic in $\mathbf{S}^2 \times \mathbf{R}$, the 180° rotation around γ is denoted ρ_γ . This is an isometry of $\mathbf{S}^2 \times \mathbf{R}$. The reflection in the vertical cylinder $E \times \mathbf{R}$ is denoted μ_E . This is an isometry of $\mathbf{S}^2 \times \mathbf{R}$. In our model,

$$\mu_E(z, t) = \left(\frac{R^2}{\bar{z}}, t \right).$$

Let H be the standard helicoid in \mathbf{R}^3 , defined by the equation

$$x_2 \cos x_3 = x_1 \sin x_3.$$

It turns out that H is minimal for the metric (46) for any value of R , although not complete anymore (see section 1 in part I). We complete it by adding the vertical line $Z^* = \{\infty\} \times \mathbf{R}$, and still denote it H . This is a complete, genus zero, minimal surface in $\mathbf{S}^2 \times \mathbf{R}$. It contains the geodesic X , the axes Z and Z^* and meets the geodesic Y orthogonally at the points O and O^* . It is invariant by ρ_X , ρ_Z , ρ_{Z^*} , μ_E (which reverse its orientation) and ρ_Y (which preserves it).

In the following two theorems, we summarize what we need to know about the genus- $2g$ minimal surfaces $M_+(R)$ and $M_-(R)$ in $\mathbf{S}^2(R) \times \mathbf{R}$ (see theorems 2 and 3 in section 2 of part I):

Theorem 6. *Let $s \in \{+, -\}$. Then:*

- (1) $M_s(R)$ is a complete, properly embedded minimal surface with genus $2g$, and it has a top end and a bottom end, each asymptotic to H or a vertical translate of H ,
- (2) $M_s(R) \cap H = X \cup Z \cup Z^*$. In particular, $M_s(R)$ is invariant by ρ_X , ρ_Z and ρ_{Z^*} , each of which reverses its orientation.
- (3) $M_s(R)$ is invariant by the reflection μ_E , which reverses its orientation,
- (4) $M_s(R)$ meets the geodesic Y orthogonally at $4g+2$ points and is invariant under ρ_Y , which preserves its orientation. Moreover, $(\rho_Y)_*$ acts on $H_1(M_s(R), \mathbf{Z})$ by multiplication by -1 .

Theorem 7. *Let $s \in \{+, -\}$. Let R_n be a sequence of radii diverging to infinity. Let $M_s(R_n)$ be a surface having the properties listed in theorem 6. Then a subsequence of $M_s(R_n)$ converges to a minimal surface M_s in \mathbf{R}^3 asymptotic to the helicoid H . The convergence is smooth convergence on compact sets. Moreover,*

- the genus of M_s is at most g ,
- the genus of M_+ is even,
- the genus of M_- is odd,
- the number of points in $M_s \cap Y$ is $2 \text{genus}(M_s) + 1$.

20. THE SETUP

Let $R_n \rightarrow \infty$ be a sequence such that $M_s(R_n)$ converges smoothly to a limit M_s as in theorem 7. Let g' be the genus of M_s . By the last point of theorem 7, $M_s \cap Y$ has exactly $2g' + 1$ points. It follows that $2g' + 1$ points of $M_s(R_n) \cap Y$ stay at bounded distance from the origin O . By μ_E -symmetry, $2g' + 1$ points of $M_s(R_n) \cap Y$ stay at bounded distance from the antipodal point O^* . There remains $4(g - g')$ points in $M_s(R_n) \cap Y$ whose distance to O and O^* is unbounded. Let

$$N = g - g'.$$

We shall prove

20.1. Theorem. *In the above setup, $N \leq 1$.*

Theorem 5 is a straightforward consequence of this theorem: Indeed if g is even and $s = +$, we know by theorem 7 that g' is even so $N = 0$ and $g = g'$. If g is odd and $s = -$, then g' is odd so again $N = 0$.

To prove theorem 20.1, assume that $N \geq 1$. We want to prove that $N = 1$ by studying the $4N$ points whose distance to O and O^* is unbounded. To do this, it is necessary to work on a different scale. Fix a sign $s \in \{+, -\}$ and define

$$M_n = \frac{1}{R_n} M_s(R_n) \subset \mathbf{S}^2(1) \times \mathbf{R}.$$

This is a minimal surface in $\mathbf{S}^2(1) \times \mathbf{R}$. Each end of M_n is asymptotic to a vertical translate of a helicoid of pitch

$$t_n = \frac{2\pi}{R_n}.$$

(The pitch of a helicoid with counterclockwise rotation is twice the distance between consecutive sheets. The standard helicoid has pitch 2π .) Observe that $t_n \rightarrow 0$. By the definition of N , the intersection $M_n \cap Y$ has $4N$ points whose distance to O and O^* is $\gg t_n$. Because M_n is symmetric with respect to 180° rotation ρ_X around X ,

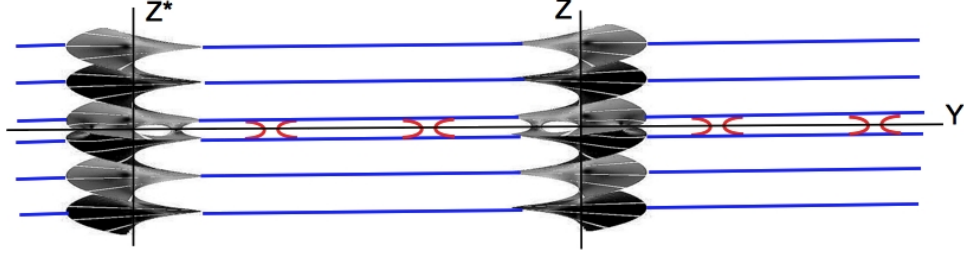

FIGURE 7. Here is a schematic illustration of what $M_s(R)$ could look like for large values of R ($g = 4$ and $s = +$ in this picture). The distance between the two vertical axes Z and Z^* is πR and should be thought of as being very large. Inside a vertical cylinder of large but fixed radius around the Z -axis, the surface is very close to the limit helicoidal surface M_s (a genus-2 helicoid in this picture). By μ_E -symmetry, the same happens around the Z^* -axis. Inside these two cylinders, we see the handles that stay at bounded distance from the axes as $R \rightarrow \infty$. Outside the cylinders, the surface is close to the helicoid (represented schematically by horizontal lines) whose two sheets are connected by $2N$ small necks placed along the Y -axis ($N = 2$ in this picture). The distance of each neck to the axes Z and Z^* is diverging as $R \rightarrow \infty$. These are the handles that are escaping from both Z and Z^* . These necks are getting smaller and smaller as $R \rightarrow \infty$ and have asymptotically catenoidal shape. Note that the handles that stay at bounded distance from the axes do not converge to catenoids as $R \rightarrow \infty$. (They do look like catenoids in this picture.)

there are $2N$ points on the positive Y -axis. We order these by increasing imaginary part:

$$p'_{1,n}, p''_{1,n}, p'_{2,n}, p''_{2,n}, \dots, p'_{N,n}, p''_{N,n}.$$

Because of the ρ_X -symmetry, the $2N$ points on the negative Y -axis are the conjugates of these points. Define $p_{j,n}$ to be the midpoint of the interval $[p'_{j,n}, p''_{j,n}]$ and $r_{j,n}$ to be half the distance from $p'_{j,n}$ to $p''_{j,n}$, both with respect to the spherical metric. We have

$$0 < \operatorname{Im} p_{1,n} < \operatorname{Im} p_{2,n} < \dots < \operatorname{Im} p_{N,n}.$$

By μ_E -symmetry, which corresponds to inversion in the unit circle,

$$(47) \quad p_{N+1-i,n} = \frac{1}{\overline{p_{i,n}}}.$$

In particular, in case N is odd, $p_{\frac{N+1}{2},n} = i$.

For $\lambda > 1$ sufficiently large, let $\mathcal{Z}_n(\lambda)$ be the part of M_n lying inside of the vertical cylinders of radius λt_n around Z and Z^* :

$$(48) \quad \mathcal{Z}_n(\lambda) = \{q = (z, t) \in M_n : d(Z \cup Z^*, q) < \lambda t_n\}.$$

Also define $D_{j,n}(\lambda) = \{z : d(z, p_{j,n}) < \lambda r_{j,n}\}$. Consider the intersection of M_n with the vertical cylinder over $D_{j,n}(\lambda)$, and let $C_{j,n}(\lambda)$ denote the component of

this intersection that contains the points $\{p'_{j,n}, p''_{j,n}\}$. Define

$$(49) \quad \mathcal{C}_n(\lambda) = \bigcup_{j=1}^N C_{j,n}(\lambda) \cup \overline{C_{j,n}(\lambda)}.$$

The following proposition is key in showing that at most one handle is lost in taking the limit as $R_n \rightarrow \infty$. In broad terms, it says that near the points $p_{j,n}$, catenoidal necks are forming on a small scale, and after removing these necks and a neighborhood of the axes, what is left is a pair of symmetric surfaces which are vertical graphs over a half-helicoid.

20.2. Proposition. *Let $N = g - g'$, t_n , and $M_n \subset \mathbf{S}^2(1) \times \mathbf{R}$ be as above. Then*

- i. *For each j , $1 \leq j \leq N$, the surface $\frac{1}{r_{j,n}}(M_n - p_{j,n})$ converges to the standard catenoid \mathbf{C} with vertical axis and waist circle of radius 1 in \mathbf{R}^3 . In particular, the distance (in the spherical metric) $d(p_{j,n}, p_{j+1,n})$ is $\gg r_{j,n}$. Moreover, $t_n \gg r_{j,n}$, and the $C_{j,n}(\lambda)$ are close to catenoidal necks with collapsing radii.*
- ii. *Given $\epsilon > 0$, there exists a $\lambda > 0$ such that*

$$M'_n = M_n \setminus (\mathcal{Z}_n(\lambda) \cup \mathcal{C}_n(\lambda))$$

has the following properties:

- (a) *The slope of the tangent plane at any point of M'_n is less than ϵ .*
- (b) *M'_n consists of two components related by the symmetry ρ_Y , rotation by 180° around Y .*
- (c) *M'_n intersects $t_n H$ in a subset of the axis X and nowhere else, with one of its components intersecting in a ray of the positive X -axis, the other in a ray of X^- . Each component is graphical over its projection onto the half-helicoid (a component of $t_n H \setminus (Z \cup Z^*)$) that it intersects.*

This proposition is proved in theorem 15.9 and corollary 15.13 of part I (with slightly different notation).

Passing to a subsequence, $p_j = \lim p_{j,n} \in i\mathbf{R}^+ \cup \{\infty\}$ exists for all $j \in [1, N]$. We have $p_1 \in [0, i]$, and we will consider the following three cases:

- Case 1: $p_1 \in (0, i)$,
 - Case 2: $p_1 = 0$,
 - Case 3: $p_1 = i$.
- (50)

We will see that Case 1 and Case 2 are impossible, and that $N = 1$ in Case 3.

20.3. The physics behind the proof of theorem 20.1. Theorem 20.1 is proved by evaluating the surface tension in the Y -direction on each catenoidal neck. Mathematically speaking, this means the flux of the horizontal Killing field tangent to the Y -circle in $\mathbf{S}^2 \times \mathbf{R}$. On one hand, this flux vanishes at each neck by ρ_Y -symmetry (see Lemma 21.3). On the other hand, we can compute the limit F_i of the surface tension on the i -th catenoidal neck (corresponding to $p_i = \lim p_{i,n}$) as $n \rightarrow \infty$, after suitable scaling.

Assume for simplicity that the points O, p_1, \dots, p_N and O^* are distinct. Recall that the points p_1, \dots, p_N are on the positive imaginary Y -axis. For $1 \leq j \leq N$, let $p_j = iy_j$, with $0 < y_j < \infty$. Then we will compute that

$$F_i = c_i^2 \frac{1 - y_i^2}{1 + y_i^2} + \sum_{j \neq i} c_i c_j f(y_i, y_j)$$

where the numbers c_i are positive and proportional to the size of the catenoidal necks and

$$f(x, y) = \frac{-2\pi^2}{(\log x - \log y) |\log x - \log y + i\pi|^2}.$$

Observe that f is antisymmetric and $f(x, y) > 0$ when $0 < x < y$. We can think of the point p_i as a particle with mass c_i and interpret F_i as a force of gravitation type. The particles p_1, \dots, p_N are attracted to each other and we can interpret the first term by saying that each particle p_i is repelled from the fixed antipodal points O and O^* . All forces F_i must vanish. It is physically clear that no equilibrium is possible unless $N = 1$ and $p_1 = i$. Indeed in any other case, $F_1 > 0$.

This strategy is similar to the one followed in [Tra04] and [Tra10]. The main technical difficulty is that we cannot guarantee that the points O, p_1, \dots, p_N and O^* are distinct. The distinction between Cases 1, 2 and 3 in (50) stems from this problem.

20.4. The space $\widetilde{\mathbf{C}}^*$. To compute forces we need to express M_n as a graph. For this, we need to express the helicoid itself as a graph, away from its axes Z and Z^* . Let $\widetilde{\mathbf{C}}^*$ be the universal cover of \mathbf{C}^* . Of course, one can identify $\widetilde{\mathbf{C}}^*$ with \mathbf{C} by mean of the exponential function. It will be more convenient to see $\widetilde{\mathbf{C}}^*$ as the covering space obtained by analytical continuation of $\log z$, so each point of $\widetilde{\mathbf{C}}^*$ is a point of \mathbf{C}^* together with a determination of its argument : points are couples $(z, \arg(z))$, although in general we just write z . The following two involutions of $\widetilde{\mathbf{C}}^*$ will be of interest:

- $(z, \arg(z)) \mapsto (\bar{z}, -\arg(z))$, which we write simply as $z \mapsto \bar{z}$. The fixed points are $\arg z = 0$.
- $(z, \arg(z)) \mapsto (1/\bar{z}, \arg(z))$, which we write simply as $z \mapsto 1/\bar{z}$. The fixed points are $|z| = 1$.

The graph of the function $\frac{t}{2\pi} \arg z$ on $\widetilde{\mathbf{C}}^*$ is one half of a helicoid of pitch t .

20.5. The domain Ω_n and the functions f_n and u_n . By proposition 20.2, away from the axes $Z \cup Z^*$ and the points $p_{j,n}$, we may consider M_n to be the union of two multigraphs. We wish to express this part of M_n as a pair of graphs over a subdomain of $\widetilde{\mathbf{C}}^*$. We will allow ourselves the freedom to write z for a point $(z, \arg z) \in \widetilde{\mathbf{C}}^*$ when its argument is clear from the context. Thus we will write $p_{j,n}$ for the point $(p_{j,n}, \pi/2)$ in $\widetilde{\mathbf{C}}^*$ corresponding to the points on $M_n \cap Y$ in proposition 20.2. Define

$$(51) \quad D_n(\lambda) = \left\{ (z, \arg z) : |z| < \lambda t_n \text{ or } |z| > \frac{1}{\lambda t_n} \right\},$$

$$(52) \quad D_{j,n}(\lambda) = \left\{ (z, \arg z) : d(p_{j,n}, z) < \lambda r_{j,n} \text{ and } 0 < \arg z < \pi \right\}$$

and

$$(53) \quad \Omega_n = \Omega_n(\lambda) = \widetilde{\mathbf{C}}^* \setminus \left(D_n(\lambda) \cup \bigcup_{j=1}^N D_{j,n}(\lambda) \cup \overline{D_{j,n}(\lambda)} \right).$$

According to statement *ii.* of proposition 20.2, there exists a $\lambda > 0$ such that for sufficiently large n ,

$$M'_n = M_n \cap (\Omega_n(\lambda) \times \mathbf{R})$$

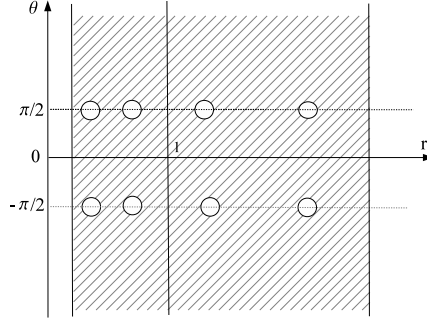

FIGURE 8. The domain Ω_n in polar coordinates, $z = re^{i\theta}$. The function u_n is positive for $\theta > 0$. The line $r = 1$ corresponds to the unit circle $|z| = 1$. The white strip on the left corresponds to the projection of the vertical cylinder of radius λt_n about the Z -axis, and the region to the right of the shaded domain is its image by the inversion through the unit circle. The small disks correspond to the vertical cylinders of radius $\lambda r_{j,n}$ (in the spherical metric).

is the union of two graphs related by ρ_Y -symmetry, and each graph intersects the helicoid of pitch t_n in a subset of the X -axis. Only one of these graphs can contain points on the positive X -axis. We choose this component and write it as the graph of a function f_n on the domain Ω_n . We may write

$$(54) \quad f_n(z) = \frac{t_n}{2\pi} \arg z - u_n(z).$$

The function u_n has the following properties:

- $u_n(\bar{z}) = -u_n(z)$. In particular, $u_n = 0$ on $\arg z = 0$.
- $u_n(1/\bar{z}) = u_n(z)$. In particular, $\partial u_n / \partial \nu = 0$ on $|z| = 1$.
- $0 < u_n < t_n/2$ when $\arg z > 0$.

The first two assertions follow from the symmetries of M_n . See theorem 6 (statements 2 and 3), and the discussion preceding it. The third assertion follows from proposition 20.2, statement *ii.c*, which implies that

$$0 < |u_n| < t_n/2$$

when $\arg z > 0$, since the vertical distance between the sheets of $t_n H$ is equal to $t_n/2$. Now choose a point z_0 in the domain of f_n that is near a point $p_{j,n}$. Then $|f_n(z_0)|$ is small, and $\arg z_0$ is near $\pi/2$. Hence $f_n(z_0) \sim t_n/4 - u_n(z_0)$, which implies that $u_n(z_0) > 0$. We conclude that $0 < u_n < t_n/2$ when $\arg z > 0$, as claimed.

Organization of part II. We deal with Cases 1, 2 and 3, as listed in (50), separately. In each case, we first state, without proof, a proposition which describes the asymptotic behavior of the function u_n defined by (54) as $n \rightarrow \infty$. We use this result to compute forces and obtain the required result (namely, $N = 1$ or a contradiction). Then, we prove the proposition. Finally, an appendix contains analytic and geometric results that are relevant to minimal surfaces in $\mathbf{S}^2 \times \mathbf{R}$ and that are used in part II.

21. CASE 1: $p_1 \in (0, i)$

For $p \in \widetilde{\mathbf{C}}^*$, let h_p be the harmonic function defined on $\widetilde{\mathbf{C}}^* \setminus \{p, \bar{p}\}$ by

$$h_p(z) = -\log \left| \frac{\log z - \log p}{\log z - \log \bar{p}} \right|.$$

Note that since p and z are in $\widetilde{\mathbf{C}}^*$, both come with a determination of their logarithm, so the function h_p is well defined. This function has the same symmetries as u_n :

- $h_p(\bar{z}) = -h_p(z)$,
- $h_p(1/\bar{z}) = h_{1/\bar{p}}(z)$.
- Moreover, if $\arg p$ and $\arg z$ are positive then $h_p(z) > 0$.

Remark. The function $(z, p) \mapsto -h_p(z)$ is the Green's function for the domain $\arg z > 0$ of $\widetilde{\mathbf{C}}^*$.

Recall that

$$(57) \quad p_i = \lim_n p_{i,n}.$$

It might happen that several points p_j are equal to p_i . In this case, we say that we have a cluster at p_i . Let m be the number of distinct points amongst p_1, \dots, p_N . For each n , relabel the points $p_{i,n}$ (by permuting the indices) so that the points p_1, \dots, p_m defined by (57) are distinct and so that

$$\operatorname{Im} p_1 < \operatorname{Im} p_2 < \dots < \operatorname{Im} p_m.$$

(Consequently, for each j with $1 \leq j \leq N$, there is exactly one i with $1 \leq i \leq m$ such that $p_j = p_i$.)

We define

$$(58) \quad \tilde{u}_n = \frac{|\log t_n|}{t_n} u_n.$$

21.1. Proposition. *Assume that $p_1 \neq 0$. Then, after passing to a subsequence, there exist non-negative real numbers c_0, \dots, c_m such that*

$$(59) \quad \tilde{u}(z) := \lim \tilde{u}_n(z) = c_0 \arg z + \sum_{i=1}^m c_i h_{p_i}(z).$$

The convergence is the usual smooth uniform convergence on compact subsets of $\widetilde{\mathbf{C}}^$ minus the points $p_i, -p_i$ for $1 \leq i \leq m$. Moreover, for $1 \leq i \leq m$,*

$$(60) \quad c_i = \lim \frac{|\log t_n|}{t_n} \frac{\phi_{i,n}}{2\pi}$$

where $\phi_{i,n}$ is the vertical flux of M_n on the graph of f_n restricted to the circle $C(p_i, \varepsilon)$ for a fixed, small enough ε .

We allow $p_1 = i$ as this proposition will be used in Case 3, section 23.

Note that for large n , $\phi_{i,n}$ is the sum of the vertical fluxes on the catenoidal necks corresponding to the points $p_{j,n}$ such that $p_j = p_i$.

This proposition is proved in section 21.10 by estimating the Laplacian of u_n and constructing an explicit barrier, from which we deduce that a subsequence converges to a limit harmonic function on $\widetilde{\mathbf{C}}^*$ with logarithmic singularities at $\pm p_1, \dots, \pm p_m$.

Remark. In proposition 21.1, it is easy to show using Harnack's inequality that we can choose numbers $\lambda_n > 0$ so that $\lambda_n u_n$ converges subsequentially to a nonzero limit of the form (59). (One fixes a point z_0 and lets $\lambda_n = 1/u_n(z_0)$.) However, for us it is crucial that we can choose λ_n to be $\frac{|\log t_n|}{t_n}$; it means that in later calculations, we will be able to ignore terms that are $o(\frac{|\log t_n|}{t_n})$.

For all we know at this point, the limit \tilde{u} might be zero. We will prove this is not the case:

21.2. Proposition. *For each $i \in [1, m]$, $c_i > 0$.*

This proposition is proved in section 21.13 using a height estimate (proposition A.5) to estimate the vertical flux of the catenoidal necks.

From now on assume that $p_1 \in (0, i)$. Fix some small number ε . Let C_n be the graph of the restriction of f_n to the circle $C(p_1, \varepsilon)$. Let F_n be the flux of the Killing field χ_Y on C_n . The field χ_Y is the Killing field associated with rotations with respect to poles whose equator is the Y -circle (see proposition A.3 in the appendix.) On one hand, we have:

21.3. Lemma. $F_n = 0$.

Proof. By theorem 6, statement (4), C_n together with its image $\rho_Y(C_n)$ bound a compact region in M_n . Thus the flux of the Killing field χ_Y on $C_n \cup \rho_Y(C_n)$ is 0. By ρ_Y -symmetry, this flux is twice the flux F_n of χ_Y on C_n . Thus $F_n = 0$. \square

On the other hand, F_n can be computed using proposition A.4 from the appendix:

$$\begin{aligned}
 F_n &= -\operatorname{Im} \int_{C(p_1, \varepsilon)} 2 \left(\frac{\partial}{\partial z} \left(\frac{t_n}{2\pi} \arg z - u_n \right) \right)^2 \frac{i}{2} (1 - z^2) dz + O(t_n^4) \\
 &= -\operatorname{Re} \int_{C(p_1, \varepsilon)} \left(\frac{t_n}{4\pi iz} - u_{n,z} \right)^2 (1 - z^2) dz + O(t_n^4) \\
 &= -\operatorname{Re} \int_{C(p_1, \varepsilon)} \left(\frac{-t_n^2}{16\pi^2 z^2} - \frac{2t_n}{4\pi iz} u_{n,z} + (u_{n,z})^2 \right) (1 - z^2) dz + O(t_n^4) \\
 (61) \quad &= \operatorname{Re} \int_{C(p_1, \varepsilon)} \left(\frac{2t_n}{4\pi iz} u_{n,z} - (u_{n,z})^2 \right) (1 - z^2) dz + O(t_n^4).
 \end{aligned}$$

The second equation comes from $\frac{\partial}{\partial z} \arg z = \frac{1}{2iz}$. The fourth equation is a consequence of the fact that $\frac{1-z^2}{z^2}$ has no residue at $p_1 \neq 0$. The first term in (61) (the cross-product) is a priori the leading term. However we can prove that this term can be neglected:

21.4. Proposition.

$$(62) \quad \lim \left(\frac{\log t_n}{t_n} \right)^2 F_n = -\operatorname{Re} \int_{C(p_1, \varepsilon)} (\tilde{u}_z)^2 (1 - z^2) dz$$

where \tilde{u} is defined in (59) as the limit of $\frac{|\log t_n|}{t_n} u_n$.

This proposition is proved in section 21.14 using a Laurent series expansion to estimate the first term in (61).

Assuming these results, we now prove

21.5. Proposition. *Case 1 is impossible.*

Proof. According to Lemma 21.3, the flux F_n is zero. Hence the limit in (62) is zero. We compute that limit and show that it is nonzero.

Differentiating equation (59), we get

$$\tilde{u}_z = \frac{c_0}{2iz} - \sum_{i=1}^m \frac{c_i}{2z} \left(\frac{1}{\log z - \log p_i} - \frac{1}{\log z - \log \bar{p}_i} \right).$$

Therefore,

$$\begin{aligned} & \text{Res}_{p_1} (\tilde{u}_z)^2 (1 - z^2) \\ &= \text{Res}_{p_1} \frac{1 - z^2}{4z^2} \left[\frac{c_1^2}{(\log z - \log p_1)^2} + 2 \frac{c_1}{\log z - \log p_1} \right. \\ & \quad \left. \left(\frac{-c_0}{i} - \frac{c_1}{\log z - \log \bar{p}_1} + \sum_{i=2}^m \frac{c_i}{\log z - \log p_i} - \frac{c_i}{\log z - \log \bar{p}_i} \right) \right] \\ &= -\frac{c_1^2(1 + p_1^2)}{4p_1} + \frac{c_1(1 - p_1^2)}{2p_1} \left(\frac{-c_0}{i} - \frac{c_1}{\log p_1 - \log \bar{p}_1} \right. \\ & \quad \left. + \sum_{i=2}^m \frac{c_i}{\log p_1 - \log p_i} - \frac{c_i}{\log p_1 - \log \bar{p}_i} \right). \end{aligned}$$

(See proposition A.9 in the appendix for the residue computations.) Write $p_j = iy_j$ for $1 \leq j \leq m$ so all y_j are positive numbers. By Lemma 21.3, equation (62) and the Residue Theorem,

$$\begin{aligned} 0 &= -\text{Re} \int_{C(p_1, \varepsilon)} (\tilde{u}_z)^2 (1 - z^2) dz \\ &= -\text{Re} \left[2\pi i \frac{y_1^2 + 1}{4iy_1} \left(c_1^2 \frac{y_1^2 - 1}{y_1^2 + 1} + 2c_1 \left(-\frac{c_0}{i} - \frac{c_1}{i\pi} \right. \right. \right. \\ & \quad \left. \left. \left. + \sum_{i=2}^m \frac{c_i}{\log y_1 - \log y_i} - \frac{c_i}{\log y_1 - \log y_i + i\pi} \right) \right) \right] \\ (63) &= \frac{\pi(y_1^2 + 1)}{2y_1} \left[c_1^2 \frac{1 - y_1^2}{y_1^2 + 1} + \sum_{i=2}^m \frac{-2\pi^2 c_1 c_i}{(\log y_1 - \log y_i) |\log y_1 - \log y_i + i\pi|^2} \right]. \end{aligned}$$

Now $y_1 < 1$ and $y_1 < y_i$ for all $i \geq 2$, so all terms in (63) are positive. This contradiction proves proposition 21.5. \square

We remark that the bracketed term in (63) is precisely the expression for the force F_1 in section 20.3.

BARRIERS

We now introduce various barriers that will be used to prove proposition 21.1. Fix some $\alpha \in (0, 1)$.

21.6. Definition. A_n is the set of points $(z, \arg z)$ in $\widetilde{\mathbf{C}}^*$ which satisfy $t_n^\alpha < |z| < 1$ and $\arg z > 0$, minus the disks $D(p_{i,n}, t_n^\alpha)$ for $1 \leq i \leq N$.

By the disk $D(p, r)$ in $\widetilde{\mathbf{C}}^*$ (for small r), we mean the points $(z, \arg z)$ such that $|z - p| < r$ and $\arg z$ is close to $\arg p$. It is clear that $A_n \subset \Omega_n$ for large n , since $t_n^\alpha \gg t_n$. Moreover, if $z \in A_n$ then $d(z, \partial\Omega_n) \geq t_n^\alpha/2$.

We work in the hemisphere $|z| \leq 1$ where the conformal factor of the spherical metric in (45) satisfies $1 \leq \lambda \leq 2$. Hence Euclidean and spherical distances are comparable. We will use Euclidean distance. Also the Euclidean and spherical Laplacians are comparable. The symbol Δ will mean Euclidean Laplacian.

Let δ be the function on A_n defined by

$$\delta(z) = \begin{cases} \min\{|z|, |z - p_{1,n}|, \dots, |z - p_{N,n}|\} & \text{if } 0 < \arg z < \pi \\ |z| & \text{if } \arg(z) \geq \pi. \end{cases}$$

21.7. Lemma. *There exists a constant C_1 such that in the domain A_n , the function u_n satisfies*

$$|\Delta u_n| \leq C_1 \frac{t_n^3}{\delta^4}.$$

Proof. The function $f_n(z) = \frac{t_n}{2\pi} \arg z - u_n(z)$ satisfies the minimal surface equation, and $|\Delta f_n| = |\Delta u_n|$. The proposition then follows from proposition A.1 in the appendix, a straightforward application of the Schauder estimates. More precisely:

- If $0 < \arg z < \pi$, we apply proposition A.1 on the domain

$$A'_n = \{w \in \Omega_n : -\pi/2 < \arg w < 3\pi/2, |w| < 2\}.$$

The distance $d(z, \partial A'_n)$ is comparable to $\delta(z)$. The function f_n is bounded by $3t_n/4$.

- If $k\pi \leq \arg z < k\pi + \pi$ for some $k \geq 1$, we apply proposition A.1 to the function $f_n - \frac{k}{2}t_n$ and the domain

$$A'_n = \{w \in \Omega_n : k\pi - \pi/2 < \arg w < k\pi + 3\pi/2, |w| < 2\}.$$

The distance $d(z, \partial A'_n)$ is comparable to $|z|$. The function $f_n - \frac{k}{2}t_n$ is again bounded by $3t_n/4$.

□

Next, we need to construct a function whose Laplacian is greater than $1/\delta^4$, in order to compensate for the fact that u_n is not quite harmonic. Let $\chi : \mathbf{R}^+ \rightarrow [0, 1]$ be a fixed, smooth function such that $\chi \equiv 1$ on $[0, \pi]$ and $\chi \equiv 0$ on $[2\pi, \infty)$.

21.8. Lemma. *There exists a constant $C_2 \geq 1$ such that the function g_n defined on A_n by*

$$g_n(z) = \frac{C_2}{|z|^2} + \chi(\arg z) \sum_{i=1}^N \frac{1}{|z - p_{i,n}|^2}$$

satisfies

$$(64) \quad \Delta g_n \geq \frac{4}{\delta^4}.$$

Moreover $\partial g_n / \partial \nu \leq 0$ on $|z| = 1$ and

$$(65) \quad g_n \leq \frac{C_2 + N}{t_n^{2\alpha}} \quad \text{in } A_n.$$

Proof. The inequality (65) follows immediately from the definitions of g_n and A_n . The function f defined in polar coordinate by $f(r, \theta) = 1/r^2$ satisfies

$$|\nabla f| = \frac{2}{r^3}, \quad \Delta f = \frac{4}{r^4}.$$

Hence for $\arg z \geq 2\pi$, (64) is satisfied for any $C_2 \geq 1$. Suppose $0 < \arg z < \pi$. Then

$$\Delta g_n = \frac{4C_2}{|z|^4} + \sum_{i=1}^N \frac{4}{|z - p_{i,n}|^4} \geq \frac{4}{\delta^4}$$

so again, (64) is satisfied for any $C_2 \geq 1$. If $\theta = \arg z \in [\pi, 2\pi]$, we have $|z - p_{i,n}| \geq |z| = r$ and

$$|\nabla \chi(\arg z)| \leq \frac{C}{r}, \quad |\Delta \chi(\arg z)| \leq \frac{C}{r^2}.$$

Hence

$$\left| \Delta \frac{\chi(\arg z)}{|z - p_{i,n}|^2} \right| \leq \frac{C}{r^2} \frac{1}{r^2} + 2 \frac{C}{r} \frac{2}{r^3} + \frac{4}{r^4}.$$

Therefore, $\Delta g_n \geq 4/r^4$ provided C_2 is large enough. (The constant C_2 only depends on N and a bound on χ' and χ'' .) This completes the proof of (64). \square

We need a harmonic function on $\widetilde{\mathbf{C}}^*$ that is greater than $|\log t|$ on $|z| = t$. A good candidate would be $-\log |z|$. However this function has the wrong Neumann data on the unit circle. We propose the following:

21.9. Lemma. *For $0 < t < 1$, the harmonic function $H_t(z)$ defined for $z \in \widetilde{\mathbf{C}}^*$, $\arg z > 0$ by*

$$H_t(z) = \operatorname{Im} \left(\frac{\log t \log z}{\log t + i \log z} \right)$$

has the following properties :

- (1) $H_t(z) > 0$ if $\arg z > 0$,
- (2) $H_t(1/\bar{z}) = H_t(z)$, hence $\partial H_t / \partial \nu = 0$ on $|z| = 1$,
- (3) $H_t(z) \geq |\log t|/2$ if $|z| = t$,
- (4) for fixed t , $H_t(z) \geq |\log t|/2$ when $\arg z \rightarrow \infty$, uniformly with respect to $|z|$ in $t \leq |z| \leq 1$,
- (5) for fixed z , $H_t(z) \rightarrow \arg z$ when $t \rightarrow 0$,
- (6) $H_t(z) \leq |\log z|$ if $\arg z > 0$.

Proof. It suffices to compute $H_t(z)$ in polar coordinates $z = re^{i\theta}$:

$$H_t(z) = \frac{(\log t)^2 \theta + |\log t|((\log r)^2 + \theta^2)}{(\log t - \theta)^2 + (\log r)^2}.$$

The first two points follow. If $r = t$ then

$$H_t(z) = \frac{|\log t|}{2} \left(1 + \frac{\theta^2}{2(\log t)^2 + 2|\log t|\theta + \theta^2} \right) \geq \frac{|\log t|}{2}$$

which proves point 3. If $t \leq r \leq 1$ then

$$H_t(z) \geq \frac{(\log t)^2 \theta + |\log t|\theta^2}{(\log t - \theta)^2 + (\log t)^2}$$

which gives point 4. Point 5 is elementary. For the last point, write

$$\left| \frac{\log t \log z}{\log t + i \log z} \right| \leq \left| \frac{\log t \log z}{\log t} \right| = |\log z|.$$

\square

21.10. **Proof of proposition 21.1.** The function \tilde{u}_n defined in (58) has the following properties in A_n :

$$(66) \quad \begin{aligned} & \bullet \quad |\Delta \tilde{u}_n| \leq C_1 \frac{t_n^2 |\log t_n|}{\delta^4} \text{ by Lemma 21.7,} \\ & \bullet \quad \tilde{u}_n \leq |\log t_n|/2, \\ & \bullet \quad \tilde{u}_n = 0 \text{ on } \arg z = 0, \\ & \bullet \quad \partial \tilde{u}_n / \partial \nu = 0 \text{ on } |z| = 1. \end{aligned}$$

The last three properties follow from (55) and the fact that $A_n \subset \Omega_n$. Consider the barrier $v_n = v_{1,n} + v_{2,n} + v_{3,n}$ where

$$\begin{aligned} v_{1,n}(z) &= -C_1 t_n^2 |\log t_n| g_n(z) + C_1 (C_2 + N) t_n^{2-2\alpha} |\log t_n|, \\ v_{2,n}(z) &= \frac{1}{\alpha} \sum_{i=1}^N h_{p_{i,n}}(z) = -\frac{1}{\alpha} \sum_{i=1}^N \log \left| \frac{\log z - \log p_{i,n}}{\log z - \log \bar{p}_{i,n}} \right|, \\ v_{3,n}(z) &= \frac{1}{\alpha} H_{t_n^\alpha}(z). \end{aligned}$$

The function $v_{1,n}$ is positive in A_n by the estimate (65) of Lemma 21.8. Observe that the second term in the expression for $v_{1,n}$ tends to 0 as $n \rightarrow \infty$ since $\alpha < 1$. The functions $v_{2,n}$ and $v_{3,n}$ are harmonic and positive in A_n (see point (1) of Lemma 21.9 for $v_{3,n}$).

By (56) and the symmetry of the set $\{p_{1,n}, \dots, p_{N,n}\}$ (see (47)), the function $v_{2,n}$ satisfies $v_{2,n}(1/\bar{z}) = v_{2,n}(z)$. Hence $\partial v_{2,n} / \partial \nu = 0$ on the unit circle. By point (2) of Lemma 21.9, $\partial v_{3,n} / \partial \nu = 0$ on the unit circle. Therefore by Lemma 21.8,

$$\frac{\partial v_n}{\partial \nu} = \frac{\partial v_{1,n}}{\partial \nu} \geq 0 \text{ on } |z| = 1.$$

Because $p_{i,n} \rightarrow p_i \neq 0$, we have on the circle $C(p_{i,n}, t_n^\alpha)$

$$\log |\log z - \log p_{i,n}| \simeq \log |z - p_{i,n}|$$

Hence for large n and for $1 \leq i \leq N$

$$v_{2,n} \geq \frac{1}{2\alpha} |\log t_n^\alpha| \geq \tilde{u}_n \quad \text{on } C(p_{i,n}, t_n^\alpha).$$

Using point (3) of Lemma 21.9 and the second statement of (66), we have $v_{3,n} \geq \tilde{u}_n$ on the boundary component $|z| = t_n^\alpha$. So we have

$$(67) \quad \begin{aligned} & \bullet \quad \Delta \tilde{u}_n \geq \Delta v_n \text{ in } A_n, \\ & \bullet \quad \tilde{u}_n \leq v_n \text{ on the boundaries } \arg z = 0, |z| = t_n^\alpha \text{ and } C(p_{i,n}, t_n^\alpha), \\ & \bullet \quad \partial \tilde{u}_n / \partial \nu \leq \partial v_n / \partial \nu \text{ on the boundary } |z| = 1, \\ & \bullet \quad \tilde{u}_n \leq v_n \text{ when } \arg z \rightarrow \infty. \end{aligned}$$

(The first statement follows from (64) and the first statement of (66).)

By the maximum principle, we have $\tilde{u}_n \leq v_n$ in A_n .

For any compact subset K of the set

$$\{z \in \widetilde{\mathbf{C}}^* : |z| \leq 1, \arg z \geq 0\} \setminus \{p_1, \dots, p_m\},$$

the function v_n is bounded by $C(K)$ on K . (For $v_{3,n}$, use the last point of Lemma 21.9.) Then by symmetry, u_n is bounded by $C(K)$ on $K \cup \overline{K} \cup \sigma(K) \cup \sigma(\overline{K})$, where σ denotes the inversion $z \mapsto \bar{z}$. Let

$$\Omega_\infty = \lim_{n \rightarrow \infty} \Omega_n = \widetilde{\mathbf{C}}^* \setminus \{\pm p_1, \dots, \pm p_m\}.$$

Then \tilde{u}_n is bounded on compact subsets of Ω_∞ . By standard PDE theory, passing to a subsequence, \tilde{u}_n has a limit \tilde{u} . The convergence is the uniform smooth convergence on compact subsets of Ω_∞ . The limit has the following properties

- \tilde{u} is harmonic in Ω_∞ . This follows from the first point of (66).
- $\tilde{u}(\bar{z}) = -\tilde{u}(z)$ and $\tilde{u}(1/\bar{z}) = \tilde{u}(z)$.
- $\tilde{u}(z) \geq 0$ if $\arg z \geq 0$.

Note that either $\tilde{u} \equiv 0$ or \tilde{u} is positive in $\arg z > 0$. Using the fact that $\log : \widetilde{\mathbf{C}}^* \rightarrow \mathbf{C}$ is biholomorphic, the following lemma tells us that \tilde{u} has the form given by equation (59).

21.11. Lemma. *Let H be the upper half plane $\operatorname{Im} z > 0$ in \mathbf{C} . Let u be a positive harmonic function in $H \setminus \{q_1, \dots, q_m\}$ with boundary value $u = 0$ on \mathbf{R} , where each $q_i \in H$. Then there exists non-negative constants c_0, \dots, c_m such that*

$$u(z) = c_0 \operatorname{Im} z - \sum_{i=1}^m c_i \log \left| \frac{z - q_i}{z - \bar{q}_i} \right|.$$

Proof. By Bôcher's Theorem ([ABR01], theorem 3.9), a positive harmonic function in a punctured disk has a logarithmic singularity at the puncture. Hence for each $1 \leq i \leq m$, there exists a non-negative constant c_i such that $u(z) + c_i \log |z - q_i|$ extends analytically at q_i . Consider the harmonic function

$$h(z) = - \sum_{i=1}^m c_i \log \left| \frac{z - q_i}{z - \bar{q}_i} \right|.$$

Observe that $h = 0$ on \mathbf{R} . Then $u - h$ extends to a harmonic function in H with boundary value 0 on \mathbf{R} . For every $\varepsilon > 0$, there exists an $r > 0$ such that $|h(z)| \leq \varepsilon$ for $|z| \geq r$. Consequently, $u - h > -\varepsilon$ for $z \in H$, $|z| \geq r$. By the maximum principle, $u - h > -\varepsilon$ in H . Since this is true for arbitrary positive ε , we conclude that $u - h$ is non negative in H . Now a non negative harmonic function in H with boundary value 0 on \mathbf{R} is equal to $c_0 \operatorname{Im} z$ for some non-negative constant c_0 ([ABR01], theorem 7.22). \square

To conclude the proof of proposition 21.1, it remains to compute the numbers c_i for $1 \leq i \leq m$. Recall that $\phi_{i,n}$ is the vertical flux of M_n on the graph of f_n restricted to the circle $C(p_i, \varepsilon)$. By proposition A.4,

$$\phi_{i,n} = \operatorname{Im} \int_{C(p_i, \varepsilon)} (2f_{n,z} + O(t_n^2)) dz = \operatorname{Im} \int_{C(p_i, \varepsilon)} (-2u_{n,z} + O(t_n^2)) dz.$$

Now

$$\begin{aligned} \lim \frac{|\log t_n|}{t_n} u_n &= -c_i \log |z - p_i| + \text{harmonic} && \text{near } p_i. \\ \lim \frac{|\log t_n|}{t_n} 2u_{n,z} &= -\frac{c_i}{z - p_i} + \text{holomorphic} && \text{near } p_i. \end{aligned}$$

Hence by the Residue Theorem,

$$\lim \frac{|\log t_n|}{t_n} \phi_{i,n} = 2\pi c_i.$$

This finishes the proof of proposition 21.1. \square

As a corollary of the proof of proposition 21.1, we have an estimate of u_n that we will need in section 23.10. For convenience, we state it here as a lemma.

Fix some $\beta \in (0, \alpha)$ and let $A'_n \subset A_n$ be the domain defined as A_n in definition 21.6, replacing α by β , namely: A'_n is the set of points $(z, \arg z)$ in $\widetilde{\mathbf{C}}^*$ which satisfy $t_n^\beta < |z| < 1$ and $\arg z > 0$, minus the disks $D(p_{i,n}, t_n^\beta)$ for $1 \leq i \leq N$.

21.12. Lemma. *Assume that $p_1 \neq 0$. Then for n large enough (depending only on β and a lower bound on $|p_1|$), we have*

$$u_n \leq (N+2) \frac{\beta}{\alpha} t_n \quad \text{in } A'_n.$$

Recalling that $u_n < t_n/2$, this lemma is useful when β is small. We will use it to get information about the level sets of u_n .

Proof. As we have seen in the proof of proposition 21.1, we have in A_n

$$(68) \quad u_n \leq \frac{t_n}{|\log t_n|} v_n = \frac{t_n}{|\log t_n|} (v_{1,n} + v_{2,n} + v_{3,n}).$$

We need to estimate the functions $v_{1,n}$, $v_{2,n}$ and $v_{3,n}$ in A'_n . We have in A_n

$$v_{1,n} \leq C_1(C_2 + N)t_n^{2-2\alpha} |\log t_n| = o(|\log t_n|).$$

By point 6 of lemma 21.9, we have in A'_n

$$v_{3,n} \leq \frac{1}{\alpha} |\log z| \leq \frac{1}{\alpha} |\log t_n^\beta| = \frac{\beta}{\alpha} |\log t_n|.$$

Regarding the function $v_{2,n}$, we need to estimate each function $h_{p_{i,n}}$ in the domain A'_n . The function $h_{p_{i,n}}$ is harmonic in the domain

$$\{z \in \widetilde{\mathbf{C}}^* : \arg z > 0, t_n^\beta < |z| < 1\} \setminus D(p_{i,n}, t_n^\beta)$$

and goes to 0 as $\arg z \rightarrow \infty$, so its maximum is on the boundary. Since $h_{p_{i,n}}(1/\bar{z}) = h_{p_{i,n}}(z)$, the maximum is not on the circle $|z| = 1$ (because it would be an interior maximum of $h_{p_{i,n}}$). Also $h_{p_{i,n}} = 0$ on $\arg z = 0$. Therefore, the maximum is either on $|z| = t_n^\beta$ or on the circle $C(p_{i,n}, t_n^\beta)$. On $|z| = t_n^\beta$, we have $h_{p_{i,n}} \rightarrow 0$ because $p_{i,n}$ is bounded away from 0. On the circle $C(p_{i,n}, t_n^\beta)$, we have for n large

$$\begin{aligned} \log z - \log p_{i,n} &\simeq \frac{1}{p_{i,n}}(z - p_{i,n}) \\ |\log z - \log p_{i,n}| &\geq \frac{t_n^\beta}{2|p_{i,n}|}. \end{aligned}$$

Hence

$$-\log |\log z - \log p_{i,n}| \leq \log(2|p_{i,n}|) + \beta |\log t_n|.$$

Also,

$$\log |\log z - \log \overline{p_{i,n}}| \leq \log(|\log z| + |\log p_{i,n}|) \simeq \log(2|\log p_{i,n}|).$$

Since $|p_{i,n}|$ is bounded away from 0, this gives for n large enough

$$h_{p_{i,n}} \leq C + \beta |\log t_n| \quad \text{in } A'_n.$$

Hence

$$v_{2,n} \leq C + N \frac{\beta}{\alpha} |\log t_n|.$$

Collecting all terms, we get, for n large enough:

$$v_n \leq C + (N+1) \frac{\beta}{\alpha} |\log t_n| \leq (N+2) \frac{\beta}{\alpha} |\log t_n| \quad \text{in } A'_n.$$

Using (68), the lemma follows. \square

21.13. Proof of proposition 21.2. We use the notation introduced at the end of the proof of proposition 21.1. Fix some index $i \leq m$ and let $J = \{j \in [1, N] : p_j = p_i\}$. By permuting the indices of the $p_{j,n}$ within the cluster J , we can assume that

$$r_{i,n} = \max\{r_{j,n} : j \in J\}.$$

(Recall from section 20 that $r_{i,n}$ is the distance (with respect to the spherical metric) from $p_{i,n}$ to the two nearest points in $M_n \cap Y$, namely the points $p'_{i,n}$ and $p''_{i,n}$.) Fix some positive ε such that $|p_j - p_i| \geq 2\varepsilon$ for $j \notin J$.

From statement *i.* of proposition 20.2, we know that near $p_{j,n}$ the surface M_n is close to a vertical catenoid with waist circle of radius $r_{j,n}$. More precisely, $\frac{1}{r_{j,n}}(M_n - p_{j,n})$ converges to the standard catenoid

$$x_3 = \cosh^{-1} \sqrt{x_1^2 + x_2^2}.$$

Since the vertical flux of the standard catenoid is 2π , we have

$$(69) \quad \phi_{i,n} \simeq 2\pi \sum_{j \in J} r_{j,n} \leq 2\pi |J| r_{i,n}.$$

Let

$$h_{j,n} = r_{j,n} \cosh^{-1}(2\lambda).$$

Observe that $h_{j,n} \ll t_n$. Consider the intersection of M_n with the plane at height $h_{j,n}$ and project it on the horizontal plane. There is one component which is close to the circle $C(p_{j,n}, 2\lambda r_{j,n})$. We call this component $\gamma_{j,n}$. Observe that $\gamma_{j,n} \subset \Omega_n$ and $f_n = h_{j,n}$ on $\gamma_{j,n}$. Let $D_{j,n}$ be the disk bounded by $\gamma_{j,n}$.

We now estimate f_n on the circle $C(p_{i,n}, \varepsilon)$. By proposition 21.1, we know that $|u_n| = O(\frac{t_n}{|\log t_n|})$. Hence $f_n = \frac{t_n}{2\pi} \arg z - u_n(z) \sim \frac{t_n}{2\pi} \arg z$ on $C(p_{i,n}, \varepsilon)$. Since $p_{i,n}$ is on the positive imaginary axis, $\arg z = \pi/2 + O(\varepsilon)$ on $C(p_{i,n}, \varepsilon)$. Hence $f_n(z) \sim \frac{t_n}{4}$ on $C(p_{i,n}, \varepsilon)$. Consequently, the level set $f_n = \frac{t_n}{8}$ inside $\Omega_n \cap D(p_{i,n}, \varepsilon)$ is a closed curve, possibly with several components. We select the component which encloses the point $p_{i,n}$ and call it Γ_n . (Note that by choosing a very slightly different height, we may assume that Γ_n is a regular curve). Let D_n be the disk bounded by Γ_n . Let

$$\Omega'_n = D_n \setminus \bigcup_{j \in J} D_{j,n}$$

Then $\Omega'_n \subset \Omega_n$.

We are now able to apply the height estimate proposition A.5 in the appendix with $r_1 = \lambda r_{i,n}$, $r_2 = \varepsilon$, $h = t_n/8 - h_{i,n} \simeq t_n/8$ and f equal to the function $f_n(z - p_{i,n}) - t_n/8$. (Observe that by proposition 20.2, statement *ii.*, we may assume that $|\nabla f_n| \leq 1$. Also the fact that $\partial f_n / \partial \nu < 0$ on $\gamma_{j,n}$ follows from the convergence to a catenoid.) We obtain

$$\frac{t_n}{8} - h_{i,n} \leq \frac{\sqrt{2}}{\pi} \phi_{i,n} \log \frac{\varepsilon}{\lambda r_{i,n}}.$$

Using (69), this gives for n large enough

$$(70) \quad \frac{t_n}{9} \leq \frac{\sqrt{2}}{\pi} \phi_{i,n} \log \frac{2\pi |J| \varepsilon}{\lambda \phi_{i,n}}$$

We claim that for n large enough,

$$(71) \quad \frac{\lambda\phi_{i,n}}{2\pi|J|\varepsilon} \geq t_n^2.$$

Indeed, suppose on the contrary that

$$w_n := \frac{\lambda\phi_{i,n}}{2\pi|J|\varepsilon} < t_n^2$$

for infinitely many values of n . Since the function $x \log \frac{1}{x}$ is increasing for $x > 0$ small enough, we have

$$w_n \log \frac{1}{w_n} < t_n^2 \log \frac{1}{t_n^2}$$

for all sufficiently large n . But (70) gives

$$Ct_n \leq w_n \log \frac{1}{w_n}$$

for some positive constant C independent of n . Combining these last two inequalities gives

$$C \leq t_n \log \frac{1}{t_n^2} = 2t_n |\log t_n|.$$

Hence $t_n |\log t_n|$ is bounded below by a positive constant. This is a contradiction since $t_n |\log t_n| \rightarrow 0$. Thus inequality (71) is proved.

Inequality (71) implies (using that $|\log t_n| = -\log t_n$, since $t_n < 1$ for n large)

$$\log \frac{2\pi|J|\varepsilon}{\lambda\phi_{i,n}} \leq |\log t_n^2|.$$

Then by (70)

$$\frac{t_n}{9} \leq \frac{2\sqrt{2}}{\pi} \phi_{i,n} |\log t_n|,$$

which implies that $\frac{|\log t_n|}{t_n} \phi_{i,n}$ is bounded below by a positive constant independent of n . Therefore, the coefficient c_i defined in (60) is positive, as desired. \square

Remark. Together with (69), this gives

$$(72) \quad r_{i,n} \geq \frac{1}{36|J|\sqrt{2}} \frac{t_n}{|\log t_n|}$$

for large n . This is a lower bound on the size of the largest catenoidal neck in the cluster corresponding to p_i . We have no lower bound for $r_{j,n}$ if $j \in J$, $j \neq i$. Conceptually, we could have $r_{j,n} = o(\frac{t_n}{|\log t_n|})$, although this seems unlikely.

21.14. Proof of proposition 21.4. Let $g_n = u_{n,z}$. We have to prove

$$\lim \left(\frac{\log t_n}{t_n} \right)^2 \operatorname{Re} \int_{C(p_1, \varepsilon)} \frac{2t_n}{4\pi iz} u_{n,z} (1-z)^2 dz = 0,$$

i.e., that

$$(73) \quad \operatorname{Re} \int_{C(p_1, \varepsilon)} \frac{1}{2iz} g_n(z) (1-z^2) dz = o\left(\frac{t_n}{(\log t_n)^2} \right).$$

Fix some α such that $0 < \alpha < \frac{1}{2}$ and some small $\varepsilon > 0$. Let J be the set of indices such that $p_j = p_1$. Consider the domain

$$A_n = D(p_1, \varepsilon) - \bigcup_{j \in J} D(p_{j,n}, t_n^\alpha) \subset \Omega_n.$$

By proposition A.1 in the appendix, we have in A_n

$$|g_{n,\bar{z}}| = \frac{1}{4} |\Delta u_n| = \frac{1}{4} |\Delta f_n| \leq C t_n^{3-4\alpha}.$$

$$|\nabla f_n| \leq C t_n^{1-\alpha}.$$

As the gradient of $t_n \arg z$ is $O(t_n)$ in A_n , this gives

$$|\nabla u_n| \leq C t_n^{1-\alpha}.$$

Hence

$$(74) \quad |g_n| \leq C t_n^{1-\alpha}.$$

Proposition A.7 gives us the formula

$$g_n(z) = g^+(z) + \sum_{j \in J} g_j^-(z) + \frac{1}{2\pi i} \int_{A_n} \frac{g_{n,\bar{z}}(w)}{w-z} dw \wedge \bar{d}w$$

where of course the functions g^+ and g_j^- depend on n .

- The function g^+ is holomorphic in $D(p_1, \varepsilon)$ so does not contribute to the integral (73).
- The last term is bounded by $C t_n^{3-4\alpha}$. (The integral of $dw \wedge \bar{d}w / (w-z)$ is uniformly convergent.) Therefore we need $3-4\alpha > 1$, namely $\alpha < \frac{1}{2}$ so that the contribution of this term to the integral is $o(t_n / (\log t_n)^2)$.
- Each function g_j^- can be expanded as $\sum_{k=1}^{\infty} \frac{a_{j,k}}{(z-p_i)^k}$ by proposition A.7. By proposition A.8, each residue $a_{j,1}$ is real. Hence

$$(75) \quad \operatorname{Re} \int_{C(p_1, \varepsilon)} \frac{1}{2iz} \frac{a_{j,1}}{(z-p_{j,n})} (1-z^2) dz = a_{j,1} \operatorname{Re} \left(\frac{2\pi i}{2ip_{j,n}} (1-p_{j,n}^2) \right) = 0$$

because $p_{j,n}$ is imaginary. Thus $a_{j,1}$ does not contribute to the integral (73).

- It remains to estimate the coefficients $a_{j,k}$ for $k \geq 2$. Using (74),

$$|a_{j,k}| = \left| \frac{1}{2\pi i} \int_{C(p_{j,n}, t_n^\alpha)} g_n(z) (z-p_{j,n})^{k-1} dz \right| \leq C t_n^{1+(k-1)\alpha}$$

If $z \in C(p_1, \varepsilon)$, then $|z-p_{j,n}| \geq \varepsilon/2$, so

$$\left| \sum_{k=2}^{\infty} a_{j,k} (z-p_{j,n})^{-k} \right| \leq C \sum_{k \geq 2} t_n^{1+(k-1)\alpha} \left(\frac{2}{\varepsilon} \right)^k \leq \frac{4C}{\varepsilon^2} t_n^{1+\alpha} \sum_{k=2}^{\infty} \left(\frac{2t_n^\alpha}{\varepsilon} \right)^{k-2}.$$

The last sum converges because $\alpha > 0$. Hence the contribution of this term to the integral is $o(t_n / (\log t_n)^2)$ as desired. \square

22. CASE 2: $p_1 = 0$

In this case we make a blow up at the origin. Let

$$R_n = \frac{1}{|p_{1,n}|}.$$

(Here we assume again that the points $p_{i,n}$ are ordered by increasing imaginary part as in section 20.) Let $\widehat{M}_n = R_n M_n$. This is a helicoidal minimal surface in $\mathbf{S}^2(R_n) \times \mathbf{R}$ with pitch

$$\widehat{t}_n = R_n t_n.$$

By choice of $p_{1,n}$, we have $|p_{1,n}| \gg t_n$, so $\lim \widehat{t}_n = 0$. Let $\widehat{\Omega}_n = R_n \Omega_n$. \widehat{M}_n is the graph on $\widehat{\Omega}_n$ of the function

$$\widehat{f}_n(z) = \frac{\widehat{t}_n}{2\pi} \arg z - \widehat{u}_n(z)$$

where

$$\widehat{u}_n(z) = R_n u_n\left(\frac{z}{R_n}\right).$$

Let $\widehat{p}_{i,n} = R_n p_{i,n}$. After passing to a subsequence,

$$(76) \quad \widehat{p}_j = \lim \widehat{p}_{j,n} \in [i, \infty]$$

exists for $j \in [1, N]$ and we have $\widehat{p}_1 = i$. Let m be the number of distinct, finite points amongst $\widehat{p}_1, \dots, \widehat{p}_N$. For each n , relabel the points $\widehat{p}_{i,n}$ (by permuting the indices) so that the points $\widehat{p}_1, \dots, \widehat{p}_m$ defined by (76) are distinct and so that

$$1 = \operatorname{Im} \widehat{p}_1 < \operatorname{Im} \widehat{p}_2 < \dots < \operatorname{Im} \widehat{p}_m.$$

22.1. Proposition. *After passing to a subsequence,*

$$\lim \frac{|\log \widehat{t}_n|}{\widehat{t}_n} \widehat{u}_n(z) = \widehat{c}_0 \arg z + \sum_{i=1}^m \widehat{c}_i h_{\widehat{p}_i}(z).$$

The convergence is the smooth uniform convergence on compact subsets of $\widetilde{\mathbf{C}}^$ minus the points $\pm \widehat{p}_i$, for $1 \leq i \leq m$. The numbers \widehat{c}_i for $1 \leq i \leq m$ are given by*

$$\widehat{c}_i = \lim \frac{|\log \widehat{t}_n|}{\widehat{t}_n} \frac{\widehat{\phi}_{i,n}}{2\pi}$$

where $\widehat{\phi}_{i,n}$ is the vertical flux of \widehat{M}_n on the graph of \widehat{f}_n restricted to the circle $C(\widehat{p}_i, \varepsilon)$, for some fixed small enough ε . Moreover, $\widehat{c}_i > 0$ for $1 \leq i \leq m$.

This proposition is proved in section 22.4. The proof is very similar to the proofs of proposition 21.1 and (for the last statement) proposition 21.2.

Fix some small $\varepsilon > 0$. Let F_n be the flux of the Killing field χ_Y on the circle $C(\widehat{p}_1, \varepsilon)$ on \widehat{M}_n . Since we are in $\mathbf{S}^2(R_n) \times \mathbf{R}$,

$$\chi_Y = \frac{i}{2} \left(1 - \frac{z^2}{R_n^2}\right).$$

$$F_n = -\operatorname{Im} \int_{C(\widehat{p}_1, \varepsilon)} 2 \left(\frac{\partial}{\partial z} \left(\frac{\widehat{t}_n}{2\pi} \arg z - \widehat{u}_n \right) \right)^2 \frac{i}{2} \left(1 - \frac{z^2}{R_n^2}\right) dz + O((\widehat{t}_n)^4).$$

Expand the square. As in Case 1, the cross product term can be neglected and since $R_n \rightarrow \infty$:

22.2. Proposition.

$$\lim \left(\frac{\log \widehat{t}_n}{\widehat{t}_n} \right)^2 F_n = - \lim \left(\frac{\log \widehat{t}_n}{\widehat{t}_n} \right)^2 \operatorname{Re} \int_{C(\widehat{p}_1, \varepsilon)} (\widehat{u}_{n,z})^2 dz.$$

(Same proof as proposition 21.4).

Assuming these results, we now prove

22.3. Proposition. *Case 2 is impossible.*

Proof. Write $\widehat{p}_j = iy_j$. By the same computation as in section 21, we get (the only difference is that there is no $(1 - z^2)$ factor)

$$- \operatorname{Re} \int_{C(\widehat{p}_1, \varepsilon)} (\widetilde{u}_z)^2 dz = \frac{\pi}{2y_1} \left(\widehat{c}_1^2 + \sum_{i=2}^m \frac{-2\pi^2 \widehat{c}_1 \widehat{c}_i}{(\log y_1 - \log y_i) |\log y_1 - \log y_i + i\pi|^2} \right).$$

Again, since $y_i > y_1$ for $i \geq 2$, all terms are positive, contradiction. \square

22.4. Proof of proposition 22.1. The setup of proposition 22.1 is the same as proposition 21.1 except that we are in $\mathbf{S}^2(R_n) \times \mathbf{R}$ with $R_n \rightarrow \infty$ instead of $\mathbf{S}^2(1) \times \mathbf{R}$, and the pitch is \widehat{t}_n . Remember that $\lim \widehat{t}_n = 0$.

From now on forget all hats: write t_n instead of \widehat{t}_n , u_n instead of \widehat{u}_n , $p_{i,n}$ instead of $\widehat{p}_{i,n}$, etc...

The proof of proposition 22.1 is substantially the same as the proofs of propositions 21.1 and 21.2. The main difference is that the equatorial circle $|z| = 1$ becomes $|z| = R_n$.

- The definition of the domain A_n is the same with $|z| < 1$ replaced by $|z| < R_n$.
- Lemma 21.7 is the same (recall that now $p_{i,n}$ means $\widehat{p}_{i,n}$).
- Lemma 21.8 is the same. The last statement must be replaced by $\partial g_n / \partial \nu \leq 0$ on $|z| = R$ for $R \geq 1$.
- Lemma 21.9 is the same, we do not change the definition of the function H_t . Instead of point 3, we need $\partial H_t / \partial \nu \geq 0$ on $|z| = R$ for $R \geq 1$. This is true by the following computation:

$$\frac{\partial H_t}{\partial r} = \frac{2 \log r (\log t)^2 (|\log t| + \theta)}{((\log t - \theta)^2 + (\log r)^2)^2}.$$

- The definition of the function \widetilde{u}_n is the same, and it has the same properties, except that the last point must be replaced by $\partial \widetilde{u}_n / \partial \nu = 0$ on $|z| = R_n$.
- The definition of the function $v_{2,n}$ is the same (with $\widehat{p}_{i,n}$ in place of $p_{i,n}$), now it is symmetric with respect to the circle $|z| = R_n$.
- At the end, K is a compact of the set $\{z \in \widetilde{\mathbf{C}}^*, \arg z \geq 0\} \setminus \{\widehat{p}_1, \dots, \widehat{p}_m\}$. The fact that $v_{2,n}$ is uniformly bounded on K requires some care, maybe, because some points $\widehat{p}_{i,n}$ are not bounded: it is true by the fact that if $\arg z$ and $\arg p$ are positive, then

$$|\log z - \log p| \leq |\log z - \log \bar{p}|.$$

- The proof of the last point is exactly the proof of proposition 21.2, working in $\mathbf{S}^2(R_n) \times \mathbf{R}$ instead of $\mathbf{S}^2(1) \times \mathbf{R}$.

\square

23. CASE 3: $p_1 = i$

Note that in this case, all points $p_{j,n}$ converge to i , for $j \in [1, N]$. Passing to a subsequence, we distinguish two sub-cases:

- Case 3a: there exists $\beta > 0$ such that $|p_{1,n} - i| \leq t_n^\beta$ for n large enough,
- Case 3b: for all $\beta > 0$, $|p_{1,n} - i| \geq t_n^\beta$ for n large enough.

(Here we assume again that the points $p_{i,n}$ are ordered by increasing imaginary part as in section 20.) Roughly speaking, in Case 3a, all points $p_{j,n}$ converge to i quickly, whereas in Case 3b, at least two ($p_{1,n}$ and $p_{N,n}$ by symmetry) converge to i very slowly. We will see (proposition 23.3) that $N = 1$ and $p_{1,n} = i$ in Case 3a, and (proposition 23.7) that Case 3b is impossible.

In both cases, we make a blowup at i as follows : Let $\varphi : \mathbf{S}^2 \rightarrow \mathbf{S}^2$ be the rotation of angle $\pi/2$ which fixes the Y circle and maps i to 0. Explicitly, in our model of $\mathbf{S}^2(1)$

$$\varphi(z) = \frac{z - i}{1 - iz}, \quad \varphi^{-1}(z) = \frac{z + i}{1 + iz}.$$

It exchanges the equator E and the great circle X . φ lifts in a natural way to an isometry $\widehat{\varphi}$ of $\mathbf{S}^2 \times \mathbf{R}$. We first apply the isometry $\widehat{\varphi}$ and then we scale by $1/\mu_n$ where the ratio μ_n goes to zero and will be chosen later, depending on the case. Let

$$\widehat{M}_n = \frac{1}{\mu_n} \widehat{\varphi}(M_n) \subset \mathbf{S}^2(1/\mu_n) \times \mathbf{R},$$

$$\widehat{\Omega}_n = \frac{1}{\mu_n} \varphi(\Omega), \quad \widehat{p}_{i,n} = \frac{1}{\mu_n} \varphi(p_{i,n}), \quad \widehat{t}_n = \frac{t_n}{\mu_n}.$$

The minimal surface \widehat{M}_n is the graph over $\widehat{\Omega}_n$ of the function

$$\widehat{f}_n(z) = \frac{1}{\mu_n} f_n(\varphi^{-1}(\mu_n z)) = \widehat{t}_n w_n(z) - \widehat{u}_n(z)$$

where

$$(77) \quad w_n(z) = \frac{1}{2\pi} \arg \left(\frac{\mu_n z + i}{1 + i\mu_n z} \right)$$

$$\widehat{u}_n(z) = \frac{1}{\mu_n} u_n(\varphi^{-1}(\mu_n z)).$$

23.1. Case 3a. In this case, fix some positive number α such that $\alpha < \min\{\beta, \frac{1}{8}\}$, and take $\mu_n = t_n^\alpha$. Then for all $j \in [1, N]$, $|p_{j,n} - i| = o(\mu_n)$, so $\lim \widehat{p}_{j,n} = 0$.

23.2. Proposition. *In Case 3a, after passing to a subsequence,*

$$(78) \quad \lim \frac{|\log t_n|}{\widehat{t}_n} (\widehat{u}_n(z) - \widehat{u}_n(z_0)) = -c(\log |z| - \log |z_0|).$$

The convergence is the uniform smooth convergence on compact subsets of $\mathbf{C} \setminus \{0\}$. (Here z_0 is an arbitrary fixed nonzero complex number.) The constant c is positive.

The proof is in section 23.9.

Remark. In fact

$$\lim \frac{|\log t_n|}{\widehat{t}_n} \widehat{u}_n(z) = \infty$$

for all z , so it is necessary to subtract something to get a finite limit. Because of this, we believe it is not possible to prove this proposition by a barrier argument

as in the proof of proposition 21.1. Instead, we will prove the convergence of the derivative $\widehat{u}_{n,z}$ using the Cauchy Pompeiu integral formula for C^1 functions.

We now prove

23.3. Proposition. *In Case 3a, $N = 1$.*

Proof. From (77),

$$w_n(z) = \frac{1}{2\pi} \left(\frac{\pi}{2} + O(\mu_n) \right) = \frac{1}{4} (1 + O(t_n^\alpha)).$$

Since $\alpha > 0$, $t_n^\alpha \rightarrow 0$ so using Equation (78) of proposition 23.2,

$$\widehat{f}_n(z) - \frac{\widehat{t}_n}{4} + \widehat{u}_n(z_0) \simeq c \frac{\widehat{t}_n}{|\log t_n|} (\log |z| - \log |z_0|).$$

From this we conclude that for n large enough, the level curves of \widehat{f}_n are convex. Back to the original scale, we have found a horizontal convex curve γ_n which encloses N catenoidal necks and is invariant under reflection in the vertical cylinder $E \times \mathbf{R}$. In particular, this curve γ_n is a graph on each side of $E \times \mathbf{R}$. Consider the domain on M_n which is bounded by γ_n and its symmetric image with respect to the Y -circle. By Alexandrov reflection (see the proof of proposition A.2 in the appendix), this domain must be symmetric with respect to the vertical cylinder $E \times \mathbf{R}$ – which we already know – and must be a graph on each side of $E \times \mathbf{R}$. This implies that the centers of all necks must be on the circle E . But $E \cap Y^+$ is a single point. Hence there is only one neck: $N = 1$. \square

23.4. Case 3b. In this case we take $\mu_n = |p_{1,n} - i|$. After passing to a subsequence, the limits

$$(79) \quad \widehat{p}_j = \lim \widehat{p}_{j,n} \in \left[\frac{-i}{2}, \frac{i}{2} \right]$$

exist for all $j \in [1, N]$. Moreover, we have

$$\widehat{p}_1 = \frac{-i}{2} \text{ and } \widehat{p}_N = \frac{i}{2}.$$

(The $\frac{1}{2}$ comes from the fact that the rotation φ distorts Euclidean lengths by the factor $\frac{1}{2}$ at i .) Let m be the number of distinct points amongst $\widehat{p}_1, \dots, \widehat{p}_N$. Observe that $m \geq 2$ because we know that \widehat{p}_1 and \widehat{p}_N are distinct. For each n , relabel the points $\widehat{p}_{i,n}$ (by permuting the indices) so that the points $\widehat{p}_1, \dots, \widehat{p}_m$ defined by (79) are distinct and so that

$$\text{Im } \widehat{p}_1 < \text{Im } \widehat{p}_2 < \dots < \text{Im } \widehat{p}_m.$$

23.5. Proposition. *In Case 3b, after passing to a subsequence,*

$$\widetilde{u}(z) := \lim \frac{|\log t_n|}{\widehat{t}_n} (\widehat{u}_n(z) - \widehat{u}_n(z_0)) = \sum_{i=1}^m -\widehat{c}_i (\log |z - \widehat{p}_i| - \log |z_0 - \widehat{p}_i|).$$

The convergence is the uniform smooth convergence on compact subsets of \mathbf{C} minus the points $\widehat{p}_1, \dots, \widehat{p}_m$. (Here z_0 is an arbitrary fixed complex number different from these points.) The constants \widehat{c}_i are positive.

The proof of this proposition is in section 23.10.

Fix some small number $\varepsilon > 0$. Let F_n be the flux of the Killing field χ_Y on the circle $C(\widehat{p}_1, \varepsilon)$ on \widehat{M}_n . Because of the scaling we are in $\mathbf{S}^2(1/\mu_n) \times \mathbf{R}$ so

$$\chi_Y(z) = \frac{i}{2}(1 - \mu_n^2 z^2).$$

Hence using proposition A.4 in the appendix,

$$(80) \quad F_n = -\operatorname{Im} \int_{C(\widehat{p}_1, \varepsilon)} 2(\widehat{t}_n w_{n,z} - \widehat{u}_{n,z})^2 \frac{i}{2}(1 - \mu_n^2 z^2) + O((\widehat{t}_n)^4).$$

Expand the square. Then as in Case 1, the cross-product term can be neglected, so the leading term is the one involving $(\widehat{u}_{n,z})^2$ and since $\mu_n \rightarrow 0$:

23.6. Proposition.

$$(81) \quad \lim \left(\frac{\log t_n}{\widehat{t}_n} \right)^2 F_n = -\lim \left(\frac{\log t_n}{\widehat{t}_n} \right)^2 \operatorname{Re} \int_{C(\widehat{p}_1, \varepsilon)} (\widehat{u}_{n,z})^2 dz.$$

This proposition is proved in section 23.11. The proof is similar to the proof of proposition 21.4.

We now prove

23.7. Proposition. *Case 3b is impossible.*

Proof. According to Lemma 21.3, the flux F_n is equal to zero. Hence the left-hand side of (81) is zero. By propositions 23.5 and 23.6,

$$(82) \quad 0 = -\operatorname{Re} \int_{C(\widehat{p}_1, \varepsilon)} (\widetilde{u}_z)^2.$$

On the other hand,

$$\begin{aligned} \widetilde{u}_z &= -\sum_{i=1}^m \frac{\widehat{c}_i}{2(z - \widehat{p}_i)} \\ \operatorname{Res}_{\widehat{p}_1} (\widetilde{u}_z)^2 &= \frac{1}{2} \sum_{i=2}^m \frac{\widehat{c}_1 \widehat{c}_i}{\widehat{p}_1 - \widehat{p}_i}. \end{aligned}$$

Write $\widehat{p}_i = iy_i$, then

$$-\int_{C(\widehat{p}_1, \varepsilon)} (\widetilde{u}_z)^2 = -\pi \sum_{i=2}^m \frac{\widehat{c}_1 \widehat{c}_i}{y_1 - y_i}.$$

Since $m \geq 2$, $y_1 < y_i$ for all $i \geq 2$ and $\widehat{c}_i > 0$ for all i by proposition 23.5, this is positive, contradicting (82). \square

This completes the proof of the main theorem, modulo the proof of propositions 23.2, 23.5 and 23.6, which were used in the analysis of Cases 3a and 3b. We prove these propositions in sections 23.9, 23.10 and 23.11 respectively, using an estimate that we prove in the next section.

23.8. **An estimate of $\int |\nabla u_n|$.** By proposition 21.1, we have, since all points $p_{j,n}$ converge to i ,

$$\lim \frac{|\log t_n|}{t_n} u_n = c_0 \arg z - c_1 \log \left| \frac{\log z - \log i}{\log z + \log i} \right|.$$

Moreover, c_1 is positive by proposition 21.2. The convergence is the smooth convergence on compact subsets of $\widehat{\mathbf{C}}^* \setminus \{i, -i\}$. From this we get, for fixed $\varepsilon > 0$,

$$(83) \quad \int_{C(i, \varepsilon)} |\nabla u_n| \leq C \frac{t_n}{|\log t_n|}.$$

Let $i \in [1, n]$ be the index such that $r_{i,n} = \max\{r_{j,n} : 1 \leq j \leq N\}$. Let $\phi_n = \phi_{i,n}$ be the vertical flux of M_n on the graph of f_n restricted to $C(p_{i,n}, \varepsilon)$. By the last point of proposition 21.1, we have

$$\phi_n \leq C \frac{t_n}{|\log t_n|}$$

for some constant C . We use proposition A.6 with $r_1 = \lambda r_{i,n}$ and $r_2 = \varepsilon$ as in the proof of proposition 21.2, and

$$r'_1 = (t_n)^{1/4}, \quad r'_2 = (t_n)^{1/8}$$

The proposition tells us that for each $j \in [1, N]$, there exists a number r , which we call $r'_{j,n}$, such that

$$(84) \quad (t_n)^{1/4} \leq r'_{j,n} \leq (t_n)^{1/8}$$

and

$$\int_{C(p_{j,n}, r'_{j,n}) \cap \Omega_n} |\nabla f_n| \leq \sqrt{8} \phi_n \left(\log \frac{\varepsilon}{\lambda r_{i,n}} \right)^{1/2} \left(\log \frac{(t_n)^{1/8}}{(t_n)^{1/4}} \right)^{-1/2}.$$

Using (72), we have

$$\log \frac{\varepsilon}{\lambda r_{i,n}} \leq \log \frac{\varepsilon |\log t_n|}{\lambda C_1 t_n} \leq C_2 |\log t_n|$$

for some positive constants C_1 and C_2 . This gives

$$\int_{C(p_{j,n}, r'_{j,n}) \cap \Omega_n} |\nabla f_n| \leq C \phi_n \leq C \frac{t_n}{|\log t_n|}.$$

Now since $|\nabla \arg z| \simeq 1$ near i ,

$$\int_{C(p_{j,n}, r'_{j,n})} t_n |\nabla \arg z| \leq C t_n^{1+1/8} = o\left(\frac{t_n}{|\log t_n|}\right).$$

Hence

$$\int_{C(p_{j,n}, r'_{j,n}) \cap \Omega_n} |\nabla u_n| \leq C \frac{t_n}{|\log t_n|}.$$

Consider the domain

$$(85) \quad U_n = D(i, \varepsilon) \setminus \bigcup_{j=1}^N \overline{D}(p_{j,n}, r'_{j,n}).$$

Since $r'_{j,n} \gg t_n \gg r_{j,n}$, we have $\overline{U}_n \subset \Omega_n$ and

$$(86) \quad d(U_n, \partial \Omega_n) \geq \frac{1}{2} (t_n)^{1/4}.$$

Also, since $\partial U_n \subset \Omega_n$,

$$\partial U_n \subset C(i, \varepsilon) \cup \bigcup_{j=1}^N (C(p_{j,n}, r'_{j,n}) \cap \Omega_n).$$

This implies

$$(87) \quad \int_{\partial U_n} |\nabla u_n| \leq C \frac{t_n}{|\log t_n|}.$$

This is the estimate we will use in the next sections.

23.9. Proof of proposition 23.2 (Case 3a). Let $\beta > 0$ be the number given by the hypothesis of case 3a. Recall that we have fixed some positive number α such that $0 < \alpha < \min\{\beta, \frac{1}{8}\}$, that $\mu_n = t_n^\alpha$, $\hat{t}_n = \frac{t_n}{\mu_n}$ and $\varphi_n = \frac{1}{\mu_n}\varphi$. Let U_n be the domain defined in (85) and $\hat{U}_n = \varphi_n(U_n)$. Since $\mu_n \gg t_n^{1/8} \geq r'_{j,n}$ by (84), we have

$$\lim \hat{U}_n = \mathbf{C}^*.$$

Since φ_n is conformal, we have, using (87) (recall the definition of \hat{u}_n in (77))

$$\int_{\partial \hat{U}_n} |\nabla \hat{u}_n| = \int_{\partial \hat{U}_n} \frac{1}{\mu_n} |\nabla(u_n \circ \varphi_n^{-1})| = \frac{1}{\mu_n} \int_{\partial U_n} |\nabla u_n| \leq C \frac{t_n}{\mu_n |\log t_n|} = C \frac{\hat{t}_n}{|\log \hat{t}_n|}.$$

Using (86), we have

$$d(\hat{U}_n, \partial \hat{\Omega}_n) \geq \frac{(t_n)^{1/4}}{4\mu_n}.$$

By standard interior estimates for the minimal surface equation (see proposition A.1 in the appendix),

$$|\Delta \hat{u}_n| = |\Delta \hat{f}_n| \leq C \frac{(\hat{t}_n)^3}{((t_n)^{1/4}/(4\mu_n))^4} = C\mu_n t_n^2 \quad \text{in } \hat{U}_n.$$

Let

$$\tilde{u}_n = \frac{|\log t_n|}{\hat{t}_n} (\hat{u}_n - \hat{u}_n(z_0)).$$

Proposition 23.2 asserts that a subsequence of the \tilde{u}_n converge to $-c(\log |z| - \log |z_0|)$, where c is a real positive constant. By the above estimates,

$$(88) \quad \int_{\partial \hat{U}_n} |\nabla \tilde{u}_n| \leq C$$

and

$$(89) \quad |\Delta \tilde{u}_n| \leq C\mu_n^2 t_n |\log t_n| \quad \text{in } \hat{U}_n.$$

Let K be a compact set of \mathbf{C}^* . For n large enough, K is included in \hat{U}_n . The Cauchy Pompeiu integral formula (see (93) in the appendix) gives for $\zeta \in K$

$$\tilde{u}_{n,z}(\zeta) = \frac{1}{2\pi i} \int_{\partial \hat{U}_n} \frac{\tilde{u}_{n,z}(z)}{z - \zeta} dz + \frac{1}{8\pi i} \int_{\hat{U}_n} \frac{\Delta \tilde{u}_n(z)}{z - \zeta} dz \wedge \bar{d}z.$$

We estimate each integral in the obvious way, using (88) in the first line and (89) in the third line:

$$\left| \int_{\partial \hat{U}_n} \frac{\tilde{u}_{n,z}}{z - \zeta} \right| \leq \frac{1}{d(\zeta, \partial \hat{U}_n)} \int_{\partial \hat{U}_n} |\nabla \tilde{u}_n| \leq \frac{C}{d(\zeta, \partial \hat{U}_n)} \rightarrow \frac{C}{|\zeta|}.$$

$$\int_{\widehat{U}_n} \frac{dx dy}{|z - \zeta|} \leq \int_{D(0, \varepsilon/\mu_n)} \frac{dx dy}{|z - \zeta|} \leq 2\pi \int_{r=0}^{2\varepsilon/\mu_n} \frac{r dr}{r} = 4\pi \frac{\varepsilon}{\mu_n}.$$

$$\left| \int_{\widehat{U}_n} \frac{\Delta \tilde{u}_n}{z - \zeta} dx dy \right| \leq C \mu_n t_n |\log t_n| \rightarrow 0.$$

Hence for n large enough, we have in K

$$|\tilde{u}_{n,z}(\zeta)| \leq \frac{C}{|\zeta|}$$

for a constant C independent of K . Passing to a subsequence, $\tilde{u}_{n,z}$ converges smoothly on compact sets of \mathbf{C}^* to a holomorphic function with a zero at ∞ and at most a simple pole at 0. (The fact that the limit is holomorphic follows from (89).) Hence

$$\lim \tilde{u}_{n,z} = \frac{c}{2z}$$

for some constant c . Recalling that $(\log |z|)_z = \frac{1}{2z}$, this gives (78) of proposition 23.2. It remains to prove that $c > 0$. Let $\widehat{\phi}_n$ be the vertical flux on the closed curve of \widehat{M}_n that is the graph of \widehat{f}_n over the circle $C(0, 1) \subset \mathbf{C}^*$. Then by the computation at the end of the proof of proposition 21.1 in section 21.10 (after Lemma 21.11),

$$\lim \frac{|\log t_n|}{\widehat{t}_n} \widehat{\phi}_n = 2\pi c.$$

Now by scaling and homology invariance of the flux, $\widehat{\phi}_n = \frac{\phi_{1,n}}{\mu_n}$, where $\phi_{1,n}$ is the vertical flux on the closed curve of M_n that is the graph of f_n over the circle $C(i, \varepsilon)$. Hence $c = c_1$ and c_1 is positive by proposition 21.1. \square

23.10. Proof of proposition 23.5 (Case 3b). Recall that in Case 3b, $\mu_n = |p_{1,n} - i|$ and for all $\beta > 0$, $\mu_n \geq t_n^\beta$ for n large enough. Let U_n be the domain defined in (85). Since $\mu_n \gg t_n^{1/8} \geq r'_{j,n}$ by (84), we have

$$\lim \widehat{U}_n = \mathbf{C} \setminus \{\widehat{p}_1, \dots, \widehat{p}_m\}.$$

(Compare with case 3a, where the limit is \mathbf{C}^* .) Define again

$$\tilde{u}_n = \frac{|\log t_n|}{\widehat{t}_n} (\widehat{u}_n - \widehat{u}_n(z_0)).$$

By the same argument as in section 23.9 we obtain that $\tilde{u}_{n,z}$ converges on compact subsets of $\mathbf{C} \setminus \{\widehat{p}_1, \dots, \widehat{p}_m\}$ to a meromorphic function with at most simple poles at $\widehat{p}_1, \dots, \widehat{p}_m$ and a zero at ∞ , so

$$\lim \tilde{u}_{n,z} = \sum_{j=1}^m \frac{\widehat{c}_j}{2(z - \widehat{p}_j)}.$$

It remains to prove that the numbers $\widehat{c}_1, \dots, \widehat{c}_m$ are positive. For $1 \leq j \leq m$, let $\widehat{\phi}_{j,n}$ be the vertical flux of \widehat{M}_n on the graph of \widehat{f}_n restricted to the circle $C(\widehat{p}_j, \varepsilon)$. Then by the computation at the end of the proof of proposition 21.1, we have

$$\lim \frac{|\log t_n|}{\widehat{t}_n} \widehat{\phi}_{j,n} = 2\pi \widehat{c}_j.$$

We will prove that \widehat{c}_j is positive by estimating the vertical flux using the height estimate as in section 21.14. Take $\beta = \frac{1}{18(N+2)}$ and let

$$B_n = \bigcup_{j=1}^N D(p_{j,n}, t_n^\beta).$$

By Lemma 21.12 with $\alpha = \frac{1}{2}$, we have for n large enough:

$$u_n \leq (N+2) \frac{\beta}{\alpha} = \frac{t_n}{9} \quad \text{in } D(i, \varepsilon) \setminus B_n.$$

(Lemma 21.12 gives us this estimate for $|z| \leq 1$. The result follows because u_n is symmetric with respect to the unit circle). Consequently, the level set $u_n = \frac{t_n}{8}$ is contained in B_n . By the hypothesis of Case 3b, for n large enough, $\mu_n \gg t_n^\beta$ so the disks $D(p_{j,n}, t_n^\beta)$ for $1 \leq j \leq m$ are disjoint. Hence B_n has at least m components. Let $\Gamma_{j,n}$ be the component of the level set $u_n = \frac{t_n}{8}$ which encloses the point $p_{j,n}$ and $D_{j,n}$ the disk bounded by $\Gamma_{j,n}$. Then $D_{j,n}$ contains no other point $p_{k,n}$ with $1 \leq k \leq m$, $k \neq j$. (It might contain points $p_{k,n}$ with $k > m$). The proof of proposition 21.2 in section 21.13 gives us a point $p_{k,n} \in D_{j,n}$ (with either $k = j$ or $k > m$ and $\widehat{p}_k = \widehat{p}_j$) such that

$$r_{k,n} \geq C \frac{t_n}{|\log t_n|}$$

for some positive constant C . Scaling by $1/\mu_n$, this implies that

$$\widehat{\phi}_{j,n} \geq 2\pi \frac{C}{2} \frac{\widehat{t}_n}{|\log \widehat{t}_n|}.$$

Hence $\widehat{c}_j > 0$. □

23.11. Proof of proposition 23.6 (Case 3b). Let $g_n = \widehat{u}_{n,z}$. We have to prove that the cross-product term in (80) can be neglected, namely:

$$\operatorname{Re} \int_{C(\widehat{p}_1, \varepsilon)} w_{n,z}(z) g_n(z) (1 - \mu_n^2 z^2) dz = o\left(\frac{\widehat{t}_n}{(\log \widehat{t}_n)^2}\right).$$

The proof of this fact is the same as the proof of proposition 21.4 in section 21.14, with the following modifications:

- $\arg z$ is replaced by the function w_n defined in (77), so its derivative $\frac{1}{2iz}$ is replaced by $w_{n,z}$.
- $1 - z^2$ is replaced by $1 - \mu_n^2 z^2$.
- t_n, u_n , etc... now have hats: $\widehat{t}_n, \widehat{u}_n$, etc...
- From

$$w_{n,z} = \frac{1}{4\pi i} \left(\frac{1}{\mu_n z + i} - \frac{i}{1 + i\mu_n z} \right)$$

we deduce that $|w_{n,z}|$ is bounded in $D(\widehat{p}_1, \varepsilon)$ and since $\widehat{p}_{j,n} \in i\mathbf{R}$, that $w_{n,z}(\widehat{p}_{j,n})$ is real, which is what we need to ensure that the term $a_{j,1}$ does not contribute to the integral (see (75)). □

APPENDIX A. AUXILIARY RESULTS

This appendix contains several results about minimal surfaces in $\mathbf{S}^2 \times \mathbf{R}$ that have been used in the proof of theorem 20.1. Some of these results are true for minimal surfaces in the Riemannian product $M \times \mathbf{R}$ where (M, g) is a 2-dimensional Riemannian manifold. These results are local, so we can assume without loss of generality that M is a domain $\Omega \subset \mathbf{C}$ equipped with a conformal metric $g = \lambda^2 |dz|^2$, where λ is a smooth positive function on $\overline{\Omega}$. Given a function f on Ω , the graph of f is a minimal surface in $M \times \mathbf{R}$ if it satisfies the minimal surface equation

$$(90) \quad \operatorname{div}_g \frac{\nabla_g f}{W} = 0 \quad \text{with } W = \sqrt{1 + \|\nabla_g f\|_g^2}$$

where the subscript g means that the quantity is computed with respect to the metric g , so for instance

$$\nabla_g f = \lambda^{-2} \nabla f, \quad \operatorname{div}_g X = \lambda^{-2} \operatorname{div}(\lambda^2 X).$$

In coordinates, (90) gives the equation

$$(91) \quad (1 + \lambda^{-2} f_y^2) f_{xx} + (1 + \lambda^{-2} f_x^2) f_{yy} - 2\lambda^{-2} f_x f_y f_{xy} + (f_x^2 + f_y^2) \left(\frac{\lambda_x}{\lambda} f_x + \frac{\lambda_y}{\lambda} f_y \right) = 0.$$

Propositions A.1, A.4, A.5 and A.6 will be formulated in this setup.

INTERIOR GRADIENT AND LAPLACIAN ESTIMATE

A.1. Proposition. *Let Ω be a domain in \mathbf{C} equipped with a smooth conformal metric $g = \lambda^2 |dz|^2$. Let $f : \Omega \rightarrow \mathbf{R}$ be a solution of the minimal surface equation (90). Assume that $|f| \leq t$ in Ω and $\|\nabla f\| \leq 1$. Then*

$$\begin{aligned} \|\nabla f(z)\| &\leq \frac{Ct}{d(z)} \\ |\Delta f(z)| &\leq \frac{Ct^3}{d(z)^4} \end{aligned}$$

for all $z \in \Omega$ such that $d(z) \geq t$. Here, $d(z)$ denotes the Euclidean distance to the boundary of Ω . The gradient and Laplacian are for the Euclidean metric. The constant C only depends on the diameter of Ω and on a bound on λ , λ^{-1} and its partial derivatives of first and second order.

Proof. Let us write the minimal surface equation (91) as $L(f) = 0$, where L is a second order linear elliptic operator whose coefficients depend on f_x and f_y . Theorem 12.4 in Gilbarg-Trudinger [GT01] gives us a uniform constant C and $\alpha > 0$ such that (with the Gilbarg-Trudinger notation)

$$[Df]_\alpha^{(1)} \leq C \|f\|_0 \leq Ct.$$

If $d(z, \partial\Omega) \geq t$, this implies

$$[Df]_\alpha^{(0)} \leq \frac{Ct}{t} = C.$$

Then we have the required C^α estimates of the coefficients of L to apply the interior Schauder estimate (theorem 6.2 in [GT01]):

$$|D^k f(z)| \leq \frac{C}{d(z)^k} \|f\|_0 \leq C \frac{t}{d(z)^k}, \quad k = 0, 1, 2.$$

The minimal surface equation (91) implies

$$|\Delta f| \leq C(|Df|^2|D^2f| + |Df|^3) \leq C\frac{t^3}{d^4}.$$

□

ALEXANDROV MOVING PLANES

We may use the Alexandrov reflection technique in $\mathbf{S}^2 \times \mathbf{R}$ with the role of horizontal planes played by the level spheres $\mathbf{S}^2 \times \{t\}$, and the role of vertical planes played by a family of totally geodesic cylinders. Specifically, let $E \subset \mathbf{S}^2 \times \{0\}$ be the closed geodesic that is the equator with respect to the antipodal points O, O^* , let $X \subset \mathbf{S}^2 \times \{0\}$ be a geodesic passing through O and O^* , and define E_θ to be the rotation of $E = E_0$ through an angle θ around the poles $E \cap X$. The family of geodesic cylinders

$$E_\theta \times \mathbf{R}, \quad -\pi/2 \leq \theta < \pi/2,$$

when restricted to the complement of $(E \cap X) \times \mathbf{R}$ is a foliation.

A.2. Proposition. *Let $\Gamma = \gamma_1 \cup \gamma_2$ with each γ_i a C^2 Jordan curve in $\mathbf{S}^2 \times \{t_i\}$, $t_1 \neq t_2$, that is invariant under reflection in $\Pi = E \times \mathbf{R}$. Suppose further that each component of $\gamma_i \setminus \Pi$ is a graph over Π with locally bounded slope. Then any minimal surface Σ with $\partial\Sigma = \Gamma$ that is disjoint from at least one of the vertical cylinders $E_\theta \times \mathbf{R}$, must be symmetric with respect to reflection in Π , and each component of $\Sigma \setminus \Pi$ is a graph of locally bounded slope over a domain in Π .*

(Given a domain $\mathcal{O} \subset \Pi$ and a function $f : \mathcal{O} \rightarrow [-\pi/2, \pi/2)$, the graph of f is the set of points $\{\text{rot}_{f(p)}p : p \in \mathcal{O}\}$, where rot_θ is the rotational symmetry that takes Π to $E_\theta \times \mathbf{R}$.)

The proof is the same as the classical proof for minimal surfaces in \mathbf{R}^3 using Alexandrov reflection as described above. (See, for example, [Sch83] corollary 2.)

FLUX

Let N be a Riemannian manifold, $M \subset N$ a minimal surface and χ a Killing field on N . Let γ be a closed curve on M and μ be the conormal along γ . Define

$$\text{Flux}_\chi(\gamma) = \int_\gamma \langle \mu, \chi \rangle ds.$$

It is well know that this only depends on the homology class of γ .

A.3. Proposition. *In the case $N = \mathbf{S}^2(R) \times \mathbf{R}$, the space of Killing fields is 4 dimensional. It is generated by the vertical unit vector ξ , and the following three horizontal vectors fields:*

$$\begin{aligned} \chi_X(z) &= \frac{1}{2} \left(1 + \frac{z^2}{R^2}\right) \\ \chi_Y(z) &= \frac{i}{2} \left(1 - \frac{z^2}{R^2}\right) \\ \chi_E(z) &= \frac{iz}{R}. \end{aligned}$$

These vector fields are respectively unitary tangent to the great circles X, Y , and E . They are generated by the one-parameter families of rotations about the poles whose equators are these great circles.

Proof. The isometry group of $\mathbf{S}^2(R) \times \mathbf{R}$ is well known to be 4-dimensional. Recall that our model of $\mathbf{S}^2(R)$ is $\mathbf{C} \cup \infty$ with the conformal metric $\frac{2R^2}{R^2+|z|^2}|dz|$. By differentiating the 1-parameter group $z \mapsto e^{it}z$ of isometries of \mathbf{S}^2 , we obtain the horizontal Killing field $\chi(z) = iz$, which suitably normalized gives χ_E . Let

$$\varphi(z) = \frac{Rz + iR^2}{iz + R}.$$

This corresponds, in our model of $\mathbf{S}^2(R)$, to the rotation about the x -axis of angle $\pi/2$. It maps the great circle E to the great circle X . We transport χ_E by this isometry to get the Killing field χ_X : a short computation gives

$$\chi_X(z) = \varphi_*\chi_E(z) = \varphi'(\varphi^{-1}(z))\chi_E(\varphi^{-1}(z)) = \frac{z^2 + R^2}{2R^2}.$$

Then we transport χ_X by the rotation $\psi(z) = iz$ to get the Killing field χ_Y :

$$\chi_Y(z) = \psi_*\chi_X(z) = i\frac{(-iz)^2 + R^2}{2R^2}.$$

□

A.4. Proposition. *Let $\Omega \subset \mathbf{C}$ be a domain equipped with a conformal metric $g = \lambda^2|dz|^2$. Let $f : \Omega \rightarrow \mathbf{R}$ be a solution of the minimal surface equation (90). Let γ be a closed, oriented curve in Ω and ν be the Euclidean exterior normal vector along γ (meaning that (γ', ν) is a negative orthonormal basis). Let M be the graph of f and let $\tilde{\gamma}$ be the closed curve in M that is the graph of f over γ .*

(1) *For the vertical unit vector ξ ,*

$$\text{Flux}_\xi(\tilde{\gamma}) = \int_\gamma \frac{\langle \nabla f, \nu \rangle}{W}$$

where W is defined in equation (90). (Here the gradient, scalar product and line element are Euclidean.) If $\|\nabla f\|$ is small, this gives

$$\text{Flux}_\xi(\tilde{\gamma}) = \text{Im} \int_\gamma (2f_z + O(|f_z|^2)) dz$$

(2) *If χ is a horizontal Killing field,*

$$\text{Flux}_\chi(\tilde{\gamma}) = -\text{Im} \int_\gamma (2(f_z)^2\chi(z) + O(|f_z|^4)) dz.$$

Proof. Let (N, g) be the Riemannian manifold $\Omega \times \mathbf{R}$ equipped with the product metric $g = \lambda^2|dz|^2 + dt^2$. Let M be the graph of f , parametrized by

$$\psi(x, y) = (x, y, f(x, y)).$$

The unit normal vector to M is

$$n = \frac{1}{W} (-\lambda^{-2}f_x, -\lambda^{-2}f_y, 1).$$

Assume that γ is given by some parametrization $t \mapsto \gamma(t)$, fix some time t and let $(X, Y) = \gamma'(t)$. Then

$$d\psi(\gamma') = (X, Y, Xf_x + Yf_y)$$

is tangent to $\psi(\gamma)$ and its norm is ds , the line element on M . We need to compute the conormal vector in N . The linear map $\varphi : (T_p N, g) \rightarrow (\mathbf{R}^3, \text{Euclidean})$ defined by

$$\varphi(u_1, u_2, u_3) = (\lambda u_1, \lambda u_2, u_3)$$

is an isometry. Let $u = (u_1, u_2, u_3)$ and $v = (v_1, v_2, v_3)$ be two orthogonal vectors in $T_p N$. Let

$$w = \varphi^{-1}(\varphi(u) \wedge \varphi(v)) = \begin{pmatrix} u_2 v_3 - u_3 v_2 \\ u_3 v_1 - u_1 v_3 \\ \lambda^2(u_1 v_2 - u_2 v_1) \end{pmatrix}.$$

Then (u, v, w) is a direct orthogonal basis of $T_p N$ and $\|w\| = \|u\| \|v\|$. We use this with $u = d\psi(\gamma')$, $v = n$. Then $w = \mu ds$, where μ is the conormal to $\psi(\gamma')$. This gives

$$\mu ds = \frac{1}{W} \begin{pmatrix} Y + \lambda^{-2} f_y (X f_x + Y f_y) \\ -X - \lambda^{-2} f_x (X f_x + Y f_y) \\ -f_y X + f_x Y \end{pmatrix}.$$

For the vertical unit vector $\xi = (0, 0, 1)$, this gives

$$\text{Flux}_\xi(\tilde{\gamma}) = \int_\gamma \frac{-f_y dx + f_x dy}{W} = \int_\gamma \frac{\langle \nabla f, \nu \rangle}{W}.$$

The second formula of point (1) follows from $W = 1 + O(\|\nabla f\|^2)$ and

$$\text{Im}(2f_z dz) = \text{Im}((f_x - i f_y)(dx + i dy)) = f_x dy - f_y dx.$$

To prove point (2), let χ be a horizontal Killing field, seen as a complex number. Then

$$\langle \chi, \mu ds \rangle_g = \lambda^2 \text{Re} \left(\frac{\chi}{W} (Y + iX + \lambda^{-2} (f_y + i f_x)(X f_x + Y f_y)) \right)$$

Hence

$$\text{Flux}_\chi(\tilde{\gamma}) = \text{Re} \int_\gamma \frac{\lambda^2 \chi}{W} (dy + i dx) + \frac{\chi}{W} (f_y + i f_x)(f_x dx + f_y dy).$$

We then expand $1/W$ as a series

$$\frac{1}{W} = 1 - \frac{1}{2} \lambda^{-2} (f_x^2 + f_y^2) + O(|\nabla f|^4).$$

This gives after some simplifications

$$\text{Flux}_\chi(\tilde{\gamma}) = \text{Re} \int_\gamma \lambda^2 \chi (dy + i dx) + \text{Re} \int_\gamma \frac{i}{2} \chi (f_x - i f_y)^2 (dx + i dy) + O(|\nabla f|^4).$$

The second term is what we want. The first term, which does not depend on f , vanishes. Indeed, if $f \equiv 0$ then M is $\Omega \times \{0\}$ and the flux we are computing is zero (by homology invariance of the flux, say). \square

HEIGHT ESTIMATE

The following proposition tells us that a minimal graph with small vertical flux cannot climb very high. It is the key to estimate from below the size of the catenoidal necks.

A.5. Proposition. *Let $\Omega \subset \mathbf{C}$ be a domain that consists of a (topological) disk D minus $n \geq 1$ topological disks D_1, \dots, D_n contained in D . We denote by Γ the boundary of D and by γ_i the boundary of D_i . Assume that D_1 contains $D(0, r_1)$ and D is contained in $D(0, r_2)$, for some numbers $0 < r_1 < r_2$. (Here r_1, r_2 are Euclidean lengths). (See Figure 9).*

Assume that Ω is equipped with a conformal metric $g = \lambda^2 |dz|^2$. Let $f : \Omega \rightarrow \mathbf{R}$ be a solution of the minimal surface equation (90). Assume that

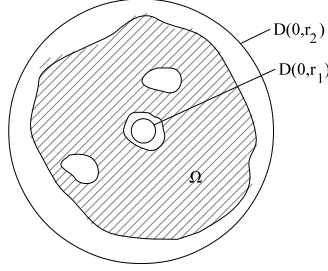

FIGURE 9.

- (1) $f \equiv 0$ on Γ .
- (2) $f \equiv -h < 0$ is constant on γ_1 .
- (3) f is constant on γ_i for $2 \leq i \leq n$, with $-2h \leq f \leq 0$.
- (4) $\partial f / \partial \nu \leq 0$ on γ_i for $1 \leq i \leq n$.
- (5) $\|\nabla_g f\|_g \leq 1$ in Ω

Let ϕ be the vertical flux on Γ :

$$\phi = \int_{\Gamma} \frac{\langle \nabla f, \nu \rangle}{W} > 0.$$

Then

$$h \leq \frac{\sqrt{2}}{\pi} \phi \log \frac{r_2}{r_1}.$$

(Note that Hypothesis (4) is always satisfied if $f \equiv -h$ on all γ_i by the maximum principle.)

Proof. Let A be the annulus $D(0, r_2) \setminus D(0, r_1)$. Write $|df|$ for the norm of the Euclidean gradient of f . Let ρ be the function equal to $|df|$ on Ω and 0 on $\mathbf{C} \setminus \Omega$. Then

$$\begin{aligned} \iint_A \rho^2 dx dy &= \iint_{\Omega} \|\nabla_g f\|_g^2 d\mu_g \quad \text{by conformal invariance of the energy} \\ &\leq \sqrt{2} \iint_{\Omega} \left\langle \frac{\nabla_g f}{W}, \nabla_g f \right\rangle_g d\mu_g \quad \text{because } W \leq \sqrt{2} \text{ by hypothesis (5)} \\ &= \sqrt{2} \iint_{\Omega} \operatorname{div}_g \left(f \frac{\nabla_g f}{W} \right) d\mu_g \quad \text{by the minimal surface equation (90)} \\ &= \sqrt{2} \int_{\partial\Omega} \frac{f}{W} \langle \nabla_g f, \nu_g \rangle_g ds_g \quad \text{by the divergence theorem} \\ &= \sqrt{2} \int_{\partial\Omega} \frac{f}{W} \langle \nabla f, \nu \rangle \quad \text{where now all quantities are Euclidean} \\ &= \sqrt{2} \sum_{i=1}^n \int_{\gamma_i} \frac{f}{W} \langle \nabla f, \nu \rangle \quad \text{by hypothesis (1)} \\ &\leq -2\sqrt{2}h \sum_{i=1}^n \int_{\gamma_i} \frac{\langle \nabla f, \nu \rangle}{W} \quad \text{by hypotheses (3) and (4)}. \end{aligned}$$

Hence by homology invariance of the flux,

$$(92) \quad \iint_A \rho^2 dx dy \leq 2\sqrt{2}h\phi.$$

Consider the ray from $r_1 e^{i\theta}$ to $r_2 e^{i\theta}$. The integral of df along this ray, intersected with Ω , is equal to h . (If the ray happens to enter one of the disks D_i , then this is true because f is constant on ∂D_i .) Integrating for $\theta \in [0, 2\pi]$ we get

$$\begin{aligned} 2\pi h &\leq \int_{r=r_1}^{r_2} \int_{\theta=0}^{2\pi} \rho dr d\theta \\ &= \int_A \frac{\rho}{r} dx dy \\ &\leq \left(\iint_A \rho^2 dx dy \right)^{1/2} \left(\iint_A \frac{1}{r^2} dx dy \right)^{1/2} \quad \text{by Cauchy Schwarz} \\ &\leq \left(2\sqrt{2}h\phi \right)^{1/2} \left(2\pi \log \frac{r_2}{r_1} \right)^{1/2} \quad \text{using (92)} \end{aligned}$$

The proposition follows. \square

The next proposition is useful to find circles on which we have a good estimate of $\int |df|$.

A.6. Proposition. *Under the same hypotheses as proposition A.5, consider some point $p \in \Omega$. Given $0 < r'_1 < r'_2$, there exists $r \in [r'_1, r'_2]$ such that*

$$\int_{C(p,r) \cap \Omega} |df| \leq \sqrt{8}\phi \left(\log \frac{r_2}{r_1} \right)^{1/2} \left(\log \frac{r'_2}{r'_1} \right)^{-1/2}.$$

Proof. Consider the function

$$F(r) = \int_{C(p,r) \cap \Omega} |df| = \int_{\theta=0}^{2\pi} \rho(p + re^{i\theta}) r d\theta.$$

Then

$$\begin{aligned} &\min_{r'_1 \leq r \leq r'_2} F(r) \log \frac{r'_2}{r'_1} \\ &\leq \int_{r=r'_1}^{r'_2} \frac{F(r)}{r} dr \\ &= \int_{r=r'_1}^{r'_2} \int_{\theta=0}^{2\pi} \frac{\rho(p + re^{i\theta})}{r} r dr d\theta \\ &\leq \left(\int_{r'_1}^{r'_2} \int_0^{2\pi} \rho(p + re^{i\theta})^2 r dr d\theta \right)^{1/2} \left(\int_{r'_1}^{r'_2} \int_0^{2\pi} \frac{1}{r^2} r dr d\theta \right)^{1/2} \\ &\leq \left(\int_A \rho^2 dx dy \right)^{1/2} \left(2\pi \log \frac{r'_2}{r'_1} \right)^{1/2} \\ &\leq \left(8\phi^2 \log \frac{r_2}{r_1} \log \frac{r'_2}{r'_1} \right)^{1/2} \quad \text{using (92) and proposition A.5.} \end{aligned}$$

The proposition follows. \square

A LAURENT-TYPE FORMULA FOR C^1 FUNCTIONS

A.7. Proposition. *Let $\Omega \subset \mathbf{C}$ be a domain of the form*

$$\Omega = D(0, R) \setminus \bigcup_{i=1}^n \overline{D}(p_i, r_i).$$

Here we assume that the closed disks $\overline{D}(p_i, r_i)$ are disjoint and are included in $D(0, R)$. Let g be a C^1 function on $\overline{\Omega}$. Then in Ω ,

$$g(z) = g^+(z) + \sum_{i=1}^n g_i^-(z) + \frac{1}{2\pi i} \int_{\Omega} \frac{g_{\bar{z}}(w)}{w-z} dw \wedge \overline{dw}$$

where g^+ is holomorphic in $D(0, R)$ and each g_i^- is holomorphic in $\mathbf{C} \setminus \overline{D}(p_i, r_i)$. Moreover, these functions have the following series expansions:

$$g^+(z) = \sum_{k=0}^{\infty} a_k z^k \quad \text{with } a_k = \frac{1}{2\pi i} \int_{C(0,R)} \frac{g(z)}{z^{k+1}} dz,$$

$$g_i^-(z) = \sum_{k=1}^{\infty} \frac{a_{i,k}}{(z-p_i)^k} \quad \text{with } a_{i,k} = \frac{1}{2\pi i} \int_{C(p_i,r_i)} g(z)(z-p_i)^{k-1} dz.$$

The series converge uniformly in compact subsets of Ω .

Remark. This is the same as the Laurent series theorem except that there is a correction term which vanishes when g is holomorphic. The integration circles in the formula for a_n and $a_{i,n}$ cannot be changed (as in the classical Laurent series theorem) since g is not assumed to be holomorphic.

Proof. By the Cauchy Pompeiu integral formula for C^1 functions:

$$(93) \quad g(z) = \frac{1}{2\pi i} \int_{\partial\Omega} \frac{g(w)}{w-z} dw + \frac{1}{2\pi i} \int_{\Omega} \frac{g_{\bar{z}}(w)}{w-z} dw \wedge \overline{dw}.$$

Define

$$g^+(z) = \frac{1}{2\pi i} \int_{C(0,R)} \frac{g(w)}{w-z} dw, \quad g_i^-(z) = -\frac{1}{2\pi i} \int_{C(p_i,r_i)} \frac{g(w)}{w-z} dw.$$

The function g^+ is holomorphic in $D(0, R)$. The function g_i^- is holomorphic in $\mathbf{C} \setminus D(p_i, r_i)$ and extends at ∞ with $g_i^-(\infty) = 0$. These two functions are expanded in power series exactly as in the proof of the classical theorem on Laurent series (see e.g. [Con78], page 107). \square

A.8. Proposition. *Let $\Omega \subset \mathbf{C}$ be a domain as in proposition A.7. Let $u : \Omega \rightarrow \mathbf{R}$ be a real-valued function of class C^2 . Take $g = \partial u / \partial z$. Then the coefficients $a_{i,1}$ which appear in the conclusion of proposition A.7 are real.*

Proof.

$$\begin{aligned} \operatorname{Im} a_{i,1} &= \frac{-1}{2\pi} \operatorname{Re} \int_{C(p_i,r_i)} u_z dz \\ &= \frac{-1}{4\pi} \int_{C(p_i,r_i)} u_z dz + u_{\bar{z}} d\bar{z} \quad \text{because } u \text{ is real valued} \\ &= \frac{-1}{4\pi} \int_{C(p_i,r_i)} du = 0 \quad \text{because } u \text{ is well defined in } \Omega. \end{aligned}$$

□

RESIDUE COMPUTATION

A.9. Proposition.

$$\operatorname{Res}_p(\log z - \log p)^{-1} = p, \quad \operatorname{Res}_p\left(\frac{1 - z^2}{4z^2}\right)(\log z - \log p)^{-2} = -\frac{1 + p^2}{4p}.$$

Proof.

$$\log z - \log p = \log\left(1 + \frac{z - p}{p}\right) = \frac{z - p}{p} - \frac{1}{2}\left(\frac{z - p}{p}\right)^2 + O(z - p)^3$$

The first residue follows. By the binomial theorem,

$$(\log z - \log p)^{-2} = \frac{p^2}{(z - p)^2} + \frac{p}{z - p} + O(1).$$

Let

$$f(z) = \frac{1 - z^2}{4z^2} = \frac{1}{4z^2} - \frac{1}{4}.$$

Then

$$\begin{aligned} \operatorname{Res}_p\left(\frac{1 - z^2}{4z^2}(\log z - \log p)^{-2}\right) &= \operatorname{Res}_p\left(\frac{f(z)p^2}{(z - p)^2}\right) + \operatorname{Res}_p\left(\frac{f(z)p}{z - p}\right) \\ &= f'(p)p^2 + f(p)p \quad (\text{by the Taylor expansion for } f \text{ at } p) \\ &= -\frac{1}{2p^3}p^2 + \frac{1 - p^2}{4p} \\ &= -\frac{1 + p^2}{4p}. \end{aligned}$$

□

REFERENCES

- [All72] William K. Allard, *On the first variation of a varifold*, Ann. of Math. (2) **95** (1972), 417–491. MR0307015, Zbl 0252.49028. ↑38
- [All75] ———, *On the first variation of a varifold: boundary behavior*, Ann. of Math. (2) **101** (1975), 418–446. MR0397520 (53 #1379) ↑13
- [And85] Michael T. Anderson, *Curvature estimates for minimal surfaces in 3-manifolds*, Ann. Sci. École Norm. Sup. (4) **18** (1985), no. 1, 89–105. MR803196 (87e:53098) ↑32
- [ABR01] Sheldon Axler, Paul Bourdon, and Wade Ramey, *Harmonic function theory*, 2nd ed., Graduate Texts in Mathematics, vol. 137, Springer-Verlag, New York, 2001. MR1805196 (2001j:31001) ↑64
- [Ber11] Jacob and Breiner Bernstein Christine, *Conformal structure of minimal surfaces with finite topology*, Comment. Math. Helv. **86** (2011), no. 2, 353–381, DOI 10.4171/CMH/226. ↑1, 46
- [Bob98] Alexander I. Bobenko, *Helicoids with handles and Baker-Akhiezer spinors*, Math. Z. **229** (1998), no. 1, 9–29, DOI 10.1007/PL00004652. MR1649381 (2001d:53009) ↑1
- [CS85] Hyeon In Choi and Richard Schoen, *The space of minimal embeddings of a surface into a three-dimensional manifold of positive Ricci curvature*, Invent. Math. **81** (1985), no. 3, 387–394, DOI 10.1007/BF01388577. MR807063 (87a:58040) ↑32
- [Con78] John B. Conway, *Functions of one complex variable*, 2nd ed., Graduate Texts in Mathematics, vol. 11, Springer-Verlag, New York-Berlin, 1978. MR503901 (80c:30003) ↑84
- [FCS80] Doris Fischer-Colbrie and Richard Schoen, *The structure of complete stable minimal surfaces in 3-manifolds of nonnegative scalar curvature*, Comm. Pure Appl. Math. **33** (1980), no. 2, 199–211, DOI 10.1002/cpa.3160330206. MR562550 (81i:53044) ↑33

- [GT01] David Gilbarg and Neil S. Trudinger, *Elliptic partial differential equations of second order*, Classics in Mathematics, Springer-Verlag, Berlin, 2001. Reprint of the 1998 edition. MR1814364 ↑8
- [Gul76] Robert Gulliver, *Removability of singular points on surfaces of bounded mean curvature*, J. Differential Geometry **11** (1976), no. 3, 345–350. MR0431045 (55 #4047) ↑13
- [Hil69] Stefan Hildebrandt, *Boundary behavior of minimal surfaces*, Arch. Rational Mech. Anal. **35** (1969), 47–82. MR0248650 (40 #1901) ↑13
- [HKW93] David Hoffman, Hermann Karcher, and Fu Sheng Wei, *The genus one helicoid and the minimal surfaces that led to its discovery*, Global analysis in modern mathematics (Orono, ME, 1991; Waltham, MA, 1992), 1993, pp. 119–170. ↑1
- [HW02] David Hoffman and Fusheng Wei, *Deforming the singly periodic genus-one helicoid*, Experiment. Math. **11** (2002), no. 2, 207–218. ↑
- [HW08] David Hoffman and Brian White, *Genus-one helicoids from a variational point of view*, Comment. Math. Helv. **83** (2008), no. 4, 767–813. MR2442963 (2010b:53013) ↑1
- [HW09] ———, *The geometry of genus-one helicoids*, Comment. Math. Helv. **84** (2009), no. 3, 547–569, DOI 10.4171/CMH/172. MR2507253 (2010f:53013) ↑46
- [HW08] ———, *On the number of minimal surfaces with a given boundary*, Astérisque **322** (2008), 207–224 (English, with English and French summaries). Géométrie différentielle, physique mathématique, mathématiques et société. II. MR2521657 (2010h:53007) ↑9, 30, 31
- [HW11] ———, *Axial minimal surfaces in $S^2 \times \mathbf{R}$ are helicoidal*, J. Differential Geom. **87** (2011), no. 3, 515–523. MR2819547 ↑36
- [LR91] Francisco J. López and Antonio Ros, *On embedded complete minimal surfaces of genus zero*, J. Differential Geom. **33** (1991), no. 1, 293–300. MR1085145 (91k:53019) ↑40
- [MP15] William H. Meeks III and Joaquín Pérez, *Embedded minimal surfaces of finite topology* (2015). Preprint at arXiv:1506.07793 [math.DG]. ↑1, 46
- [MR05a] William H. Meeks III and Harold Rosenberg, *The uniqueness of the helicoid*, Ann. of Math. (2) **161** (2005), no. 2, 727–758, DOI 10.4007/annals.2005.161.727. MR2153399 (2006f:53012) ↑1
- [MR05b] William H. Meeks and Harold Rosenberg, *The theory of minimal surfaces in $\mathbb{M} \times \mathbb{R}$* , Comment. Math. Helv. **80** (2005), no. 4, 811–858. MR2182702, Zbl 1085.53049. ↑3
- [Ros02] Harold Rosenberg, *Minimal surfaces in $\mathbb{M}^2 \times \mathbb{R}$* , Illinois J. Math. **46** (2002), no. 4, 1177–1195. MR1988257, Zbl 1036.53008. ↑3, 7, 35
- [Sch83] Richard M. Schoen, *Uniqueness, symmetry, and embeddedness of minimal surfaces*, J. Differential Geom. **18** (1983), no. 4, 791–809 (1984). MR730928 (85f:53011) ↑41, 79
- [Sch05] Markus Schmies, *Computational methods for Riemann surfaces and helicoids with handles*, Ph.D. Thesis, Technische Universität Berlin, 2005. ↑1
- [Sma87] Nathan Smale, *A bridge principle for minimal and constant mean curvature submanifolds of \mathbf{R}^N* , Invent. Math. **90** (1987), no. 3, 505–549, DOI 10.1007/BF01389177. MR914848 (88i:53101) ↑18
- [Tra04] Martin Traizet, *A balancing condition for weak limits of families of minimal surfaces*, Comment. Math. Helv. **79** (2004), no. 4, 798–825, DOI 10.1007/s00014-004-0805-1. MR2099123 (2005g:53017) ↑56
- [Tra10] ———, *On minimal surfaces bounded by two convex curves in parallel planes*, Comment. Math. Helv. **85** (2010), no. 1, 39–71, DOI 10.4171/CMH/187. MR2563680 (2010k:53012) ↑56
- [WHW09] Matthias Weber, David Hoffman, and Michael Wolf, *An embedded genus-one helicoid*, Ann. of Math. (2) **169** (2009), no. 2, 347–448, DOI 10.4007/annals.2009.169.347. ↑1
- [Whi87] Brian White, *Curvature estimates and compactness theorems in 3-manifolds for surfaces that are stationary for parametric elliptic functionals*, Invent. Math. **88** (1987), no. 2, 243–256, DOI 10.1007/BF01388908. MR880951 (88g:58037) ↑17, 27, 32
- [Whi94a] ———, *The bridge principle for stable minimal surfaces*, Calc. Var. Partial Differential Equations **2** (1994), no. 4, 405–425, DOI 10.1007/BF01192091. MR1383916 (97d:49043) ↑18
- [Whi94b] ———, *The bridge principle for unstable and for singular minimal surfaces*, Comm. Anal. Geom. **2** (1994), no. 4, 513–532. MR1336893 (96k:49063) ↑18

- [Whi09] ———, *Which ambient spaces admit isoperimetric inequalities for submanifolds?*, J. Differential Geom. **83** (2009), no. 1, 213–228. MR2545035 ↑15, 16
- [Whi16] ———, *Controlling area blow-up in minimal or bounded mean curvature varieties*, J. Differential Geom. **102** (2016), no. 3, 501–535. MR3466806 ↑19, 25, 26, 38, 46
- [Whi17a] ———, *On the compactness theorem for embedded minimal surfaces in 3-manifolds with locally bounded area and genus*, Comm. Anal. Geom. (2017). To appear. Preprint at arXiv:1503.02190 [math.DG]. ↑33
- [Whi17b] ———, *On the bumpy metrics theorem for minimal submanifolds*, American J. Math. (2017). To appear. Preprint at arXiv:1503.01803 [math.DG]. ↑17

DEPARTMENT OF MATHEMATICS, STANFORD UNIVERSITY, STANFORD, CA 94305
E-mail address: `dhoffman@stanford.edu`

LABORATOIRE DE MATHÉMATIQUES ET PHYSIQUE THÉORIQUE, UNIVERSITÉ FRANÇOIS RABELAIS,
37200 TOURS, FRANCE
E-mail address: `Martin.Traizet@lmpt.univ-tours.fr`

DEPARTMENT OF MATHEMATICS, STANFORD UNIVERSITY, STANFORD, CA 94305
E-mail address: `bcwhite@stanford.edu`